

SWITCHING APPLICATION.  
INTERFACE CIRCUIT AND DRIVER  
CIRCUIT APPLICATION.

#### FEATURES

- With Built-in Bias Resistors.
- Simplify Circuit Design.
- Reduce a Quantity of Parts and Manufacturing Process.

#### EQUIVALENT CIRCUIT

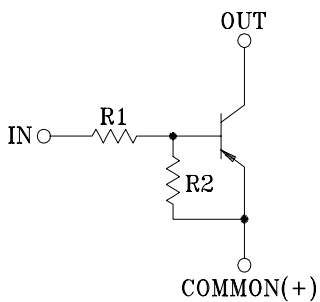

#### BIAS RESISTOR VALUES

TYPE NO.	R1(kΩ)	R2(kΩ)
KRA107M	10	47
KRA108M	22	47
KRA109M	47	22

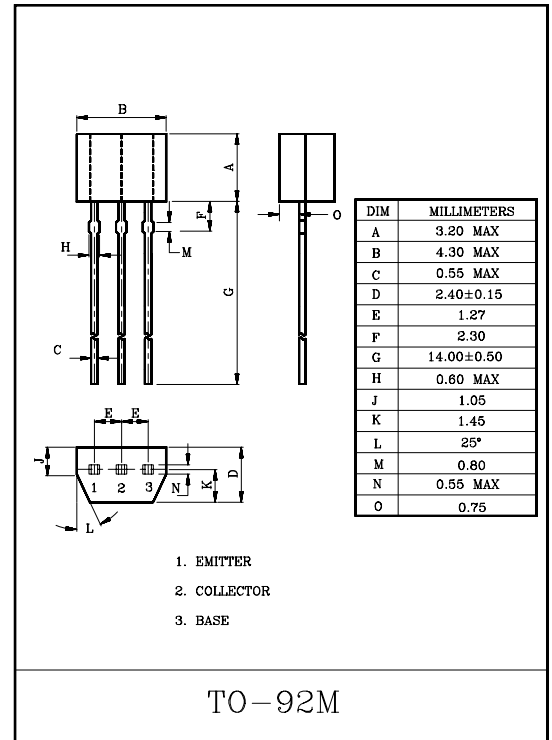

#### MAXIMUM RATINGS(Ta=25°C)

CHARACTERISTIC		SYMBOL	RATING	UNIT
Output Voltage	KRA107M ~109M	V <sub>O</sub>	-50	V
Input Voltage	KRA107M	V <sub>I</sub>	-30, 6	V
	KRA108M		-40, 7	
	KRA109M		-40, 15	
Output Current	KRA107M ~109M	I <sub>O</sub>	-100	mA
Power Dissipation		P <sub>D</sub>	400	mW
Junction Temperature		T <sub>j</sub>	150	°C
Storage Temperature Range		T <sub>stg</sub>	-55~150	°C

# KRA107M~KRA109M

## ELECTRICAL CHARACTERISTICS (Ta=25°C)

CHARACTERISTIC		SYMBOL	TEST CONDITION	MIN.	TYP.	MAX.	UNIT	
Output Cut-off Current	KRA107M~109M	$I_{O(OFF)}$	$V_O=-50V, V_I=0$	-	-	-500	nA	
DC Current Gain	KRA107M	$G_I$	$V_O=-5V, I_O=-10mA$	80	150	-		
	KRA108M			80	150	-		
	KRA109M			70	140	-		
Output Voltage	KRA107M~109M	$V_{O(ON)}$	$I_O=-10mA, I_I=-0.5mA$	-	-0.1	-0.3	V	
Input Voltage (ON)	KRA107M	$V_{I(ON)}$	$V_O=-0.2V, I_O=-5mA$	-	-1.2	-1.8	V	
	KRA108M			-	-1.8	-2.6		
	KRA109M			-	-3.0	-5.8		
Input Voltage (OFF)	KRA107M	$V_{I(OFF)}$	$V_O=-5V, I_O=-0.1mA$	-0.5	-0.75	-	V	
	KRA108M			-0.6	-0.88	-		
	KRA109M			-1.5	-1.82	-		
Transition Frequency	KRA107M~109M	$f_T *$	$V_O=-10V, I_O=-5mA$	-	200	-	MHz	
Input Current	KRA107M	$I_I$	$V_I=-5V$	-	-	-0.88	mA	
	KRA108M			-	-	-0.36		
	KRA109M			-	-	-0.16		
Switching Time	Rise Time	$t_r$	$V_O=-5V$ $V_{IN}=-5V$ $R_L=1k\Omega$	-	0.07	-	$\mu S$	
				KRA108M	-	0.20		-
				KRA109M	-	0.38		-
	Storage Time	$t_{stg}$		KRA107M	-	1.1		-
				KRA108M	-	0.3		-
				KRA109M	-	0.7		-
	Fall Time	$t_f$		KRA107M	-	0.35		-
				KRA108M	-	0.4		-
				KRA109M	-	0.48		-

Note : \*Characteristic of Transistor Only

# KRA107M ~ KRA109M

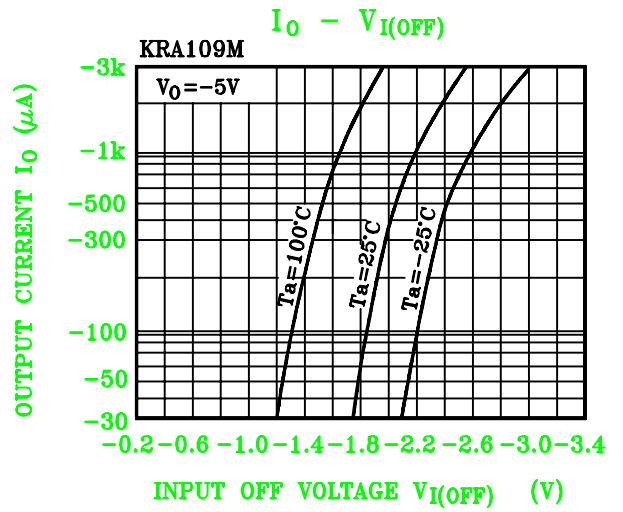
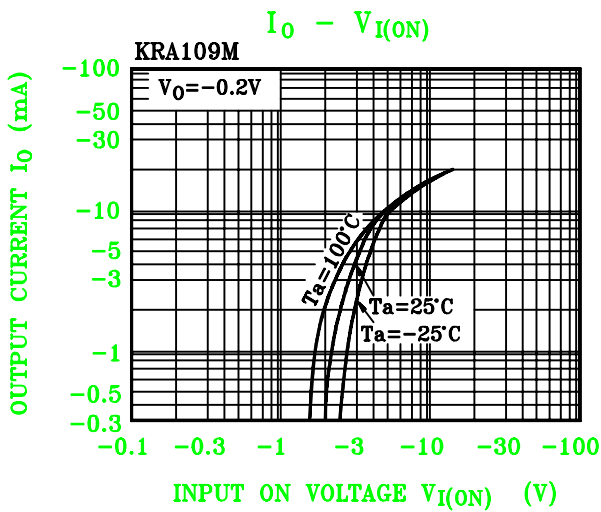
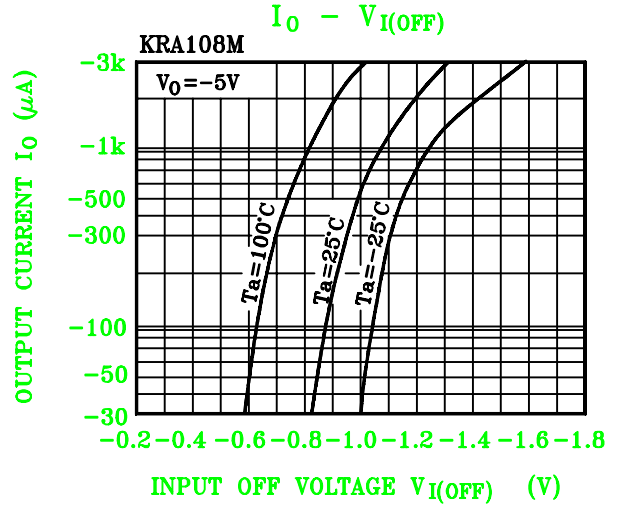
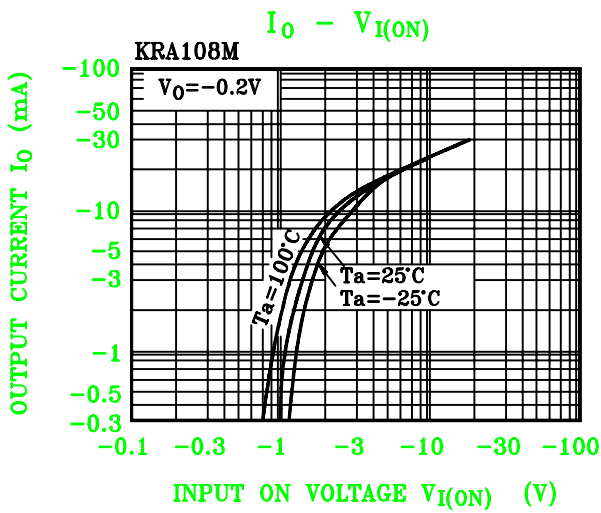
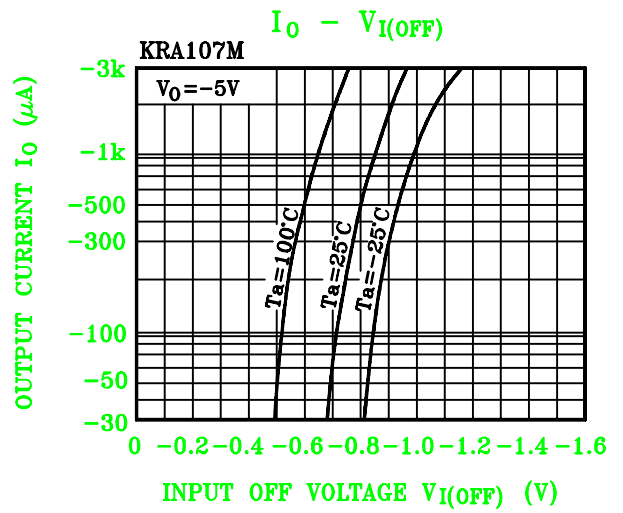
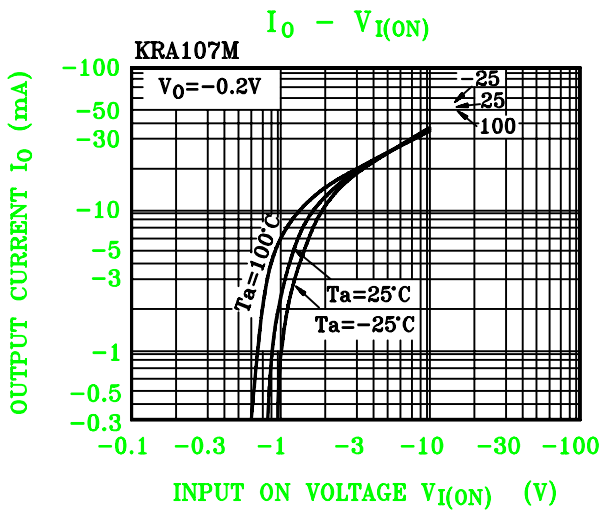

# KRA107M ~ KRA109M

