



SPECIFICATIONS

CUSTOMER	:	PTC
SAMPLE CODE	:	SG24064WRF-EGAH16Q
MASS PRODUCTION CODE	:	PG24064WRF-EGAH16Q
SAMPLE VERSION	:	01
SPECIFICATIONS EDITION	:	004
DRAWING NO. (Ver.)	:	HLMD-PG24064WRF-EGAH16Q_001
PACKAGING NO. (Ver.)	:	JPKG-PG24064WRF-EGAH16Q_002

Customer Approved

Date:

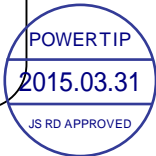

Approved	Checked	Designer
閔偉	劉進	張斌

- Preliminary specification for design input
- Specification for sample approval

POWERTIP TECH. CORP.

Headquarters: No.8, 6 th Road, Taichung Industrial Park, Taichung, Taiwan 台中市 407 工業區六路 8 號	TEL: 886-4-2355-8168 FAX: 886-4-2355-8166	E-mail: sales@powertip.com.tw Http://www.powertip.com.tw
---	--	---

RECORDS OF REVISION

Date (mm / dd / yyyy)	Ver.	Edi.	Description	Page	Design by
08/31/2009	01	001	New sample	-	楊清龍
11/19/2009	01	002	Change the resistance of base circuit for customer order		黃傑峰
12/18/2009	01	003	Modify The Jumper	15	Jacob
03/25/2015	01	004	Modify The LCD Driver Supply Voltage	4	張斌

Total : 26page

Contents

1. SPECIFICATIONS

- 1.1 Features**
- 1.2 Mechanical Specifications**
- 1.3 Absolute Maximum Ratings**
- 1.4 DC Electrical Characteristics**
- 1.5 Optical Characteristics**
- 1.6 Backlight Characteristics**

2. MODULE STRUCTURE

- 2.1 Counter Drawing**
- 2.2 Interface Pin Description**
- 2.3 Timing Characteristics**
- 2.4 Display command**
- 2.5 JUMPER**

3. QUALITY ASSURANCE SYSTEM

- 3.1 Quality Assurance Flow Chart**
- 3.2 Inspection Specification**

4. RELIABILITY TEST

- 4.1 Reliability Test Condition**

5. PRECAUTION RELATING PRODUCT HANDLING

- 5.1 Safety**
- 5.2 Handling**
- 5.3 Storage**
- 5.4 Terms of Warranty**

- Appendix: **1. LCM Drawing**
2. Packing Specification

1. SPECIFICATIONS

1.1 Features

Item	Standard Value
Display Type	240*64 Dots
LCD Type	FSTN,White,Positive,Transflective,Extended Temp.
Driver Condition	LCD Module : 1/64 Duty , 1/9 Bias
Viewing Direction	6 O'clock
Weight	174 g
Interface	8080-series 8-bits parallel data bus
Other(controller / driver IC)	SAP1024B
ROHS	THIS PRODUCT CONFORMS THE ROHS OF PTC Detail information please refer web side : http://www.powertip.com.tw/news.php?area_id_view=1085560481/

1.2 Mechanical Specifications

Item	Standard Value	Unit
Outline Dimension	180.0 (L) *65.0 (w) * 15.5(H)(Max)	mm
Viewing Area	132.6.0(L) * 39.0(w)	mm
Active Area	127.16(L) * 33.88 (w)	mm
Dot Size	0.49 (L) * 0.49(w)	mm
Dot Pitch	0.53 (L) * 0.53 (w)	mm

Note : For detailed information please refer to LCM drawing

1.3 Absolute Maximum Ratings

Item	Symbol	Condition	Min.	Max.	Unit
Power Supply Voltage	V _{DD}	—	-0.3	7.0	V
LCD Driver Supply Voltage	V _{LCD}	—	0	30	V
Input Voltage	V _{IN}	—	-0.3	V _{DD} +0.3	V
Operating Temperature	T _{OP}	—	-20	70	°C
Storage Temperature	T _{ST}	—	-30	80	°C
Storage Humidity	H _D	Ta < 60 °C	-	90	%RH

1.4 DC Electrical Characteristics

$V_{DD}=5.0\text{ V} \pm 10\%$, $V_{SS} = 0\text{V}$, $T_a = 25^\circ\text{C}$

Item	Symbol	Condition	Min.	Typ.	Max.	Unit
Logic Supply Voltage	V_{DD}	-	4.5	5.0	5.5	V
“H” Input Voltage	V_{IH}	-	$V_{DD}-2.2$	-	V_{DD}	V
“L” Input Voltage	V_{IL}	-	0	-	0.8	V
“H” Output Voltage	V_{OH}	-	$V_{DD}-0.3$	-	V_{DD}	V
“L” Output Voltage	V_{OL}	-	0	-	0.3	V
Supply Current	I_{dd}	$V_{DD}=5.0\text{V}; V_{OP}=12.0\text{V};$ Pattern= Full display	-	19	-	mA
		$V_{DD}=5.0\text{V}; V_{OP}=12.0\text{V};$ Pattern= Horizontal line*1	-	20	30	
LCM Driver Voltage	V_{OP*2}	-20°C	12.0	12.2	12.4	V
		25°C	11.8	12.0	12.2	
		70°C	11.6	11.8	12.0	

NOTE: *1 The Maximum current display;

*2 The VOP test point is $V_{DD}-V_O$.

1.5 Optical Characteristics

LCD Panel : 1/64Duty , 1/9Bias , $V_{LCD}=12.7V$, $T_a = 25^{\circ}C$

Item	Symbol	Conditions	Min.	Typ.	Max.	Unit	Reference
Response Time	Rise	tr	-	150	-	ms	Note2
	Fall	tf	-	300	-		
Viewing angle range	Top	$\Theta Y+$	-	-	40	Deg.	Notes 1
	Bottom	$\Theta Y-$	-	-	40		
	Left	$\Theta X-$	-	-	45		
	Right	$\Theta X+$	-	-	45		
Contrast Ratio	C	$\theta = 0^{\circ}$, $\angle E = 270^{\circ}$	4	6	-	-	Note 3
Average Brightness (with LCD) *2	IV	IF=90mA	36	-	-	cd/m2	Note 4
CIE Color Coordinate (With LCD)*2	x		0.24	0.29	0.34	nm	
	y		0.25	0.30	0.35		
Uniformity *1	ΔB		70	-	-	%	

Note 4 :

1 : $\Delta B = B(\min) / B(\max) * 100\%$

2 : Measurement Condition for Optical Characteristics:

a : Environment: $25^{\circ}C \pm 5^{\circ}C$ / $60 \pm 20\%$ R.H , no wind , dark room below 10 Lux at typical lamp current and typical operating frequency.

b : Measurement Distance: 500 ± 50 mm , ($\theta = 0^{\circ}$)

c : Equipment: TOPCON BM-7 fast , (field 1°) , after 10 minutes operation.

d : The uncertainty of the C.I.E coordinate measurement ± 0.01 , Average Brightness $\pm 4\%$

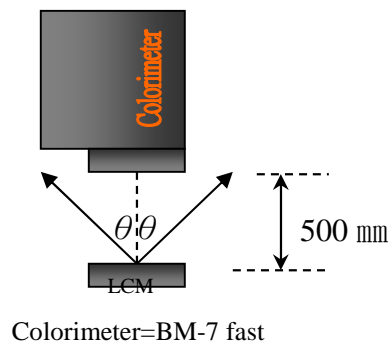
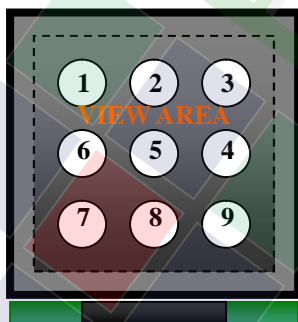

Note 1.

Optical characteristics-2

Viewing angle

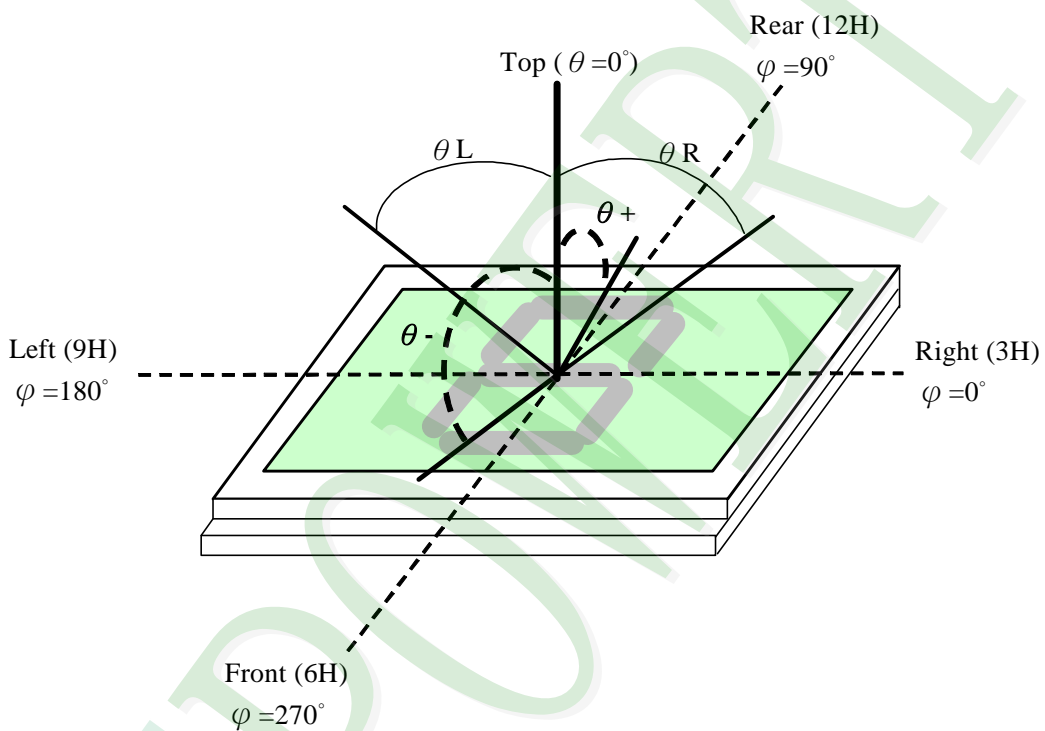

Viewing angle

Note 2.

Optical characteristics-3

Fig.2 Definition of response time

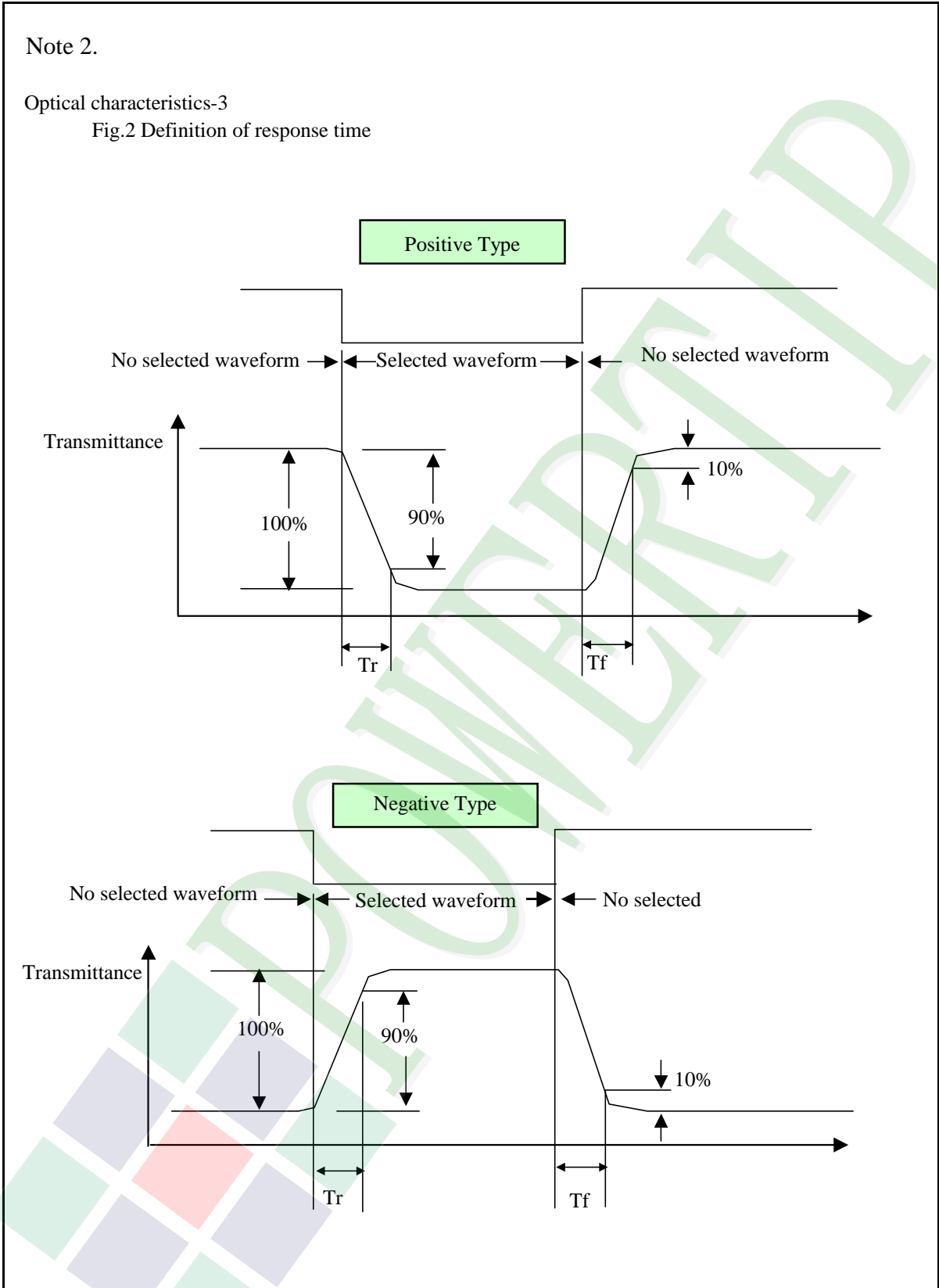

Electrical characteristics-2

※2 Drive waveform

V_{op} : Drive voltage

f_F : Frame frequency

$1/B$: Bias

f_D : Drive frequency

N: Duty

(1) Selected waveform

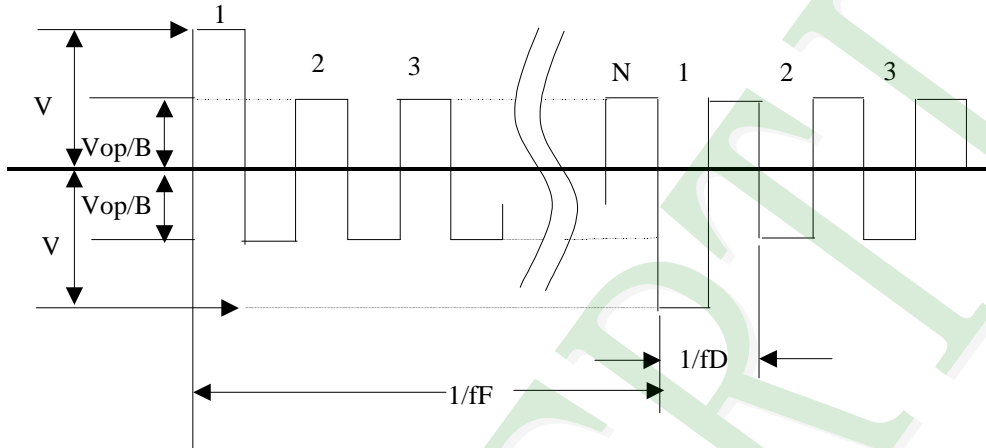

(2) Non- Selected wave form

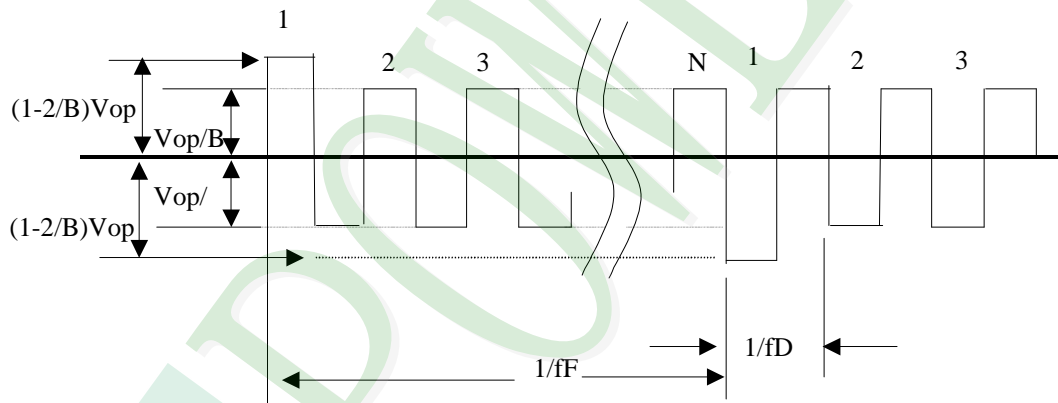

Note:

Frame frequency is defined as follows: Common side supply voltage peak - to - peak / 2 = 1 period

Note 3. : Definition of Vth

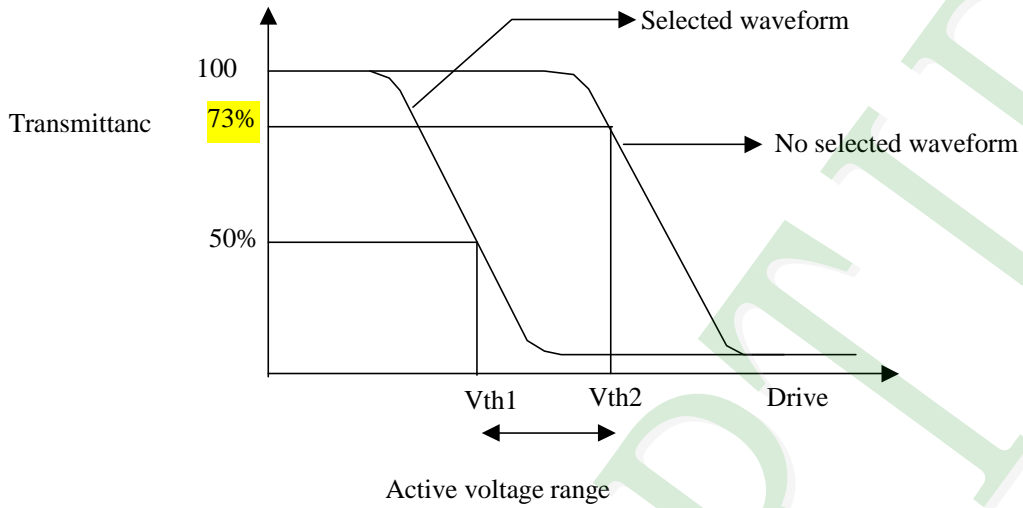

	Vth1	Vth2
View direction	10°	40°
Drive waveform	(Selected waveform)	(No selected waveform)
Transmittance	50%	73%

※1 Contrast ratio
 = (Brightness in OFF state) / (Brightness in ON state)

Outline of Electro-Optical Characteristics Measuring System

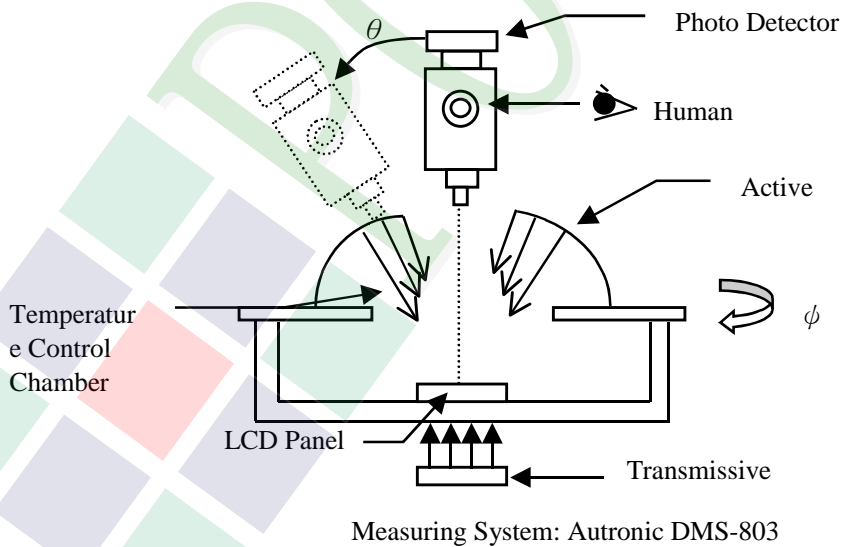

1.6 Backlight Characteristics

LCD Module with LED Backlight

Maximum Ratings

Item	Symbol	Conditions	Min.	Max.	Unit
Forward Current	IF	Ta =25°C	-	150	mA
Reverse Voltage	VR	Ta =25°C	-	5.0	V
Reverse Current	IR	VR=3.0V	-	10	uA
Power Dissipation	PD	Ta =25°C	-	675	mW

Electrical / Optical Characteristics

Item	Symbol	Conditions	Min.	Typ.	Max.	Unit
Forward Voltage	VF	IF=90mA	-	3.6	4.2	V
Average Brightness (without LCD)	IV		200	300	-	cd/m ²
CIE Color Coordinate (Without LCD)	X	IF=90mA	0.264	0.28	0.296	-
	Y		0.248	0.29	0.305	
Color	white					

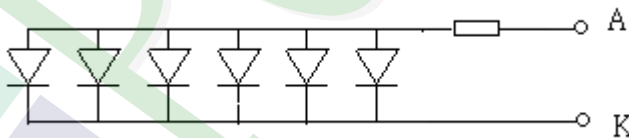

2. MODULE STRUCTURE

2.1 Counter Drawing

2.1.1 LCM Mechanical Diagram

* See Appendix

2.1.2 Block Diagram

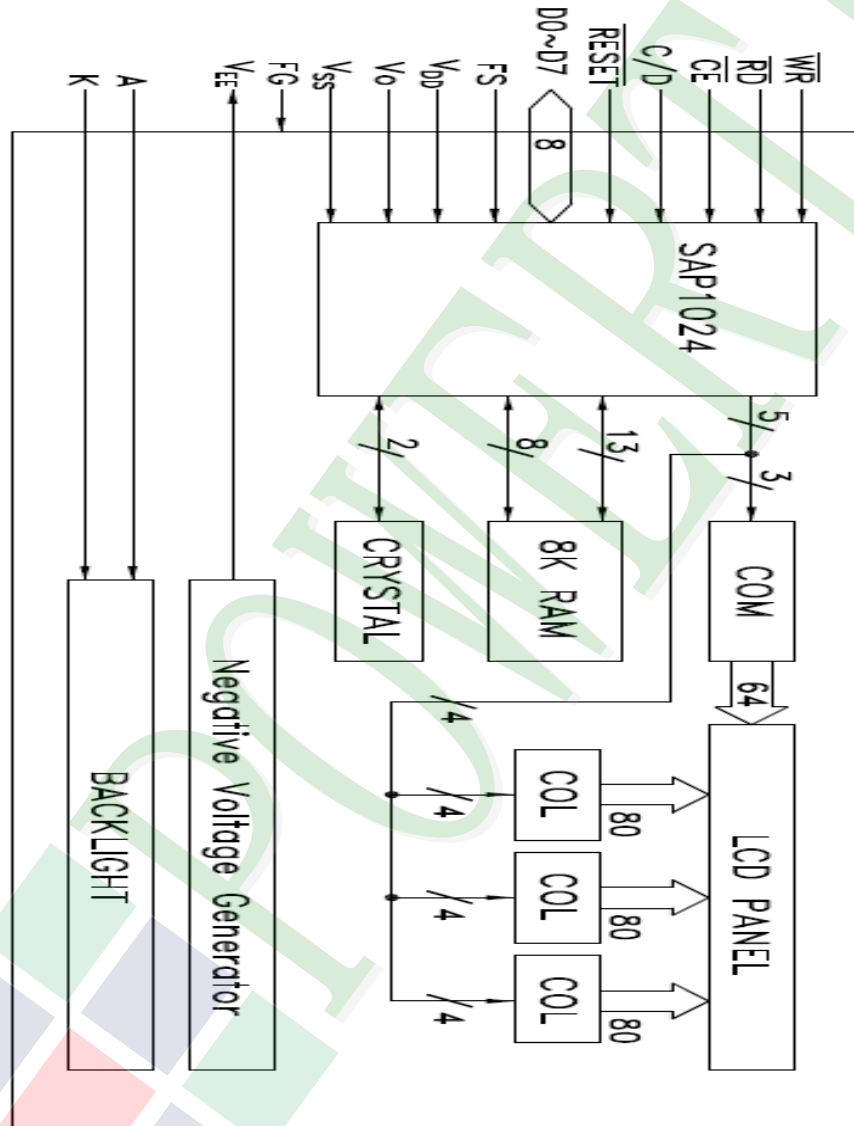

2.2 Interface Pin Description

Pin No.	Symbol	Function
1	FG	Frame ground (connected to metal bezel)
2	V _{SS}	Power Supply (V _{SS} =0)
3	V _{DD}	Power Supply (V _{DD} >V _{SS})
4	V _O	Operating voltage for LCD
5	$\overline{\text{WR}}$	Data write (write data to the module at "L")
6	$\overline{\text{RD}}$	Data read (read data from the module at "L")
7	$\overline{\text{CE}}$	Chip enable for the module (active at "L")
8	C/ $\overline{\text{D}}$	$\overline{\text{WR}} = "L"; \text{C}/ \overline{\text{D}} = "H" : \text{command write}, \text{C}/ \overline{\text{D}} = "L": \text{data write}$ $\overline{\text{RD}} = "L"; \text{C}/ \overline{\text{D}} = "H" : \text{command read}, \text{C}/ \overline{\text{D}} = "L": \text{data read}$
9	V _{EE}	Negative voltage output
10	$\overline{\text{RESET}}$	Controller reset (module reset)
11	DB0	Data bus (DB0=LSB)
12	DB1	Data bus
13	DB2	Data bus
14	DB3	Data bus
15	DB4	Data bus
16	DB5	Data bus
17	DB6	Data bus
18	DB7	Data bus (DB7=MSB)
19	FS	Font select :connect to V _{DD} : 6*8 Dots font connect to V _{SS} : 8*8 Dots font
20	N/A	Not connection

Contrast Adjust

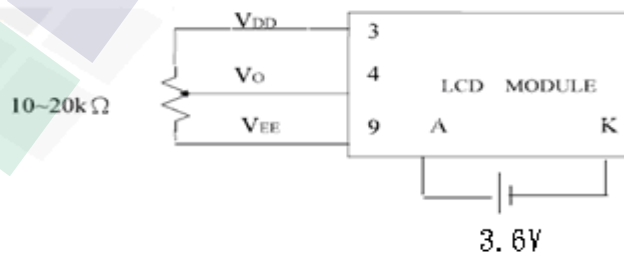

2.3 Timing Characteristics

Bus Timing

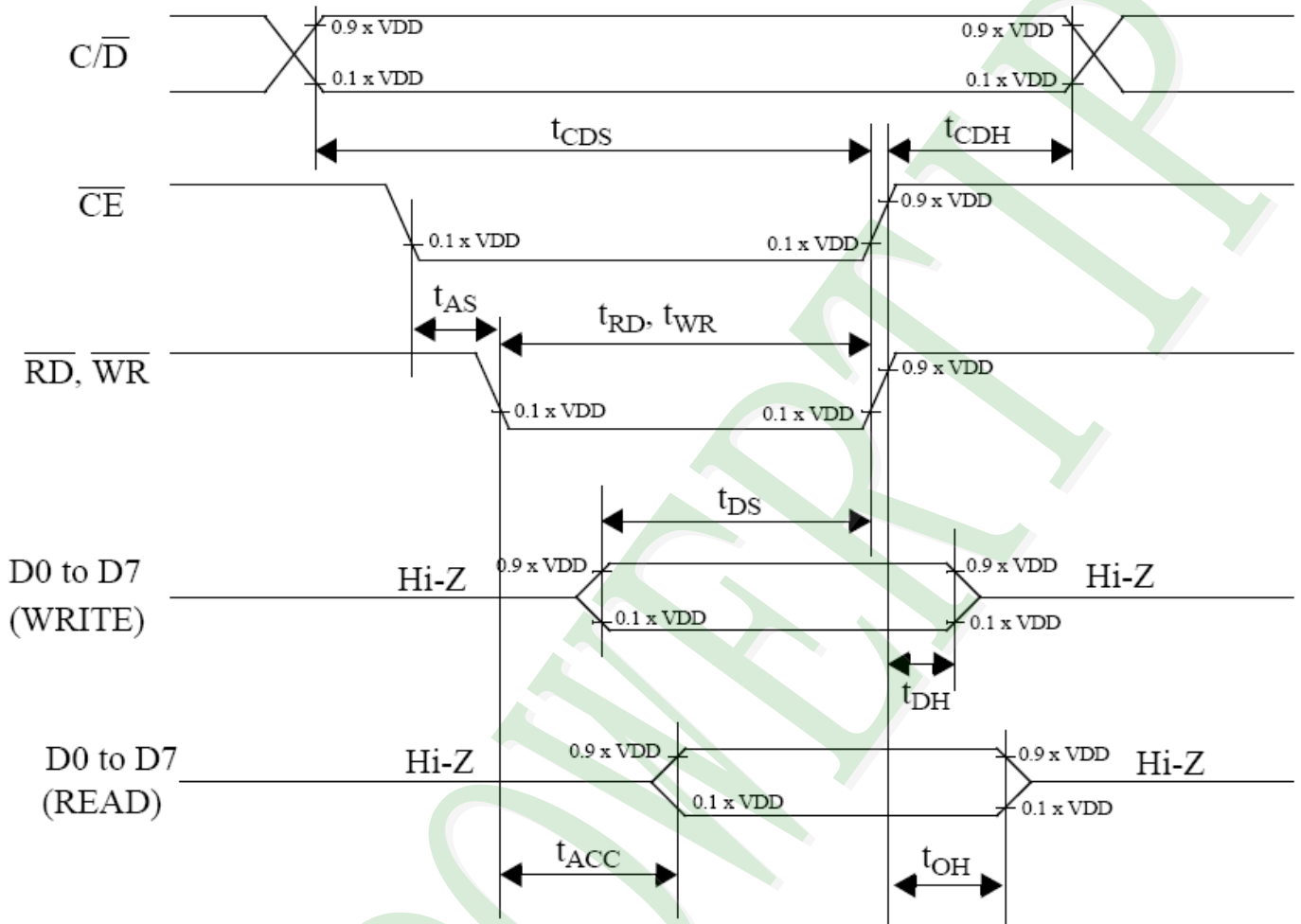

$V_{DD} = 5.0V \pm 0.5V$, $V_{SS} = 0V$, $T_a = 25^\circ C$

symbol	parameter	MIN.	MAX.	test conditons	Unit
t_{CDS}	C/\bar{D} set-up time	100			ns
t_{CDH}	C/\bar{D} hold time	10			ns
t_{RD}, t_{WR}	\overline{RD} , \overline{WR} pulse width	80			ns
t_{AS}	Address set-up time	0			ns
t_{AH}	Address hold time	0			ns
t_{DS}	Data set-up time	80			ns
t_{DH}	Data hold time	40			ns
t_{ACC}	Access time		150		ns
t_{OH}	Output hold time	10	50		ns

2.4 Display command

Commands and Registers.

COMMAND	CODE	OPERAND 1	OPERAND 2	FUNCTION
Register Setting	0010 0001	X address	Y address	Set cursor pointer
	0010 0010	Data	00H	Set offset register
	0010 0100	Low address	High address	Set address pointer
Set Control Word	0100 0000	Low address	High address	Set text home address
	0100 0001	Columns	00H	Set text area
	0100 0010	Low address	High address	Set graphic home address
	0100 0011	Columns	00H	Set graphic area
Mode Set	1000 x000			OR mode
	1000 x001			EXOR mode
	1000 x011			AND mode
	1000 x100			Text Attribute mode
	1000 0xxx			Internal CG ROM mode
	1000 1xxx			External CG RAM mode
Display mode	1001 0000			Display OFF.
	1001 xx10			Cursor ON, blink OFF.
	1001 xx11			Cursor ON, blink ON.
	1001 01xx			Text ON, graphic OFF.
	1001 10xx			Text OFF, graphic ON.
	1001 11xx			Text ON, graphic ON.
Cursor Pattern Select	1010 0000			Select one-line cursor.
	1010 0001			Select two-line cursor.
	1010 0010			Select three-line cursor.
	1010 0011			Select four-line cursor.
	1010 0100			Select five-line cursor.
	1010 0101			Select six-line cursor.
	1010 0110			Select seven-line cursor.
	1010 0111			Select eight-line cursor.
Data Auto Read/Write	1011 0000			Select Data Auto Write
	1011 0001			Select Data Auto Read
	1011 0010			Reset Auto Read/Write

COMMAND	CODE	OPERAND 1	OPERAND 2	FUNCTION
Data READ / WRITE	1100 0000	Data		Data Write and increment Address Pointer
	1100 0001			Data Read and increment Address Pointer
	1100 0010	Data		Data Write and decrement Address Pointer.
	1100 0011			Data Read and decrement Address Pointer
	1100 0100	Data		Data Write and Keep Address Pointer
	1100 0101			Data Read and Keep Address Pointer
Screen Peek	1110 0000			Screen peek
Screen Copy	1110 1000			Screen copy
Bit Set/Reset	1111 0xxxx			Bit Reset
	1111 1xxxx			Bit Set
	1111 x000			Bit 0
	1111 x001			Bit 1
	1111 x010			Bit 2
	1111 x011			Bit 3
	1111 x100			Bit 4
	1111 x101			Bit 5
	1111 x110			Bit 6
	1111 x111			Bit 7

2.5 JUMPER

JF1/JP2 (2.3) /JR/JEK/JA2/JEA: SHORT; OTHERS: OPEN

3. QUALITY ASSURANCE SYSTEM

3.1 Quality Assurance Flow Chart

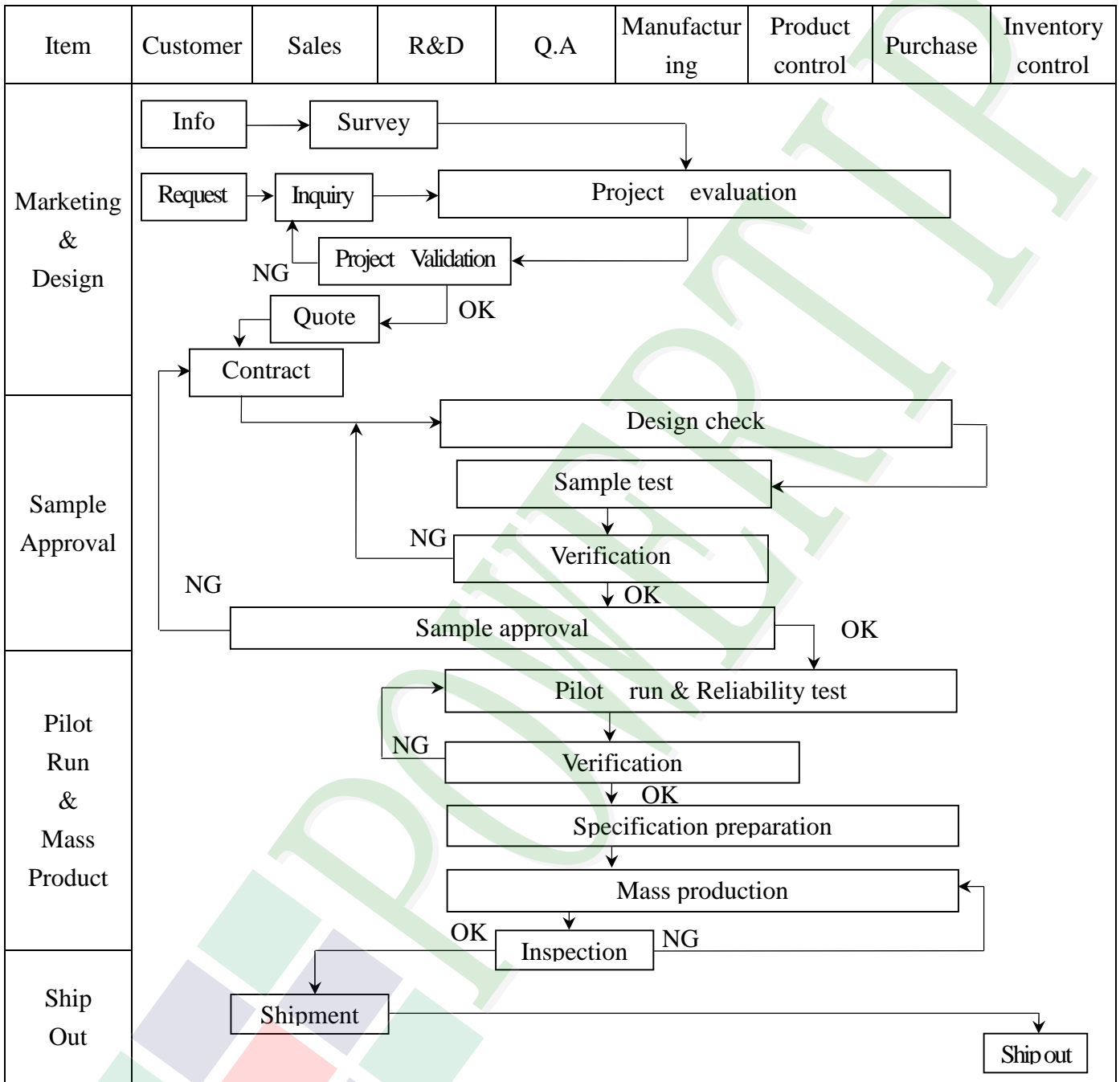

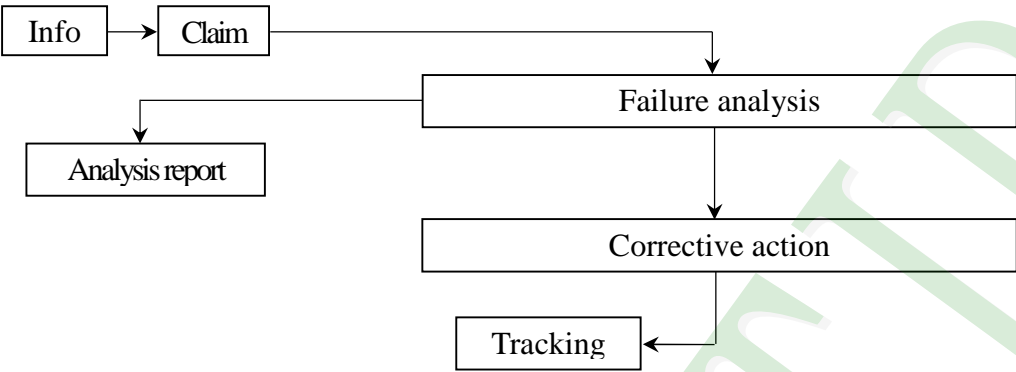
Item	Customer	Sales	R&D	Q.A	Manufacturing	Product control	Purchase	Inventory control
Sales Service	 <pre> graph TD Info[Info] --> Claim[Claim] Claim --> Failure[Failure analysis] Claim --> Report[Analysis report] Failure --> Action[Corrective action] Action --> Tracking[Tracking] </pre>							
Q.A Activity	1. ISO 9001 Maintenance Activities 3. Equipment calibration 5. Standardization Management				2. Process improvement proposal 4. Education And Training Activities			

3.2 Inspection Specification

◆ **Scope** : The document shall be applied to LCD Module for Monotype and Color STN (Ver. 03).

◆ **Inspection Standard** : MIL-STD-105E Table Normal Inspection Single Sampling Level II .

◆ **Equipment** : Gauge , MIL-STD , Powertip Tester , Sample

◆ **Defect Level** : Major Defect AQL : 0.4 ; Minor Defect : AQL : 1.5 .

◆ **OUT Going Defect Level** : Sampling .

◆ **Manner of appearance test** :

(1). The test be under 20W×2 fluorescent light ' and distance of view must be at 30 cm.

(2). Standard of inspection : (Unit : mm)

(3). The test direction is base on about around 45° of vertical line. (Fig. 1)

(4). Definition of area . (Fig. 2)

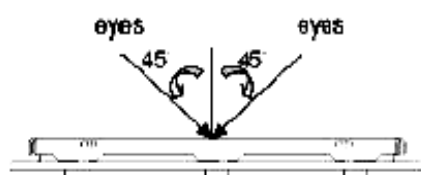

Fig. 1

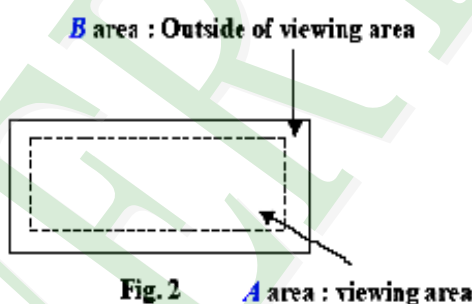

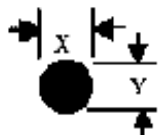

Fig. 2

◆ **Specification:**

NO	Item	Criterion	level
01	Product condition	1. 1 The part number is inconsistent with work order of Production.	Major
		1. 2 Mixed production types.	Major
		1. 3 Assembled in inverse direction.	Major
02	Quantity	2. 1 The quantity is inconsistent with work order of production.	Major
03	Outline dimension	3. 1 Product dimension and structure must conform to Structure diagram.	Major
04	Electrical Testing	4. 1 Missing line character and icon.	Major
		4. 2 No function or no display.	Major
		4. 3 Output data is error.	Major
		4. 4 LCD viewing angle defect.	Major
		4. 5 Current consumption exceeds product specifications.	Major

◆ Specification For Monotype and Color STN :

(Ver. 03)

NO	Item	Criterion	level																																				
05	Black or white dot , scratch , contamination Round type  $\Phi = (x+y)\sqrt{2}$ Line type 	5. 1 Round type: 5. 1. 1 display only : • White and black spots on display ≤ 0.30 mm , no more than 4 white or black spots present. • Densely spaced : NO more than two spots or lines within 3 mm. 5. 1. 2 Non-display : <table border="1" data-bbox="494 649 1316 1019"> <thead> <tr> <th rowspan="2">Dimension (diameter : Φ)</th> <th colspan="2">Acceptance (Q'ty)</th> </tr> <tr> <th>A area</th> <th>B area</th> </tr> </thead> <tbody> <tr> <td>$\Phi \leq 0.10$</td> <td colspan="2">Accept no dense</td> </tr> <tr> <td>$0.10 < \Phi \leq 0.20$</td> <td>3</td> <td rowspan="3">Ignore</td> </tr> <tr> <td>$0.20 < \Phi \leq 0.30$</td> <td>2</td> </tr> <tr> <td>Total quantity</td> <td>4</td> </tr> </tbody> </table> 5. 1. 3 Line type: <table border="1" data-bbox="446 1097 1364 1467"> <thead> <tr> <th colspan="2">Dimension</th> <th colspan="2">Acceptance (Q'ty)</th> </tr> <tr> <th>Length (L)</th> <th>Width (W)</th> <th>A area</th> <th>B area</th> </tr> </thead> <tbody> <tr> <td>---</td> <td>$W \leq 0.03$</td> <td>Accept no dense</td> <td rowspan="3">Ignore</td> </tr> <tr> <td>$L \leq 3.0$</td> <td>$0.03 < W \leq 0.05$</td> <td rowspan="2">4</td> </tr> <tr> <td>$L \leq 2.5$</td> <td>$0.05 < W \leq 0.075$</td> </tr> <tr> <td>---</td> <td>$W > 0.075$</td> <td colspan="2">As round type</td> </tr> </tbody> </table>	Dimension (diameter : Φ)	Acceptance (Q'ty)		A area	B area	$\Phi \leq 0.10$	Accept no dense		$0.10 < \Phi \leq 0.20$	3	Ignore	$0.20 < \Phi \leq 0.30$	2	Total quantity	4	Dimension		Acceptance (Q'ty)		Length (L)	Width (W)	A area	B area	---	$W \leq 0.03$	Accept no dense	Ignore	$L \leq 3.0$	$0.03 < W \leq 0.05$	4	$L \leq 2.5$	$0.05 < W \leq 0.075$	---	$W > 0.075$	As round type		Minor
Dimension (diameter : Φ)	Acceptance (Q'ty)																																						
	A area	B area																																					
$\Phi \leq 0.10$	Accept no dense																																						
$0.10 < \Phi \leq 0.20$	3	Ignore																																					
$0.20 < \Phi \leq 0.30$	2																																						
Total quantity	4																																						
Dimension		Acceptance (Q'ty)																																					
Length (L)	Width (W)	A area	B area																																				
---	$W \leq 0.03$	Accept no dense	Ignore																																				
$L \leq 3.0$	$0.03 < W \leq 0.05$	4																																					
$L \leq 2.5$	$0.05 < W \leq 0.075$																																						
---	$W > 0.075$	As round type																																					
06	Polarizer Bubble 	<table border="1" data-bbox="454 1523 1364 1948"> <thead> <tr> <th rowspan="2">Dimension (diameter : Φ)</th> <th colspan="2">Acceptance (Q'ty)</th> </tr> <tr> <th>A area</th> <th>B area</th> </tr> </thead> <tbody> <tr> <td>$\Phi \leq 0.20$</td> <td colspan="2">Accept no dense</td> </tr> <tr> <td>$0.20 < \Phi \leq 0.50$</td> <td>3</td> <td rowspan="4">Ignore</td> </tr> <tr> <td>$0.50 < \Phi \leq 1.00$</td> <td>2</td> </tr> <tr> <td>$\Phi > 1.00$</td> <td>0</td> </tr> <tr> <td>Total quantity</td> <td>4</td> </tr> </tbody> </table>	Dimension (diameter : Φ)	Acceptance (Q'ty)		A area	B area	$\Phi \leq 0.20$	Accept no dense		$0.20 < \Phi \leq 0.50$	3	Ignore	$0.50 < \Phi \leq 1.00$	2	$\Phi > 1.00$	0	Total quantity	4	Minor																			
Dimension (diameter : Φ)	Acceptance (Q'ty)																																						
	A area	B area																																					
$\Phi \leq 0.20$	Accept no dense																																						
$0.20 < \Phi \leq 0.50$	3	Ignore																																					
$0.50 < \Phi \leq 1.00$	2																																						
$\Phi > 1.00$	0																																						
Total quantity	4																																						

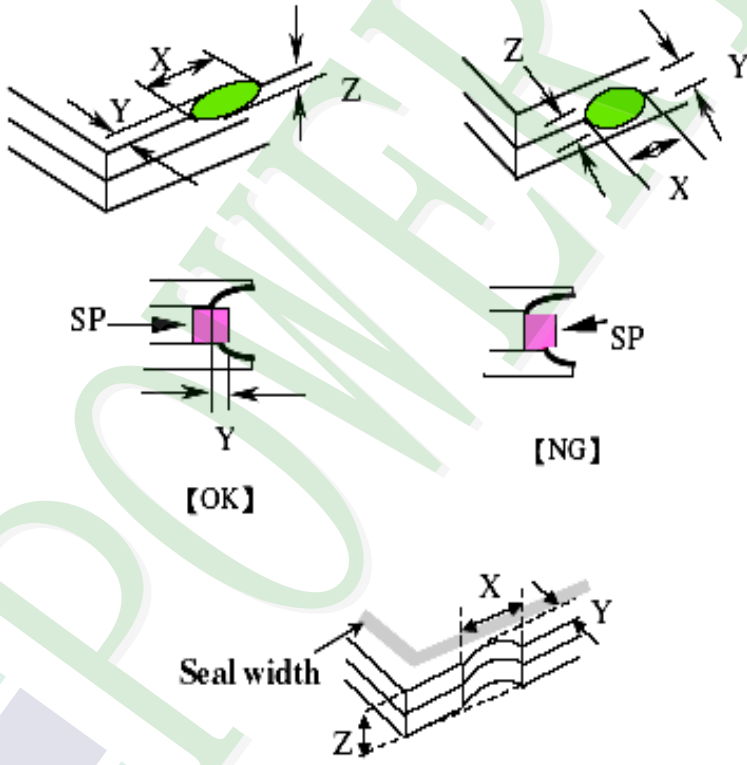
NO	Item	Criterion	Level						
07	The crack of glass	<p>Symbols :</p> <p>X : The length of crack Z : The thickness of crack t : The thickness of glass</p> <p>Y : The width of crack. W : terminal length a : LCD side length</p>	Minor						
		<p>7.1 General glass chip :</p> <p>7.1.1 Chip on panel surface and crack between panels:</p>  <table border="1" data-bbox="507 1630 1308 1948"> <thead> <tr> <th>X</th> <th>Y</th> <th>Z</th> </tr> </thead> <tbody> <tr> <td>$\leq a$</td> <td>Crack can't enter viewing area</td> <td>$\leq 1/2 t$</td> </tr> <tr> <td>$\leq a$</td> <td>Crack can't exceed the half of SP width.</td> <td>$1/2 t < Z \leq 2 t$</td> </tr> </tbody> </table>		X	Y	Z	$\leq a$	Crack can't enter viewing area	$\leq 1/2 t$
X	Y	Z							
$\leq a$	Crack can't enter viewing area	$\leq 1/2 t$							
$\leq a$	Crack can't exceed the half of SP width.	$1/2 t < Z \leq 2 t$							

◆ Specification For Monotype and Color STN :
(Ver. 03)

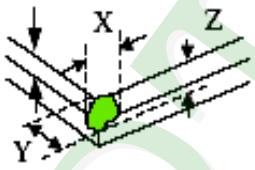
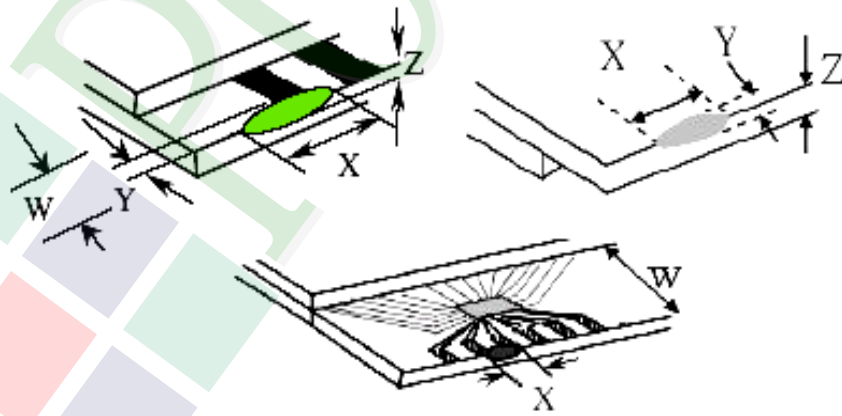
NO	Item	Criterion	Level									
07	The crack of glass	<p>Symbols :</p> <p>X : The length of crack Y : The width of crack. Z : The thickness of crack W : terminal length t : The thickness of glass a : LCD side length</p> <hr/> <p>7.1.2 Corner crack :</p>  <table border="1" data-bbox="512 855 1326 1171"> <thead> <tr> <th>X</th> <th>Y</th> <th>Z</th> </tr> </thead> <tbody> <tr> <td>$\leq 1/5 a$</td> <td>Crack can't enter viewing area</td> <td>$Z \leq 1/2 t$</td> </tr> <tr> <td>$\leq 1/5 a$</td> <td>Crack can't exceed the half of SP width.</td> <td>$1/2 t < Z \leq 2 t$</td> </tr> </tbody> </table>	X	Y	Z	$\leq 1/5 a$	Crack can't enter viewing area	$Z \leq 1/2 t$	$\leq 1/5 a$	Crack can't exceed the half of SP width.	$1/2 t < Z \leq 2 t$	Minor
		X	Y	Z								
$\leq 1/5 a$	Crack can't enter viewing area	$Z \leq 1/2 t$										
$\leq 1/5 a$	Crack can't exceed the half of SP width.	$1/2 t < Z \leq 2 t$										
<p>7.2 Protrusion over terminal :</p> <p>7.2.1 Chip on electrode pad :</p>  <table border="1" data-bbox="478 1798 1265 1984"> <thead> <tr> <th></th> <th>X</th> <th>Y</th> <th>Z</th> </tr> </thead> <tbody> <tr> <td>Front</td> <td>$\leq a$</td> <td>$\leq 1/2 W$</td> <td>$\leq t$</td> </tr> <tr> <td>Back</td> <td colspan="3">Neglect</td> </tr> </tbody> </table>		X	Y	Z	Front	$\leq a$	$\leq 1/2 W$	$\leq t$	Back	Neglect		
	X	Y	Z									
Front	$\leq a$	$\leq 1/2 W$	$\leq t$									
Back	Neglect											

◆ Specification For Monotype and Color STN :

(Ver. 03)

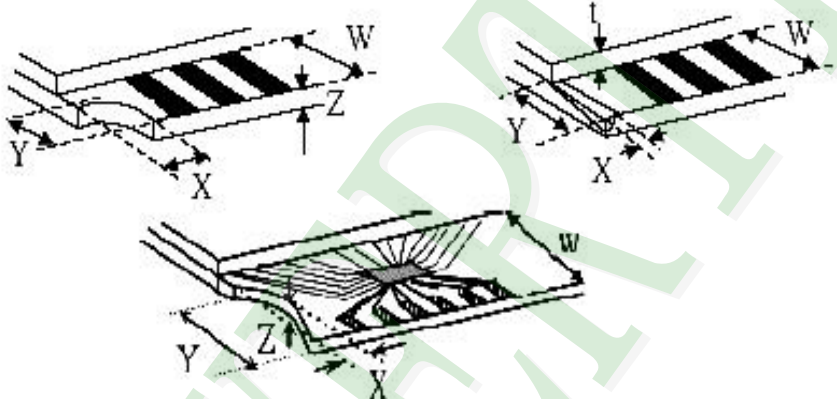
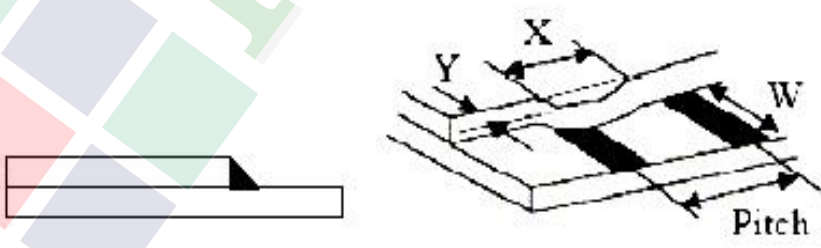
NO	Item	Criterion	Level									
07	The crack of glass	<p>Symbols :</p> <p>X : The length of crack Y : The width of crack. Z : The thickness of crack W : terminal length t : The thickness of glass a : LCD side length</p>	Minor									
		<p>7.2.2 Non-conductive portion :</p>  <table border="1" data-bbox="582 1108 1216 1276"> <thead> <tr> <th>X</th> <th>Y</th> <th>Z</th> </tr> </thead> <tbody> <tr> <td>$\leq 1/3 a$</td> <td>$\leq W$</td> <td>$\leq t$</td> </tr> </tbody> </table> <p>⊙ If the chipped area touches the ITO terminal, over 2/3 of the ITO must remain and be inspected according to electrode terminal specifications.</p> <p>7.2.3 Glass remain :</p>  <table border="1" data-bbox="502 1848 1197 2004"> <thead> <tr> <th>X</th> <th>Y</th> <th>Z</th> </tr> </thead> <tbody> <tr> <td>$\leq a$</td> <td>$\leq 1/3 W$</td> <td>$\leq t$</td> </tr> </tbody> </table>		X	Y	Z	$\leq 1/3 a$	$\leq W$	$\leq t$	X	Y	Z
X	Y	Z										
$\leq 1/3 a$	$\leq W$	$\leq t$										
X	Y	Z										
$\leq a$	$\leq 1/3 W$	$\leq t$										

◆Specification For Monotype and Color STN :
(Ver. 03)

NO	Item	Criterion	Level
08	Backlight elements	8. 1 Backlight can't work normally.	Major
		8. 2 Backlight doesn't light or color is wrong.	Major
		8. 3 Illumination source flickers when lit.	Major
09	General appearance	9. 1 Pin type must match type in specification sheet.	Major
		9. 2 No short circuits in components on PCB or FPC.	Major
		9. 3 Product packaging must the same as specified on packaging specification sheet.	Minor
		9. 4 The folding and peeled off in polarizer are not acceptable.	Minor
		9. 5 The PCB or FPC between B/L assembled distance (PCB or FPC) is ≤ 1.5 mm.	Minor

4. RELIABILITY TEST

Reliability Test Condition

NO.	TEST ITEM	TEST CONDITION	
1	High Temperature Storage Test	Keep in $80 \pm 2^{\circ}\text{C}$ 240 hrs Surrounding temperature, then storage at normal condition 4hrs.	
2	Low Temperature Storage Test	Keep in $-30 \pm 2^{\circ}\text{C}$ 240 hrs Surrounding temperature, then storage at normal condition 4hrs.	
3	High Temperature Operating Test	Keep in $70 \pm 2^{\circ}\text{C}$ 240 hrs Surrounding temperature, then storage at normal condition 24hrs.	
4	Low Temperature Operating Test	Keep in $-20 \pm 2^{\circ}\text{C}$ 240 hrs Surrounding temperature, then storage at normal condition 24hrs.	
5	High Temperature / High Humidity Storage Test & Operating Test	Keep in $+60^{\circ}\text{C}$ / 90% R.H duration for 240 hrs Surrounding temperature, then storage at normal condition 4hrs. (Excluding the polarizer)	
6	ESD Test	Air Discharge: Apply 2 KV with 5 times Discharge for each polarity +/-	Contact Discharge: Apply 250 V with 5 times discharge for each polarity +/-
		1. Temperature ambience : $15^{\circ}\text{C} \sim 35^{\circ}\text{C}$ 2. Humidity relative : 30% ~ 60% 3. Energy Storage Capacitance(Cs+Cd) : $150\text{pF} \pm 10\%$ 4. Discharge Resistance(Rd) : $330\Omega \pm 10\%$ 5. Discharge, mode of operation : Single Discharge (time between successive discharges at least 1 sec) (Tolerance if the output voltage indication : $\pm 5\%$)	
7	Temperature Cycling Operating Test	$-20^{\circ}\text{C} \rightarrow +25^{\circ}\text{C} \rightarrow +70^{\circ}\text{C} \rightarrow +25^{\circ}\text{C}$ (30mins) (5mins) (30mins) (5mins) ←————— 25 Cycle —————→ Surrounding temperature, then storage at normal condition 4hrs.	
8	Vibration Test (Packaged)	1. Sine wave 10~55 Hz frequency (1 min) 2. The amplitude of vibration : 1.5 mm 3. Each direction (X、Y、Z) duration for 2 Hrs	

9	Drop Test (Packaged)	Packing Weight (Kg)	Drop Height (cm)
		0 ~ 45.4	122
		45.4 ~ 90.8	76
		90.8 ~ 454	61
		Over 454	46
Drop direction : ※1 corner / 3 edges / 6 sides each 1times			



5. PRECAUTION RELATING PRODUCT HANDLING

5.1 SAFETY

- 5.1.1 If the LCD panel breaks , be careful not to get the liquid crystal to touch your skin.
- 5.1.2 If the liquid crystal touches your skin or clothes , please wash it off immediately by using soap and water.

5.2 HANDLING

- 5.2.1 Avoid any strong mechanical shock which can break the glass.
- 5.2.2 Avoid static electricity which can damage the CMOS LSI—When working with the module , be sure to ground your body and any electrical equipment you may be using.
- 5.2.3 Do not remove the panel or frame from the module.
- 5.2.4 The polarizing plate of the display is very fragile. So , please handle it very carefully ,do not touch , push or rub the exposed polarizing with anything harder than an HB pencil lead (glass , tweezers , etc.)
- 5.2.5 Do not wipe the polarizing plate with a dry cloth , as it may easily scratch the surface of plate.
- 5.2.6 Do not touch the display area with bare hands , this will stain the display area.
- 5.2.7 Do not use ketonics solvent & aromatic solvent. Use with a soft cloth soaked with a cleaning naphtha solvent.
- 5.2.8 To control temperature and time of soldering is $320\pm 10^{\circ}\text{C}$ and 3-5 sec.
- 5.2.9 To avoid liquid (include organic solvent) stained on LCM .

5.3 STORAGE

- 5.3.1 Store the panel or module in a dark place where the temperature is $25^{\circ}\text{C} \pm 5^{\circ}\text{C}$ and the humidity is below 65% RH.
- 5.3.2 Do not place the module near organics solvents or corrosive gases.
- 5.3.3 Do not crush , shake , or jolt the module.

5.4 TERMS OF WARRANTY

- 5.4.1 Applicable warrant period
The period is within thirteen months since the date of shipping out under normal using and storage conditions.
- 5.4.2 Unaccepted responsibility
This product has been manufactured to your company's specification as a part for use in your company's general electronic products. It is guaranteed to perform according to delivery specifications. For any other use apart from general electronic equipment , we cannot take responsibility if the product is used in nuclear power control equipment , aerospace equipment , fire and security systems or any other applications in which there is a direct risk to human life and where extremely high levels of reliability are required.

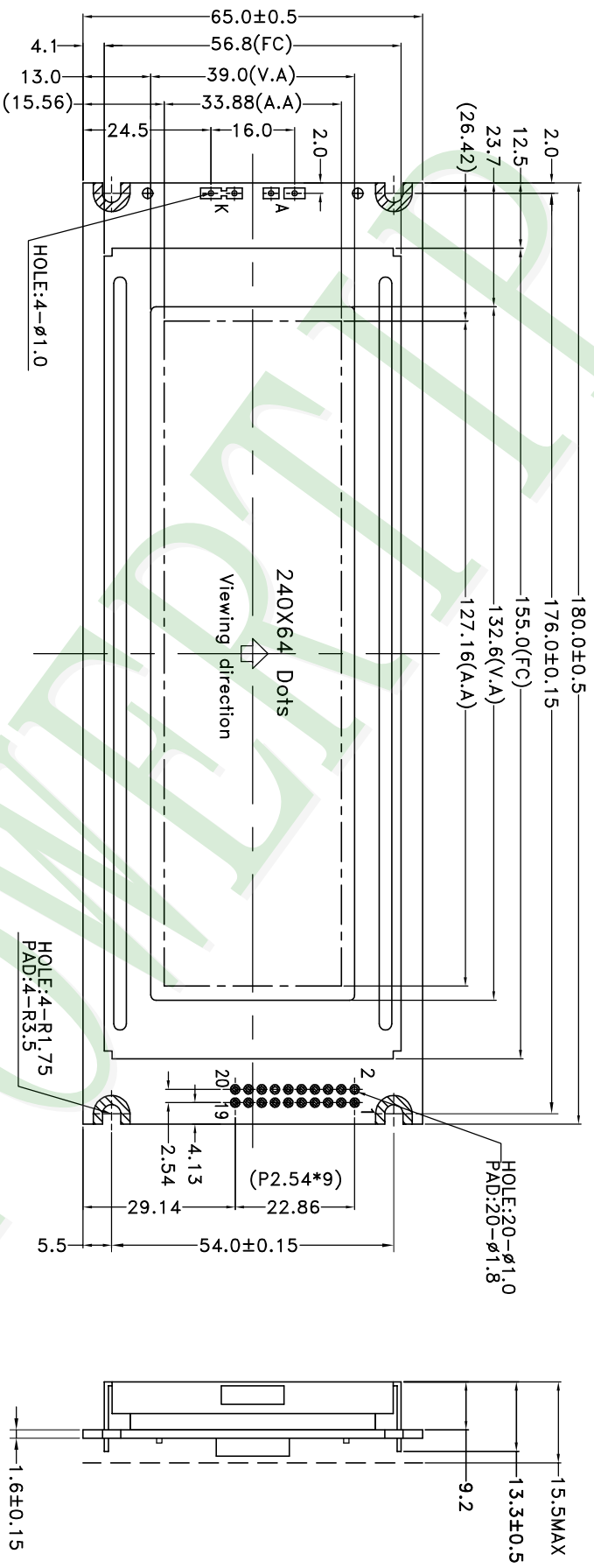

- NOTE:
1. LCD TYPE: White,STN,Transflective,Positive.
 2. LCD Module: 1/64duty, 1/9bias.
 3. Viewing Direction: 6 O'clock.
 4. Top: -20 TO 70°C, Tst: -30 TO 80°C.
 5. The tolerance unless classified: ±0.3mm
 6. This product conforms ROHS.

SCALE:15/1

007	PART NO.:	PG24064WRF-EGAH16Q	Design	AI Xue Fang	Huang Ji e Fang	Unit	MM	Surface		精度	
006	DRAWING NAME:	HLM-D-PG24064WRF-EGAH16Q	Check	Li Zhong		Scale	1:1	Material		精度	
005	TITLE:	LCD Module Drawing	Approve	Cai Zhi Chuan		Page	1/1	Thickness		精度	
004								Quantity		精度	
003										精度	
002										精度	
001										精度	
REV	NEW DRAWING	REV BY	REVISER	DATE							

久正光電股份有限公司
POWER TIP TECHNOLOGY CORPORATION



本公司精製
LCD 液晶模組
精度

Ver.002

Documents NO. JPKG-PG24064WRF-EGAH16Q

LCM包裝規格書

LCM Packaging Specifications

Approve

Check

Contact

Ryan

Terry

Air

1. 包裝材料規格表 (Packaging Material) : (per carton)

No.	Item	Model	Dimensions (mm)	1Pcs Weight	Quantity	Total Weight
1	成品(LCM)	PG24064WRF-EGAH16Q	180 X 65 X 15.5	0.1694	48	8.1312
2	靜電袋(1)Antistatic Bag	BAG250100ARABA	250 X 100 X 0.05	0.0024	48	0.1152
3	氣泡袋(2)Bubble Bag	BAG200160BRABA	200 X 160	0.0096	48	0.4608
4	氣泡墊(3)Bubble Bag	BAG290240BRBBA	240 X 290 X 5	0.0029	16	0.0464
5	刀卡A2(4)BX	BX29500072BZBA	295 X 72 X 3	0.011	56	0.616
6	刀卡B2(5)BX	BX24500072BZBA	245 X 72 X 3	0.01	32	0.32
7	C2內盒(6)Product Box	BX31025580AABA	310 X 255 X 86	0.16	8	1.28
8	外紙箱(7)Carton	BX52532536CCBA	525 X 325 X 360	0.83	1	0.83
9						

2. 一整箱總重量 (Total LCD Weight in carton) : 11.80 Kg±10%

3. 單箱數量規格表 (Packaging Specifications and Quantity) :

(1)Quantity Of Spacer : A2刀卡 X 7 , B2刀卡 X 4

(2)Total LCM quantity in carton : quantity per box 6 x no. of boxes 8 = 48

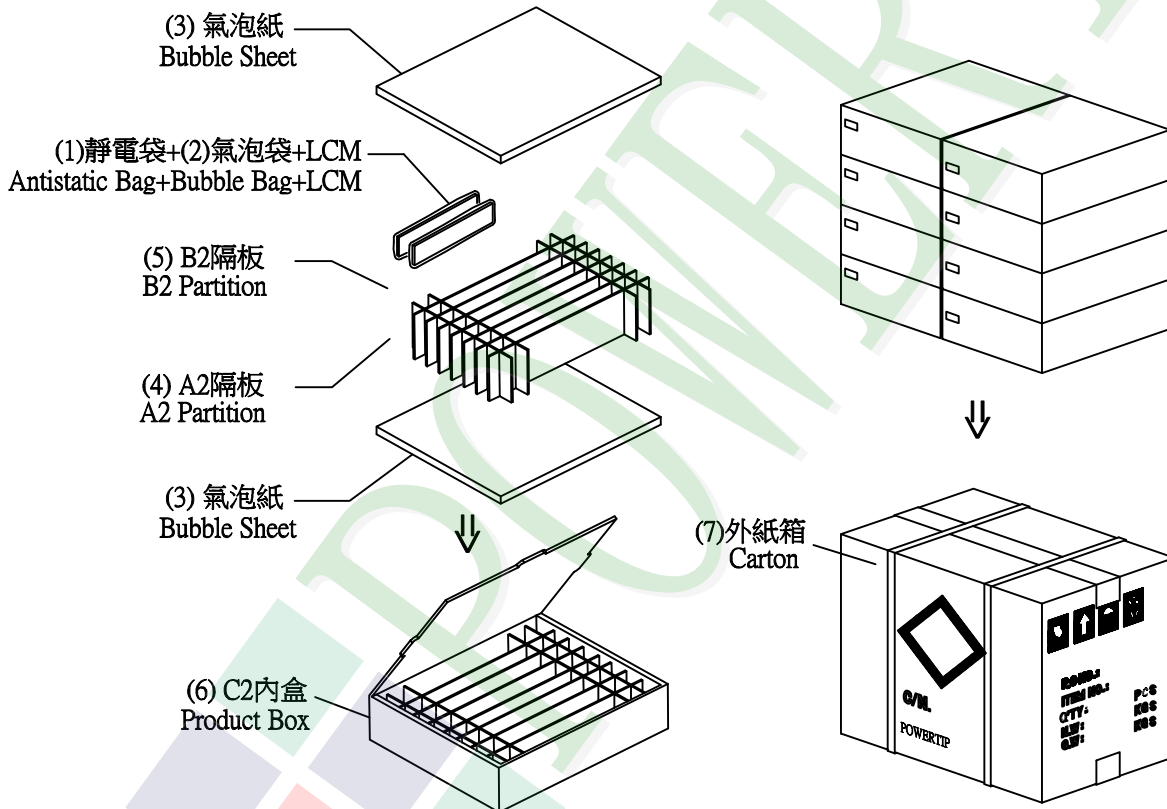

特 記 事 項 (REMARK)

4. Label Specifications :

標籤依廠內標準作業

5. LCM排放示意圖(前後間隔不放置):

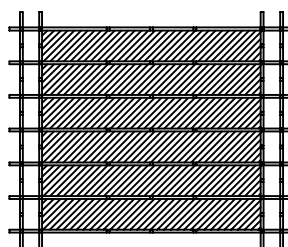
5. LCM placed as figure showing:
(First and last slot should be empty)

▨ 模組(LCM) X 1pcs.