

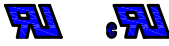



# 宁波洋光欧利电器有限公司

NINGBO YANG GUANG AULI ELECTRONICS APPLIANCE CO., LTD.

<ul style="list-style-type: none"> <li>* Product Name: Rocker Switch;</li> <li>* Model No: YSR-14 (B)</li> <li>* Voltage Resistance: 2000VAC, 1MIN;</li> <li>* Operating Temperature: T85</li> <li>* Electrical Life: more than 10,000cycles</li> <li>* Contact Rating: UL CUL: 3/6A 250/125VAC, 5/10A 250/125VAC</li> </ul>			
KNOB COLOR	BLACK; RED; GREEN; ORANGE; BLUE; ...		
BASE COLOR	GRAY; BLACK; WHITE; ...		
KNOB SHAPE	TYPE C: 	Unilluminate	YSR-14-12 (B) 1P2T 3P
Illuminate	YSR-14-11 (B) /N 1P1T 3P		YSR-14-11 (B) 1P1T 2P

## Wiring Diagram

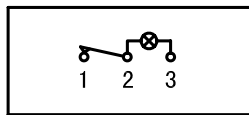

YSR-14-11 (B) /N  
On-Off (Illuminate)

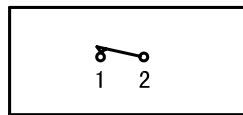

YSR-14-11 (B)  
On-Off (Unilluminate)

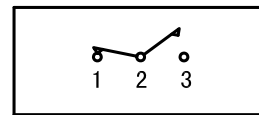

YSR-14-12 (B)  
On-On (Unilluminate)

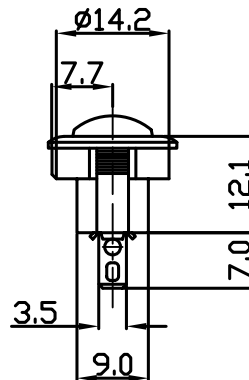
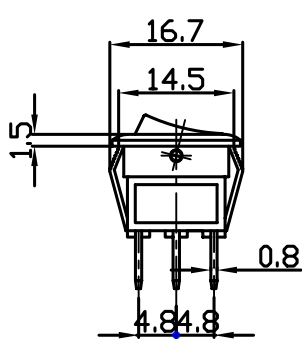

## Panel Installation Size

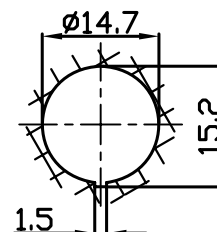
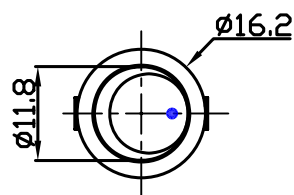

Panel Installation  
Thickness 1 ~ 4mm