

General Description

The LM2575 series of monolithic integrated circuits provide all the active functions for a step-down (buck) switching regulator. Fixed versions are available with a 3.3V, 5V, 12V, fixed output. Adjustable versions have an output voltage range from 1.23V to 37V. Both versions are capable of driving a 1A load with excellent line and load regulation.

These regulators are simple to use because they require a minimum number of external components and include internal frequency compensation and a fixed-frequency oscillator.

The LM2575 series offers a high efficiency replacement for popular three-terminal adjustable linear regulators. It substantially reduces the size of the heat sink, and in many cases no heat sink is required.

A standard series of inductors available from several different manufacturers are ideal for use with the LM2575 series. This feature greatly simplifies the design of switch-mode power supplies.

The feedback voltage is guaranteed to $\pm 2\%$ tolerance for adjustable versions, and the output voltage is guaranteed to $\pm 3\%$ for fixed versions, within specified input voltages and output load conditions. The oscillator frequency is guaranteed to $\pm 10\%$. External shutdown is included, featuring less than 200 μ A standby current. The output switch includes cycle-by-cycle current limiting and thermal shutdown for full protection under fault conditions.

Features

- 3.3V, 5V, 12V, and adjustable output versions
- Voltage over specified line and load conditions:
Fixed version: $\pm 3\%$ max. output voltage
Adjustable version: $\pm 2\%$ max. feedback voltage
- Guaranteed 1A output current
- Wide input voltage range:
4V to 40V
- Wide output voltage range
1.23V to 37V
- Requires only 4 external components
- 52kHz fixed frequency internal oscillator
- Low power standby mode I_Q typically < 200 μ A
- 80% efficiency (adjustable version typically > 80%)
- Uses readily available standard inductors
- Thermal shutdown and current limit protection
- 100% electrical thermal limit burn-in

Applications

- Simple high-efficiency step-down (buck) regulator
- Efficient pre-regulator for linear regulators
- On-card switching regulators
- Positive to negative converter (inverting Buck-Boost)
- Isolated Flyback Converter using minimum number of external components
- Negative Boost Converter

Typical Applications

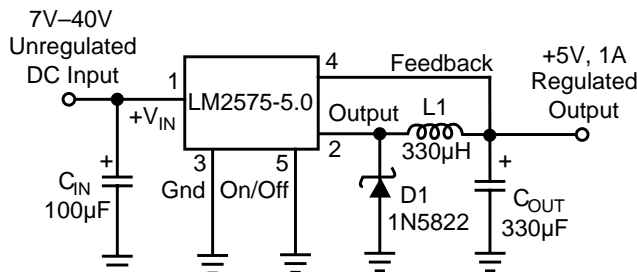

Note: Pin numbers are for TO-220 Package

Fixed Regulator in Typical Application

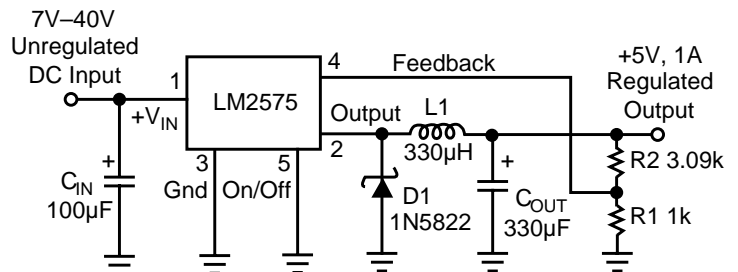

Note: Pin numbers are for TO-220 Package

$$V_{OUT} = 1.23 \left(1 + \frac{R2}{R1} \right)$$

Adjustable Regulator in Fixed Output Application

Ordering Information

| Part Number [‡] | Temperature Range | Package |
|---------------------------|-------------------|--------------------|
| LM2575BN* | -40°C to +85 °C | 16-pin Plastic DIP |
| LM2575-3.3BN | -40°C to +85 °C | 16-pin Plastic DIP |
| LM2575-5.0BN | -40°C to +85 °C | 16-pin Plastic DIP |
| LM2575-12BN | -40°C to +85 °C | 16-pin Plastic DIP |
| LM2575BWM* | -40°C to +85°C | 24-pin Wide SOIC |
| LM2575-3.3BWM | -40°C to +85°C | 24-pin Wide SOIC |
| LM2575-5.0BWM | -40°C to +85°C | 24-pin Wide SOIC |
| LM2575-12BWM | -40°C to +85°C | 24-pin Wide SOIC |
| LM2575BT* [†] | -40°C to +85°C | 5-lead TO-220 |
| LM2575-3.3BT [†] | -40°C to +85°C | 5-lead TO-220 |
| LM2575-5.0BT [†] | -40°C to +85°C | 5-lead TO-220 |
| LM2575-12BT [†] | -40°C to +85°C | 5-lead TO-220 |
| LM2575BU* | -40°C to +85°C | 5-lead TO-263 |
| LM2575-3.3BU | -40°C to +85°C | 5-lead TO-263 |
| LM2575-5.0BU | -40°C to +85°C | 5-lead TO-263 |
| LM2575-12BU | -40°C to +85°C | 5-lead TO-263 |

* Adjustable output regulators.

[†] Contact factory for bent or staggered leads option.

Pin Configurations

5-LEAD TO-220 (T)

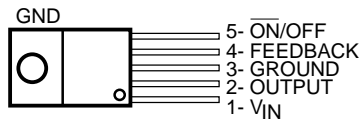

5-LEAD TO-263 (U)

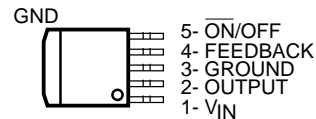

16-LEAD DIP (N)

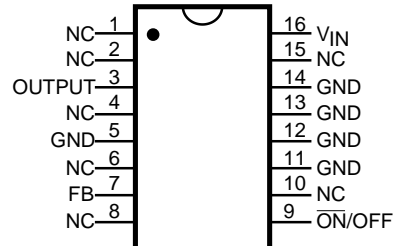

24-LEAD SOIC (WM)

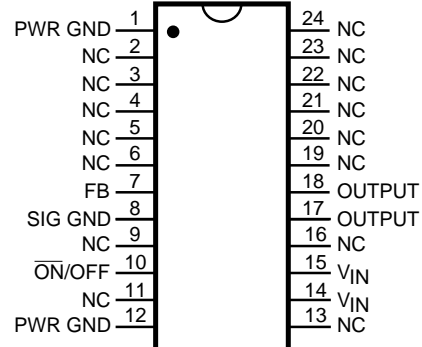

Absolute Maximum Ratings (Note 1)

| | |
|---|---|
| Maximum Supply Voltage | 45V |
| ON/OFF Pin Input Voltage | $-0.3V \leq V \leq +40V$ |
| Output Voltage to Ground (Steady State) | -1V |
| Power Dissipation | Internally Limited |
| Storage Temperature Range | -65°C to $+150^{\circ}\text{C}$ |
| Minimum ESD Rating | |
| C = 100pF, R = 1.5k Ω | 2 kV |
| FB Pin | 1 kV |
| Lead Temperature (soldering, 10 sec.) | 260 $^{\circ}\text{C}$ |
| Maximum Junction Temperature | 150 $^{\circ}\text{C}$ |

Operating Ratings

| | |
|-------------------|--|
| Temperature Range | $-40^{\circ}\text{C} \leq T_J \leq +125^{\circ}\text{C}$ |
| Supply Voltage | 40V |

Electrical Characteristics Specifications with standard typeface are for $T_J = 25^{\circ}\text{C}$, and those with **boldface type** apply over **full Operating Temperature Range**. Unless otherwise specified, $V_{IN} = 12\text{V}$, and $I_{LOAD} = 200\text{mA}$.

| Symbol | Parameter | Conditions | Typ | LM2575 | |
|---|------------------------------|---|-------|--|-----------------------|
| | | | | Limit (Note 2) | Units (Limits) |
| SYSTEM PARAMETERS, ADJUSTABLE REGULATORS (Note 3) Test Circuit <i>Figure 1</i> | | | | | |
| V_{OUT} | Feedback Voltage | $V_{IN} = 12\text{V}$, $I_{LOAD} = 0.2\text{A}$ $V_{OUT} = 5\text{V}$ | 1.230 | 1.217 1.243 | V V(min) V(max) |
| V_{OUT} | Feedback Voltage LM2575 | $0.2\text{A} \leq I_{LOAD} \leq 1\text{A}$, $8\text{V} \leq V_{IN} \leq 40\text{V}$ $V_{OUT} = 5\text{V}$ | 1.230 | 1.193/ 1.180 1.267/ 1.280 | V V(min) V(max) |
| η | Efficiency | $V_{IN} = 12\text{V}$, $I_{LOAD} = 1\text{A}$, $V_{OUT} = 5\text{V}$ | 82 | | % |
| SYSTEM PARAMETERS, 3.3V REGULATORS (Note 3) Test Circuit <i>Figure 1</i> | | | | | |
| V_{OUT} | Output Voltage | $V_{IN} = 12\text{V}$, $I_{LOAD} = 0.2\text{A}$ $V_{OUT} = 3.3\text{V}$ | 3.3 | 3.234 3.366 | V V(min) V(max) |
| V_{OUT} | Output Voltage LM2575-3.3 | $0.2\text{A} \leq I_{LOAD} \leq 1\text{A}$, $8\text{V} \leq V_{IN} \leq 40\text{V}$ $V_{OUT} = 3.3\text{V}$ | 3.3 | 3.168/ 3.135 3.432/ 3.465 | V V(min) V(max) |
| η | Efficiency | $V_{IN} = 12\text{V}$, $I_{LOAD} = 1\text{A}$ | 75 | | % |
| SYSTEM PARAMETERS, 5V REGULATORS (Note 3) Test Circuit <i>Figure 1</i> | | | | | |
| V_{OUT} | Output Voltage | $V_{IN} = 12\text{V}$, $I_{LOAD} = 0.2\text{A}$ $V_{OUT} = 5\text{V}$ | 5.0 | 4.900 5.100 | V V(min) V(max) |
| V_{OUT} | Output Voltage LM2575-5.0 | $0.2\text{A} \leq I_{LOAD} \leq 1\text{A}$, $8\text{V} \leq V_{IN} \leq 40\text{V}$ $V_{OUT} = 5\text{V}$ | 5.0 | 4.800/ 4.750 5.200/ 5.250 | V V(min) V(max) |
| η | Efficiency | $V_{IN} = 12\text{V}$, $I_{LOAD} = 1\text{A}$ | 82 | | % |
| SYSTEM PARAMETERS, 12V REGULATORS (Note 3) Test Circuit <i>Figure 1</i> | | | | | |
| V_{OUT} | Output Voltage | $V_{IN} = 25\text{V}$, $I_{LOAD} = 0.2\text{A}$ $V_{OUT} = 12\text{V}$ | 12 | 11.760 12.240 | V V(min) V(max) |
| V_{OUT} | Output Voltage LM2575-12 | $0.2\text{A} \leq I_{LOAD} \leq 1\text{A}$, $15\text{V} \leq V_{IN} \leq 40\text{V}$ $V_{OUT} = 12\text{V}$ | 12 | 11.520/ 11.400 12.480/ 12.600 | V V(min) V(max) |
| η | Efficiency | $V_{IN} = 25\text{V}$, $I_{LOAD} = 1\text{A}$ | 88 | | % |

Electrical Characteristics (continued)

| Symbol | Parameter | Conditions | Typ | LM2575 | Units (Limits) |
|---|---------------------------|---|----------------------------|--------------------|-------------------------------|
| | | | | Limit (Note 2) | |
| DEVICE PARAMETERS, ADJUSTABLE REGULATOR | | | | | |
| I_B | Feedback Bias Current | $V_{OUT} = 5V$ | 50 | 100/500 | nA |
| DEVICE PARAMETERS, FIXED and ADJUSTABLE REGULATORS | | | | | |
| f_O | Oscillator Frequency | | 52 | 47/42 58/63 | kHz kHz (min) kHz (max) |
| V_{SAT} | Saturation Voltage | $I_{OUT} = 1A$ (Note 4) | 0.9 | 1.2/1.4 | V V(max) |
| DC | Max Duty Cycle (ON) | (Note 5) | 98 | 93 | % %(min) |
| I_{CL} | Current Limit | Peak Current, $t_{ON} \leq 3\mu s$ (Note 4) | 2.2 | 1.7/1.3 3.0/3.2 | A A(min) A(max) |
| I_L | Output Leakage Current | $V_{IN} = 40V$, (Note 6), (Note 6) | 7.5 | 2 30 | mA(max) mA mA(max) |
| I_Q | Quiescent Current | (Note 6) | 5 | 10 | mA mA(max) |
| I_{STBY} | Standby Quiescent Current | ON/OFF Pin = 5V (OFF) | 50 | 200 | μA μA (max) |
| θ_{JA} θ_{JA} θ_{JC} θ_{JA} θ_{JA} | Thermal Resistance | T Package, Junction to Ambient (Note 7) T Package, Junction to Ambient (Note 8) T Package, Junction to Case N Package, Junction to Ambient (Note 9) WM Package, Junction to Amb. (Note 9) | 65 45 2 85 100 | | $^{\circ}C/W$ |

| Symbol | Parameter | Conditions | Typ | LM2575 | Units (Limits) |
|---|---------------------------------|----------------------------------|------------|------------------------------------|-------------------------|
| | | | | Limit (Note 2) | |
| ON/OFF CONTROL, FIXED and ADJUSTABLE REGULATORS Test Circuit <i>Figure 1</i> | | | | | |
| V_{IH} V_{IL} | ON/OFF Pin Logic Input Level | $V_{OUT} = 0V$ $V_{OUT} = 5V$ | 1.4 1.2 | 2.2/ 2.4 1.0/ 0.8 | V(min) V(max) |
| I_{IH} | ON /OFF Pin Logic Current | ON /OFF Pin = 5V (OFF) | 4 | 30 | μA $\mu A(max)$ |
| I_{IL} | | ON/OFF Pin = 0V (ON) | 0.01 | 10 | μA $\mu A(max)$ |

- Note 1:** Absolute Maximum Rating indicate limits beyond which damage to the device may occur. Operating Ratings indicate conditions for which the device is intended to be functional, but do not guarantee specific performance limits. For guaranteed specifications and test conditions, see the Electrical Characteristics.
- Note 2:** All limits guaranteed at room temperature (standard type face) and at **temperature extremes (bold type face)** . All room temperature limits are 100% production tested. All limits at **temperature extreme** are guaranteed via testing.
- Note 3:** External components such as the catch diode, inductor, input and output capacitors can affect switching regulator system performance. When the LM2575/LM1575 is used as shown in *Figure 1* test circuit, system performance will be shown in system parameters section of Electrical Characteristics.
- Note 4:** Output (pin 2) sourcing current. No diode, inductor or capacitor connected to output.
- Note 5:** Feedback (pin 4) removed from output and connected to 0V.
- Note 6:** Feedback (pin 4) removed from output and connected to 12V to force the output transistor OFF.
- Note 7:** Junction to ambient thermal resistance (no external heat sink) for the 5-lead TO-220 package mounted vertically, with 1/2" leads in a socket, or on PC board with minimum copper area.
- Note 8:** Junction to ambient thermal resistance (no external heat sink) for the 5-lead TO-220 package mounted vertically, with 1/4" leads soldered to PC board containing approximately 4 square inches of copper area surrounding the leads.
- Note 9:** Junction to ambient thermal resistance with approximately 1 square inch of pc board copper surrounding the leads. Additional copper will lower thermal resistance further.

Typical Performance Characteristics

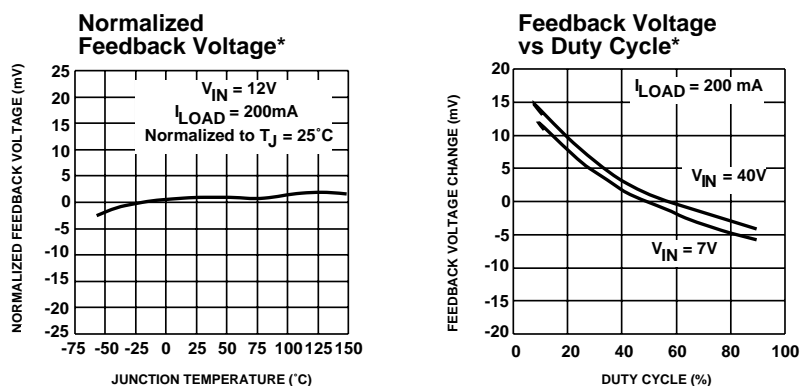

* Adjustable version only

Typical Performance Characteristics (continued) (Circuit of Figure 1)

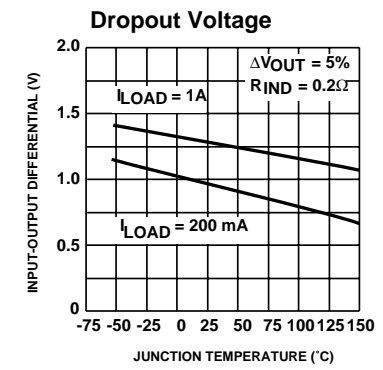
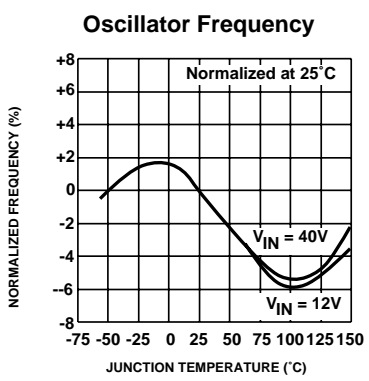
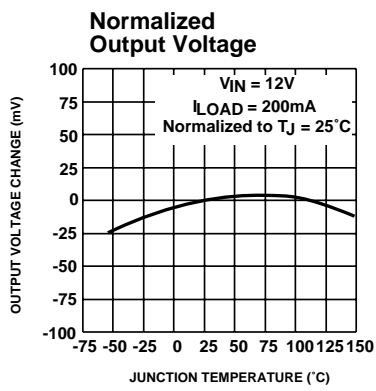
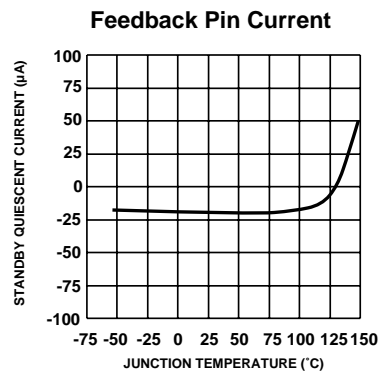
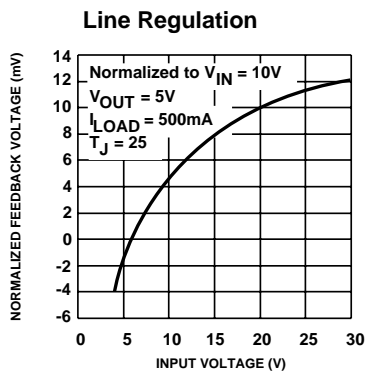
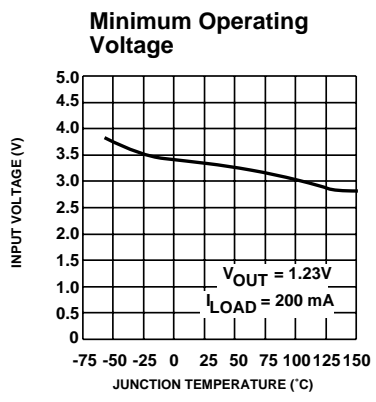
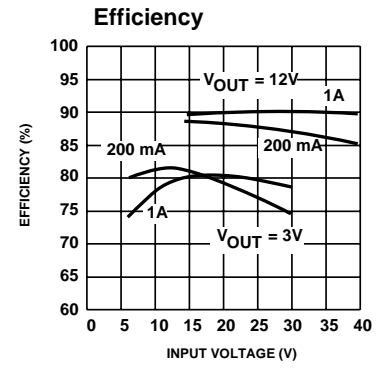
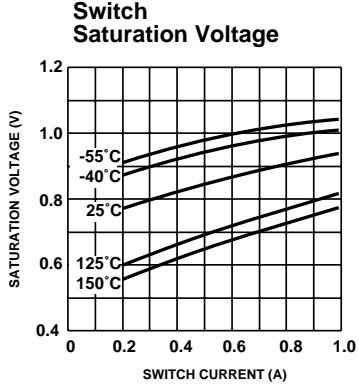
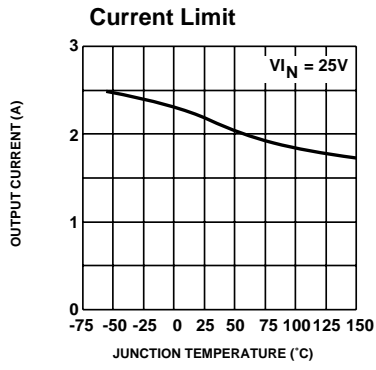
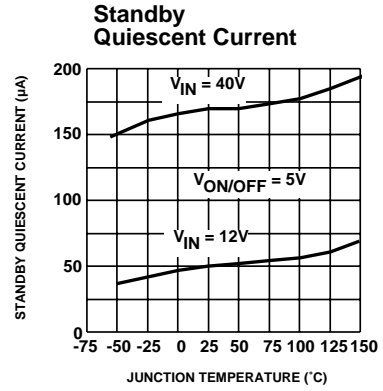
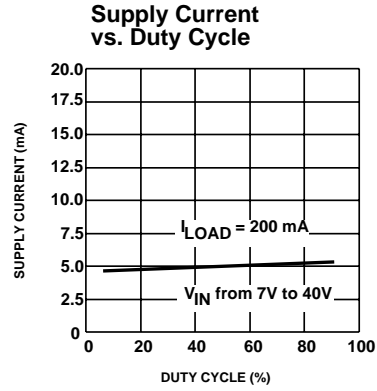
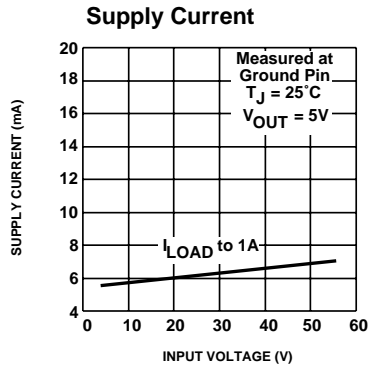

Typical Performance Characteristics (Circuit of Figure 1)

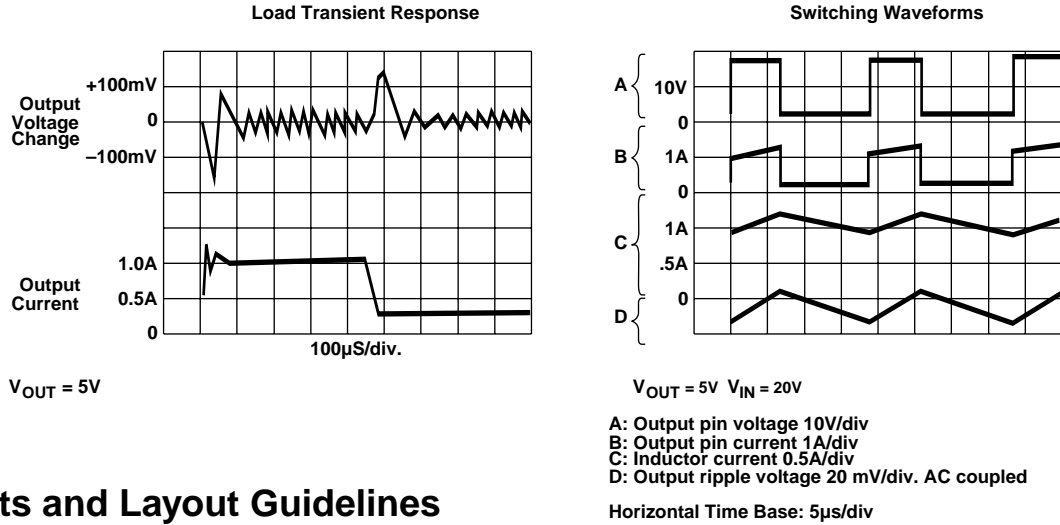

Test Circuits and Layout Guidelines

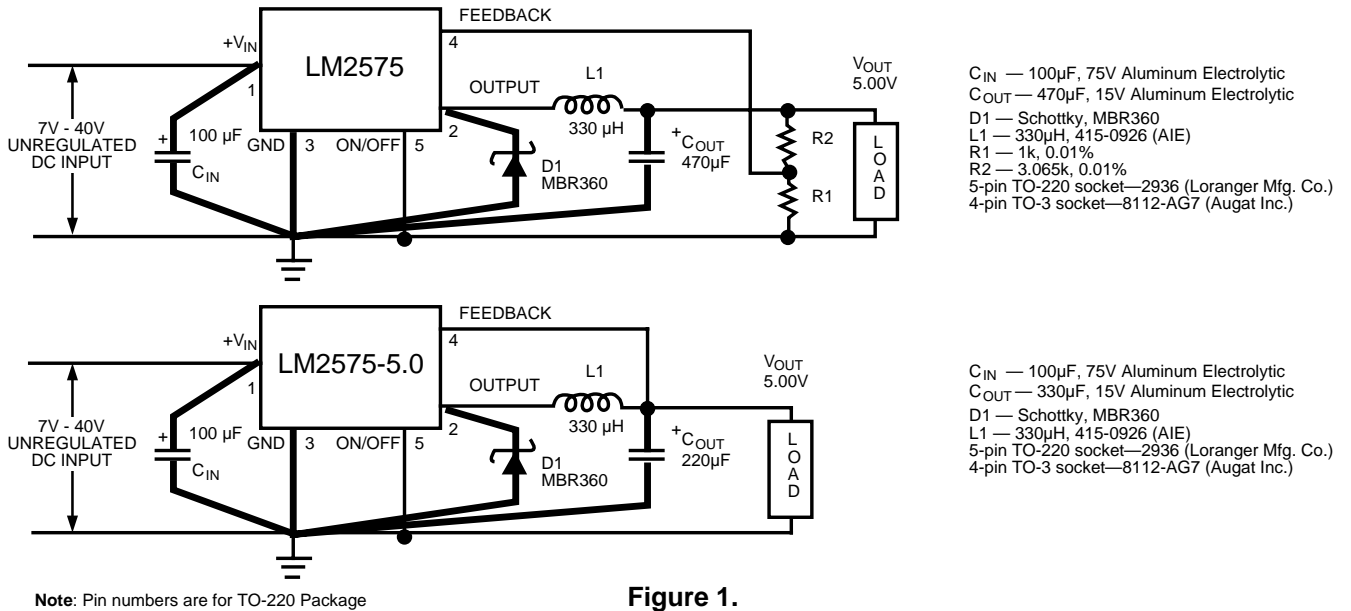

Figure 1.

As in any switching regulator, layout is very important. Rapidly switching currents associated with wiring inductance generate voltage transients which can cause problems. For minimal stray inductance and ground loops, the length of the leads indicated by heavy lines should be kept as short as possible. Single-point grounding (as indicated) or ground plane construction should be used for best results.

Block Diagrams

