

SWITCHING APPLICATION.
INTERFACE CIRCUIT AND DRIVER CIRCUIT APPLICATION.

FEATURES

- With Built-in Bias Resistors.
- Simplify Circuit Design.
- Reduce a Quantity of Parts and Manufacturing Process.

EQUIVALENT CIRCUIT

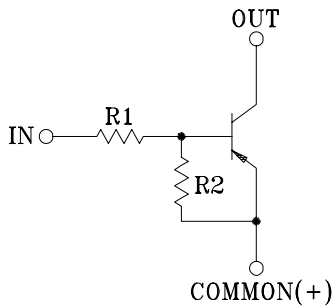

BIAS RESISTOR VALUES

TYPE NO.	R1(k Ω)	R2(k Ω)
KRA101M	4.7	4.7
KRA102M	10	10
KRA103M	22	22
KRA104M	47	47
KRA105M	2.2	47
KRA106M	4.7	47

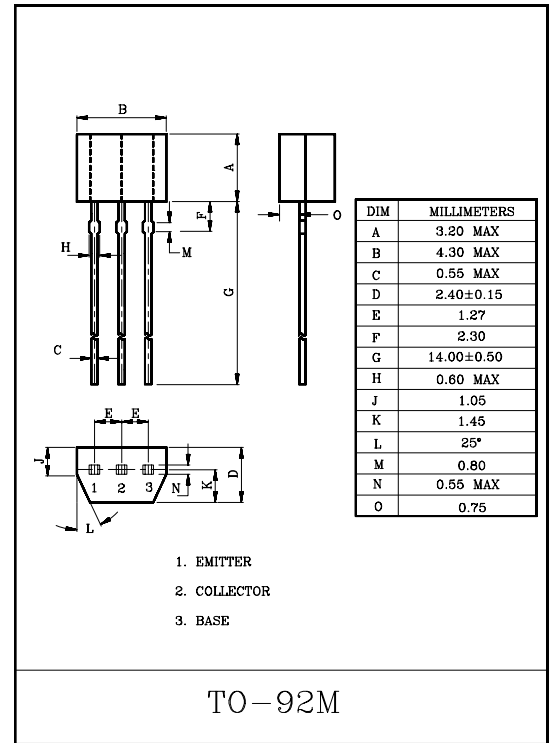

MAXIMUM RATINGS (Ta=25°C)

CHARACTERISTIC		SYMBOL	RATING	UNIT
Output Voltage	KRA101M ~106M	V _o	-50	V
Input Voltage	KRA101M	V _i	-20, 10	V
	KRA102M		-30, 10	
	KRA103M		-40, 10	
	KRA104M		-40, 10	
	KRA105M		-12, 5	
	KRA106M		-20, 5	
Output Current	KRA101M ~106M	I _o	-100	mA
Power Dissipation		P _D	400	mW
Junction Temperature		T _j	150	°C
Storage Temperature Range		T _{stg}	-55~150	°C

KRA101M~KRA106M

ELECTRICAL CHARACTERISTICS (Ta=25°C)

CHARACTERISTIC		SYMBOL	TEST CONDITION	MIN.	TYP.	MAX.	UNIT
Output Cut-off Current	KRA101M~106M	$I_{O(OFF)}$	$V_O=-50V, V_I=0$	-	-	-500	nA
DC Current Gain	KRA101M	G_I	$V_O=-5V, I_O=-10mA$	30	55	-	
	KRA102M			50	80	-	
	KRA103M			70	120	-	
	KRA104M			80	200	-	
	KRA105M			80	200	-	
	KRA106M			80	200	-	
Output Voltage	KRA101M~106M	$V_{O(ON)}$	$I_O=-10mA, I_I=-0.5mA$	-	-0.1	-0.3	V
Input Voltage (ON)	KRA101M	$V_{I(ON)}$	$V_O=-0.2V, I_O=-5mA$	-	-1.5	-2.0	V
	KRA102M			-	-1.8	-2.4	
	KRA103M			-	-2.1	-3.0	
	KRA104M			-	-2.8	-5.0	
	KRA105M			-	-0.8	-1.1	
	KRA106M			-	-0.9	-1.3	
Input Voltage (OFF)	KRA101M~104M	$V_{I(OFF)}$	$V_O=-5V, I_O=-0.1mA$	-1.0	-1.2	-	V
	KRA105M~106M			-0.5	-0.65	-	
Transition Frequency	KRA101M~106M	$f_T *$	$V_O=-10V, I_O=-5mA$	-	200	-	MHz
Input Current	KRA101M	I_I	$V_I=-5V$	-	-	-1.8	mA
	KRA102M			-	-	-0.88	
	KRA103M			-	-	-0.36	
	KRA104M			-	-	-0.18	
	KRA105M			-	-	-3.6	
	KRA106M			-	-	-1.8	

Note : *Characteristic of Transistor Only

KRA101M~KRA106M

ELECTRICAL CHARACTERISTICS (Ta=25°C)

CHARACTERISTIC		SYMBOL	TEST CONDITION	MIN.	TYP.	MAX.	UNIT	
Switching Time	Rise Time	KRA101M	$V_O=-5V$ $V_{IN}=-5V$ $R_L=1k\Omega$	-	0.07	-	μS	
		KRA102M		-	0.06	-		
		KRA103M		-	0.2	-		
		KRA104M		-	0.24	-		
		KRA105M		-	0.02	-		
		KRA106M		-	0.07	-		
	Storage Time	KRA101M		t_{stg}	-	1.1		-
		KRA102M		-	1.1	-		
		KRA103M		-	1.1	-		
		KRA104M		-	1.1	-		
		KRA105M		-	1.1	-		
		KRA106M		-	1.1	-		
	Fall Time	KRA101M		t_f	-	0.15		-
		KRA102M		-	0.24	-		
		KRA103M		-	0.38	-		
		KRA104M		-	0.63	-		
		KRA105M		-	0.1	-		
		KRA106M		-	0.2	-		

KRA101M~KRA106M

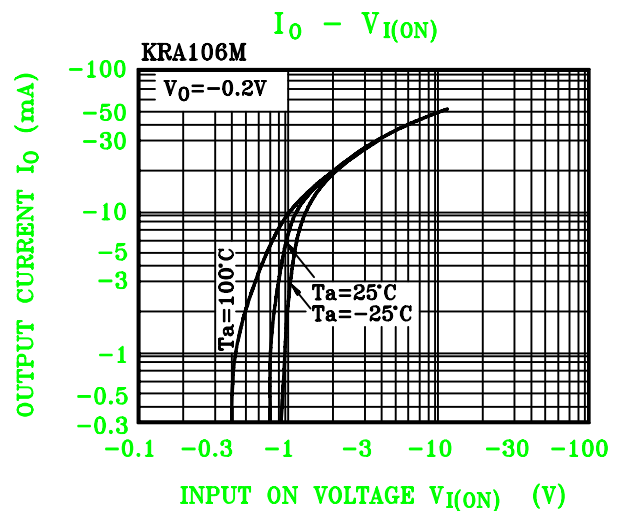
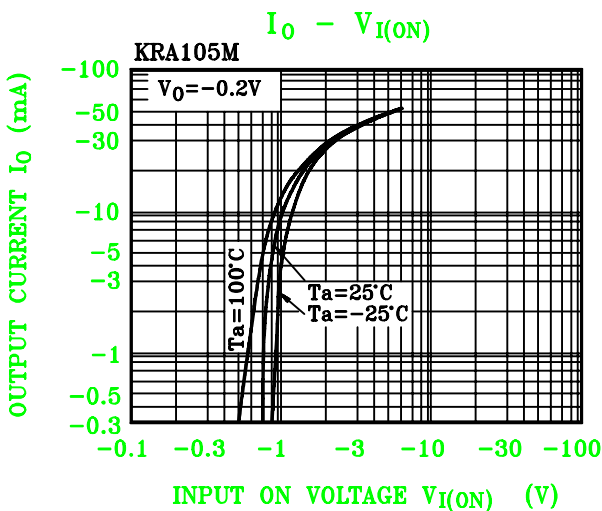
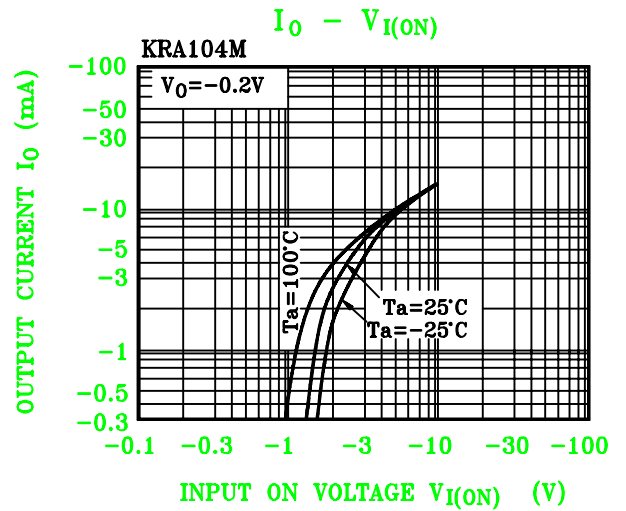
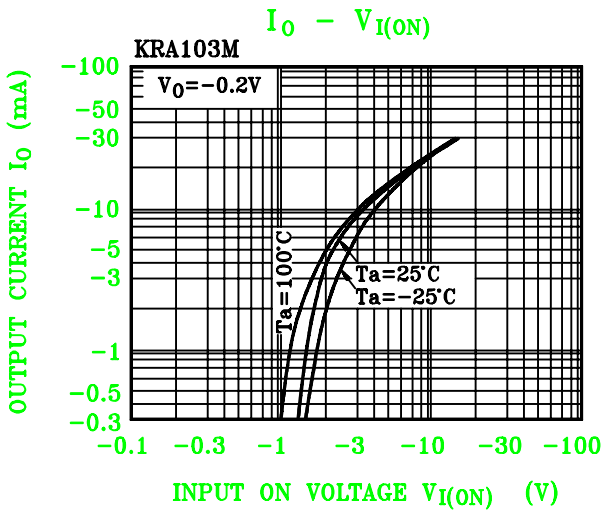
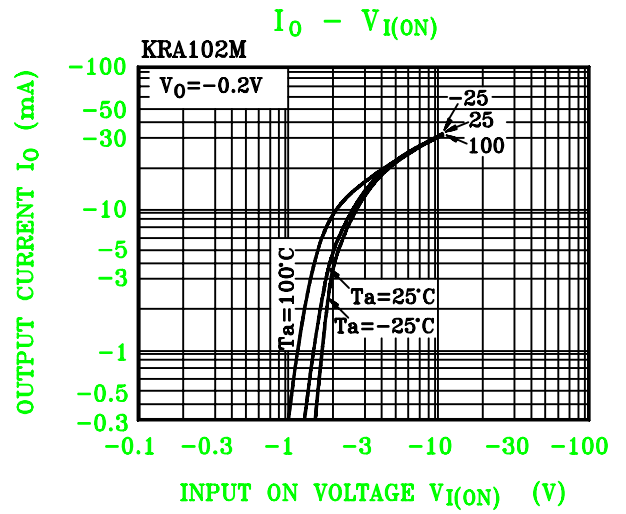
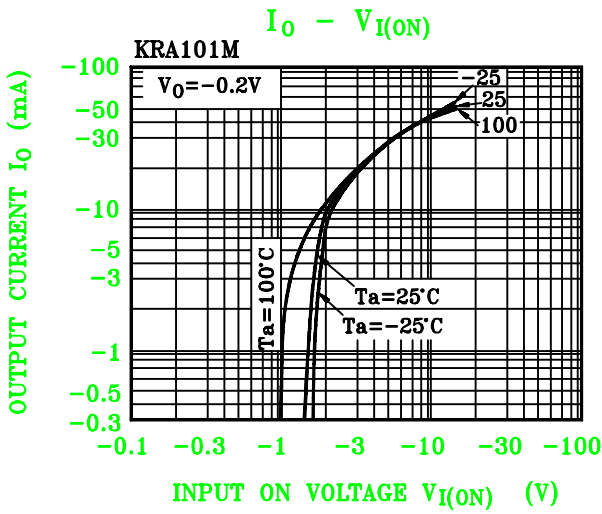

KRA101M~KRA106M

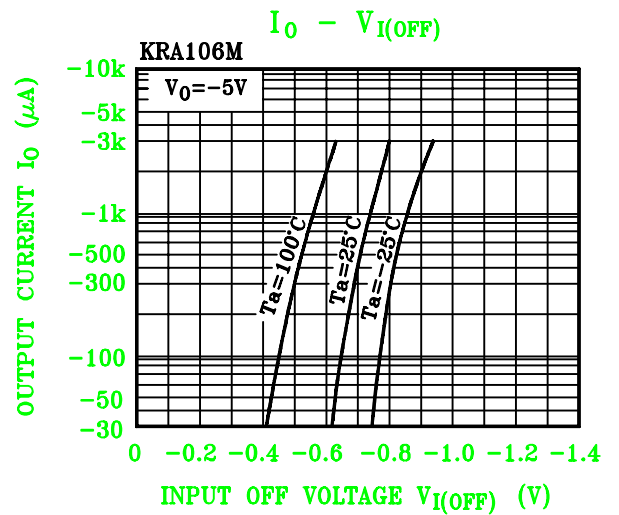
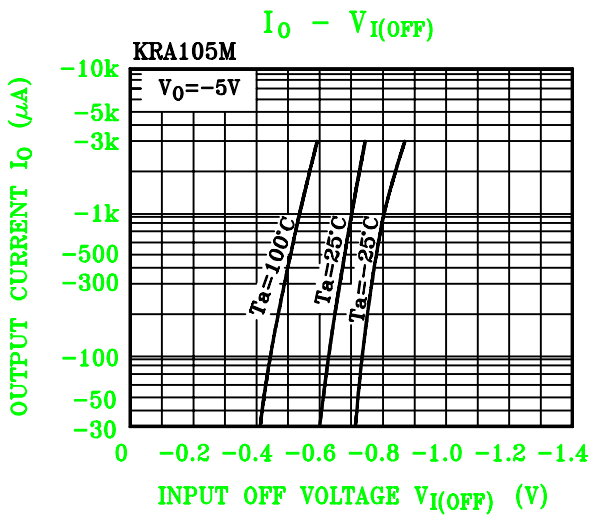
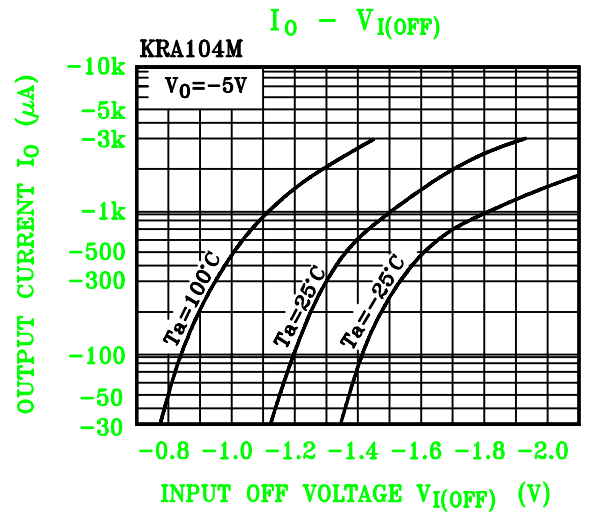
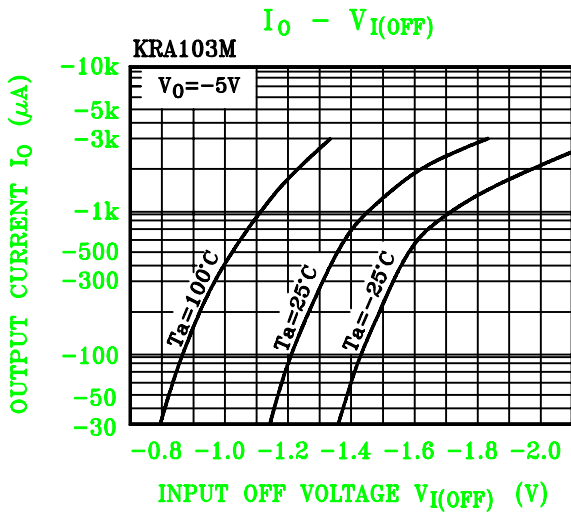
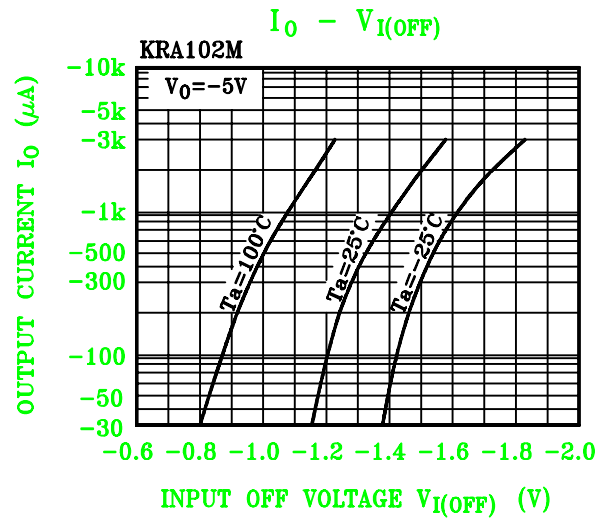
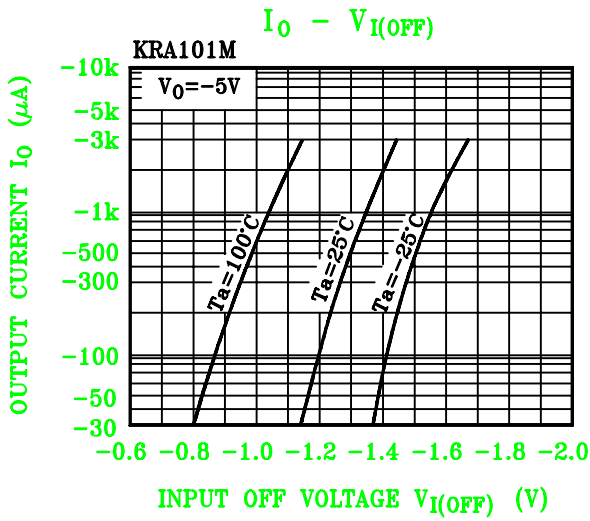

KRA101M ~ KRA106M

