

CLE-12 SERIES

Constant Current LED Driver

DANUBE

FEATURES

- EFFICIENCY UP TO 90%
- CONSTANT CURRENT LED DRIVER
- WIDE INPUT AND OUTPUT VOLTAGE RANGE
- INPUT VOLTAGE UP TO 36V
- PWM DIMMING CONTROL
- SHORT CIRCUIT AND OVERTEMPERATURE PROTECTED
- INTERNAL SMD TECHNOLOGY
- FULLY ISOLATED PLASTIC CASE WITH IP67 LEVEL
- UL 94V-0 PACKAGE MATERIAL
- RoHS COMPLIANT
- 3 YEARS WARRANTY

IP67

CE

FC

REACH
COMPLIANT

RoHS
COMPLIANT

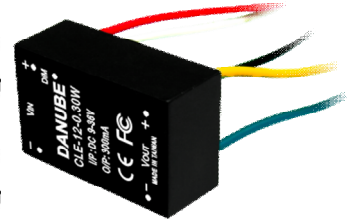
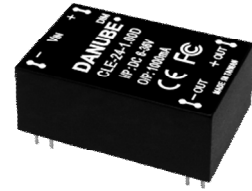

DESCRIPTION

CLE-12 series is a high efficiency, constant current and Buck-Boost DC/DC converter. The LED DRIVER operates from an input voltage 9Vdc to 36Vdc and provides an externally adjustable output current of up to 600mA and output power up to 16 watts. It is able to include the function of Over temperature protection(OTP), Over Voltage protection(OVP), PWM Dimming and ON/OFF.

The device can extensively be used for General Industrial High Power LED Lighting, Desk Lights and Room Lighting, Building and Street Lighting, Industrial Display Backlight etc.

SELECTION GUIDE

MODEL NUMBER	INPUT NOMINAL VOLTAGE (VDC)	INPUT VOLTAGE RANGE (VDC)	OUTPUT VOLTAGE RANGE (VDC)	OUTPUT CURRENT RANGE (mA)	DIMMING CONTROL	EFF (% , Typ.)
CLE-12-0.30D(W)	12	9-36	2-40	0-300	PWM	90
CLE-12-0.35D(W)	12	9-36	2-40	0-350	PWM	90
CLE-12-0.50D(W)	12	9-30	2-32	0-500	PWM	90
CLE-12-0.60D(W)	12	9-28	2-30	0-600	PWM	90

● PARTNUMBES STRUCTURE

Series	Coding Scheme	
CLE-12 Series	CLE-x1-x.x2y1zzz	<p>CLE = Series Name</p> <p>x1 = Input Voltage</p> <p>x.x2 = Output Current</p> <p>y1=Package Style(D=PINS)(W=WIRED)</p> <p>Zzz = 0~9 , A~Z or blank for market purpose.</p>

● SPECIFICATIONS

(Typical at 25°C, nominal input voltage, rated output current unless otherwise specified)

Project	Working Condition	Min.	Typ.	Max.	Unit
Input Voltage(absolute maximum)				36	VDC
Recommended Input Voltage		9	12	36	VDC
Input Filter		Capacitor			
Output Voltage range	Vin=24V	2		40	VDC
Output Current Accuracy			±4	±6	%
Output Current Stability	Vin=24V, VOUT=2-40V		±4	±6	%
Operating Frequency			350		KHz
Short Circuit Protection		Continuous			
Temperature Coefficient	-40°C~+71°C ambient			±0.03	%°C
Operating Temperature	300mA/350mA	-40		71	°C
	500mA/600mA	-40		65	°C
Storage Temperature		-55		125	°C
Humidity(D) (W)				95	%
Over Temperature Shutdown (Auto-restart after cool down)	Internal IC Temperature		145		°C
	Temperature Hysteresis		10		°C
Maximum Case Temperature				110	°C
MTBF (using MIL-HDBK 217F)	Operating Temperature 25°C	350000			Hours
Case Material		Non Conductive plastic			
Potting Material		Epoxy (UL94V-0)			
Case Size(D)(W)		31.8*20.3*12.2			mm
Weight(D)			15.6		g
Weight(W)			18		g
EMI Radiated Emissions		EN55015			
Dust Test & Waterproof Test (D) (W)		IP67			

● **PWM DIMMING AND ON/OFF CONTROL**(Leave open if not use)

Project	Working Condition	Min.	Typ.	Max.	Unit
Input Voltage Range			5	10	VDC
ON/OFF Control	ON (DIM ~ -VIN)	2			VDC
	OFF (DIM ~ -VIN)			0.2	VDC
Quiescent Input Current in Shutdown Mode	Vin=24			1	mA
PWM Frequency	For Linear Operation	100		1K	Hz
	(measured 1%~100% Dimming)				

● **PWM DIMMING AND ON/OFF CONTROL**(measured 1%~100% Dimming)

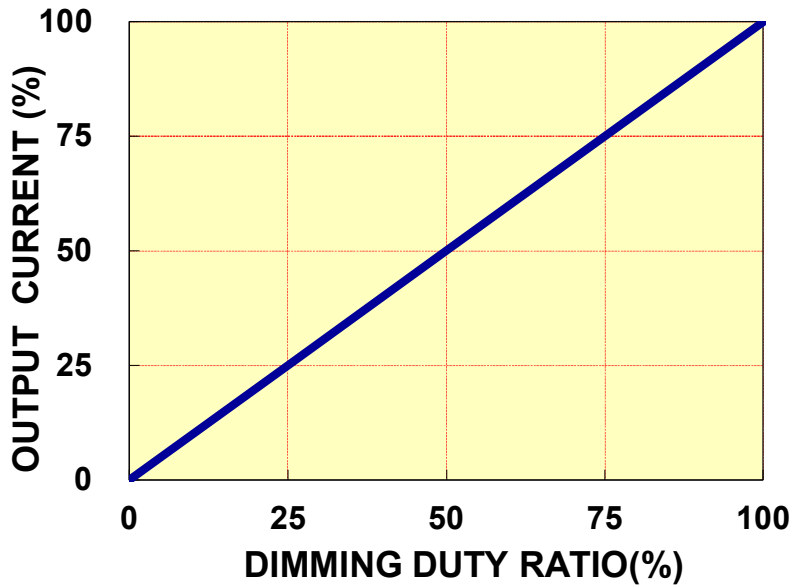
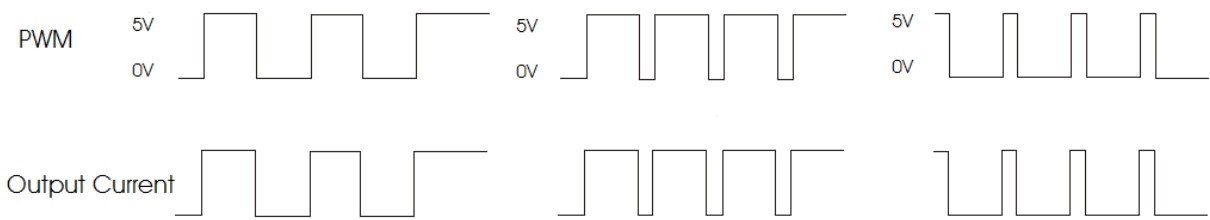

Fig.1 Dimming Duty Cycle:1%-100%

The dimming of LEDs can be performed by applying PWM signals to DIM pin.
 The above Fig.1 show good linearity in dimming application of **CLE Series**
 A logic low(below 0.2) at DIM PIN will disable the device and shut off the current flow to the LED array.

● TYPICAL APPLICATIONS

PWM Dimming control circuit

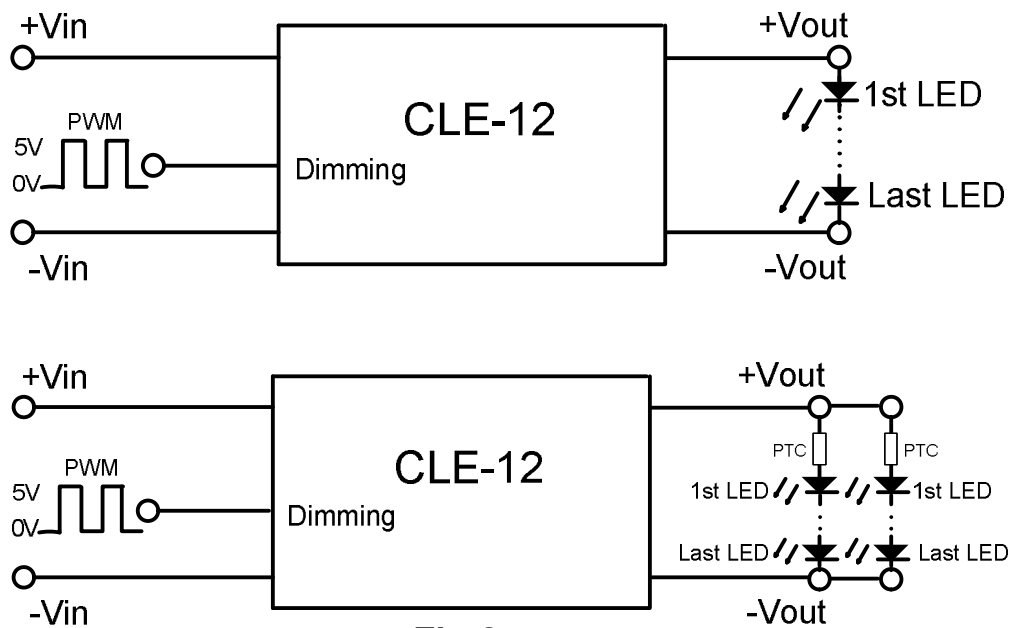
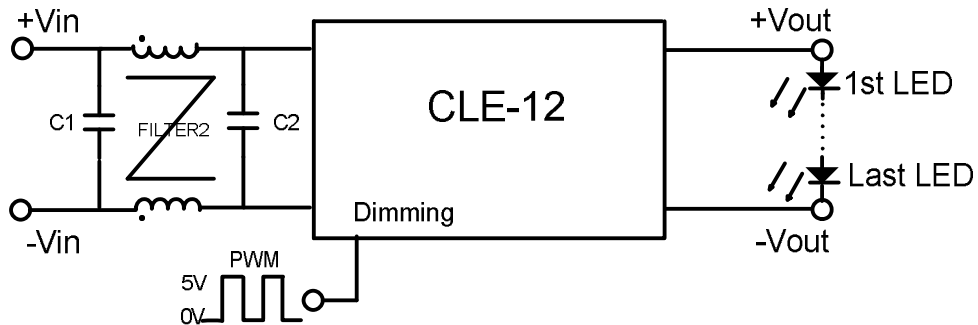

Fig.2

In actual use, if necessary to protect LED, a PTC of positive temperature coefficient may be connect to the input end of every channel or all channels, as shown in Fig.2.

EMI filter circuit



● **SAFE OPERATING AREA**

OUTPUT CURRENT 0.30A

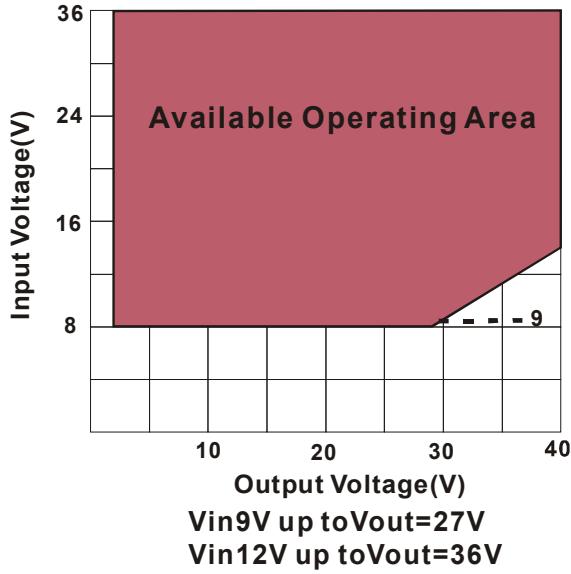

OUTPUT CURRENT 0.35A

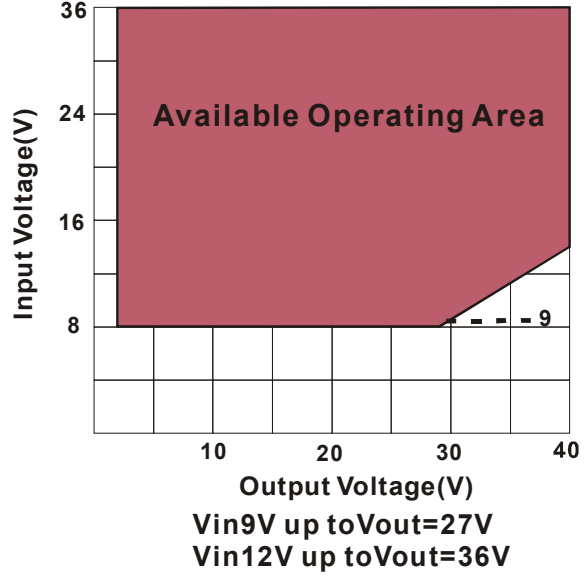

OUTPUT CURRENT 0.50A

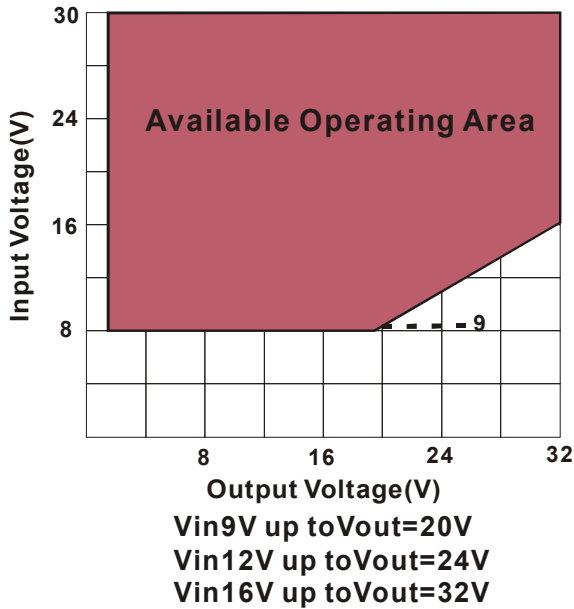

OUTPUT CURRENT 0.60A

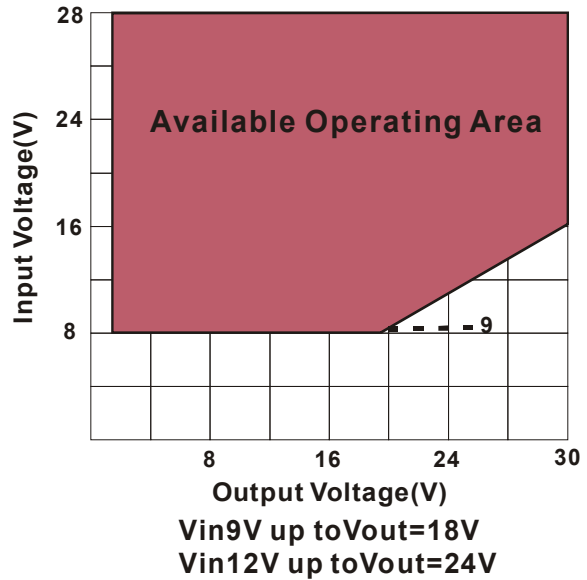

● EFFICIENCY VS. LOAD

$T_A=25^{\circ}\text{C}$

1-LED $V_F=3.6\text{V}$; 2-LED $V_F=7.2\text{V}$; 3-LED $V_F=10.8\text{V}$; 4-LED $V_F=14.4\text{V}$; 5-LED $V_F=18\text{V}$;

OUTPUT CURRENT 0.30A

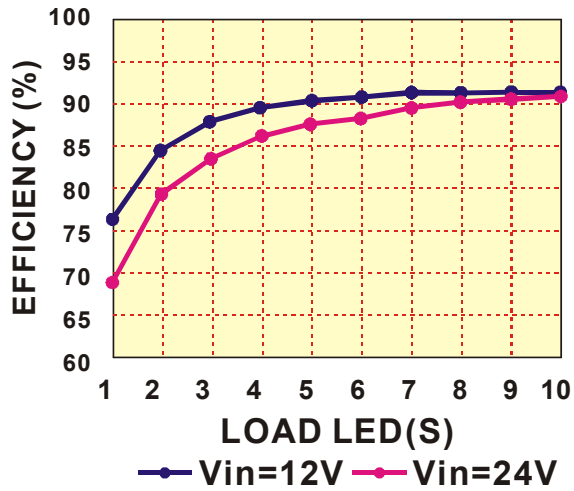

OUTPUT CURRENT 0.35A

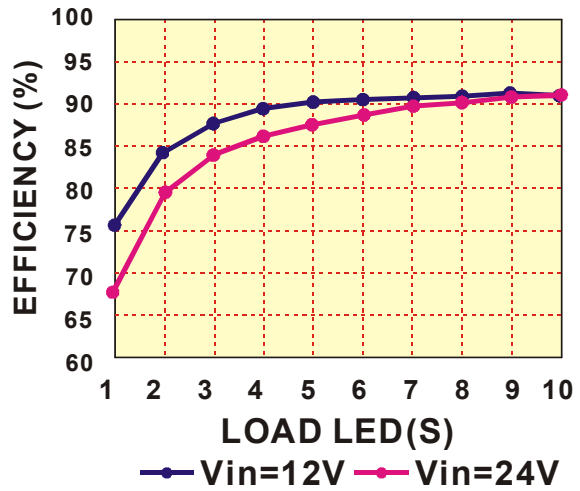

OUTPUT CURRENT 0.50A

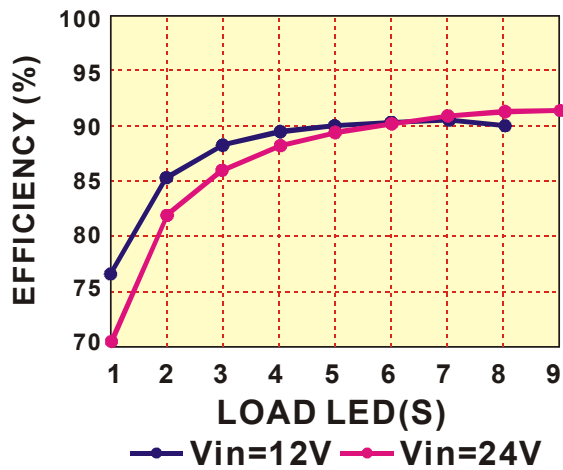

OUTPUT CURRENT 0.60A

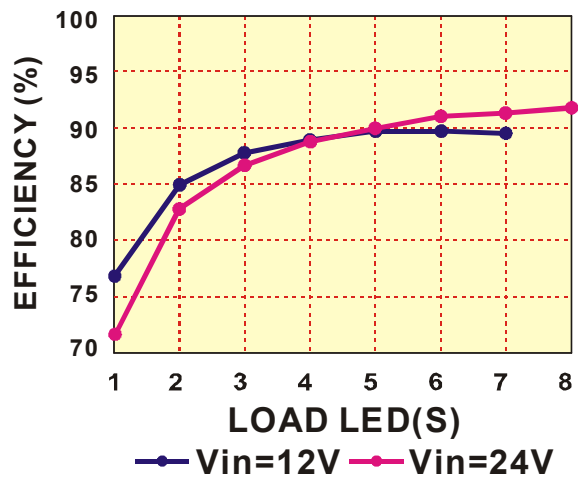

● DERATING CURVE

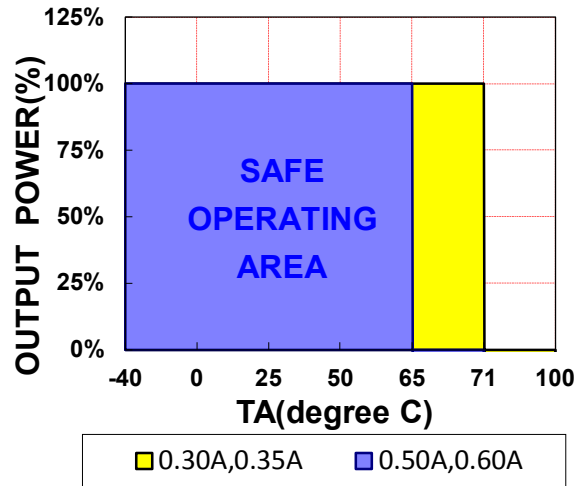

● MECHANICAL DIMENSIONS RECOMMENDED FOOTPRINT DETAILS

PACKAGE "D"

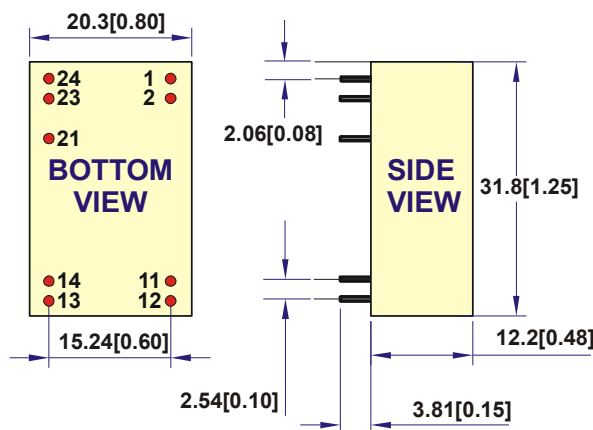

All dimensions are in mm[inches]

PINOUT		COMMENT
1 & 2	-Vin	Don't connect to -Vout
11 & 12	-Vout	LED - Connection
13 & 14	+Vout	LED + Connection
21	PWM DIM	ON/OFF/PWM Dimming Leave open if not used
23 & 24	+Vin	DC Supply

NOTE :

Pin Size is Tolerance $0.60\Phi \pm 0.05\text{mm}$

All dimensions are in mm [inches]

Tolerance .X or .XX= $\pm 0.5\text{mm}$

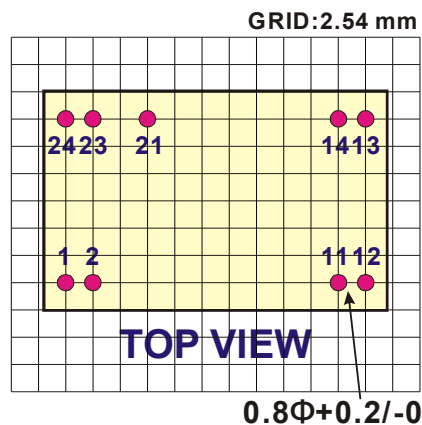

PACKAGE "W"

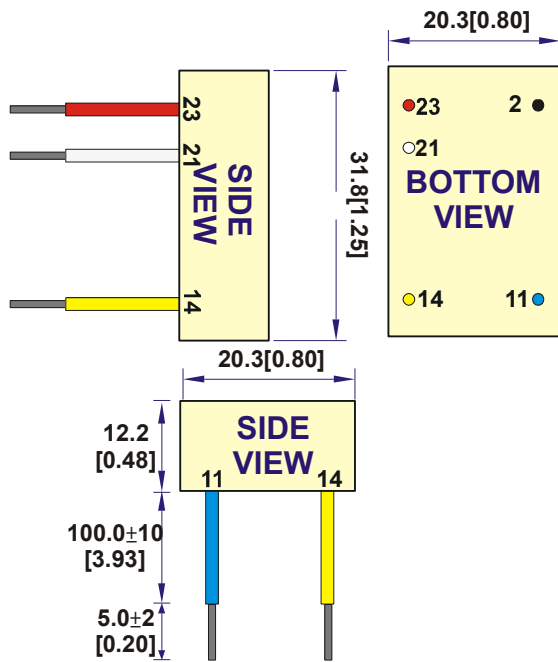

All dimensions are in mm[inches]

PINOUT		COMMENT
2 (Black)	-Vin	Don't connect to -Vout
11 (Blue)	-Vout	LED - Connection
14 (Yellow)	+Vout	LED + Connection
21 (White)	PWM DIM	ON/OFF/PWM Dimming Leave open if not used
23 (Red)	+Vin	DC Supply

NOTE:

All dimensions are in mm [inches]

1. Case Tolerance .x or .xx ±0.5mm

2. Wire outside diameter=1.6mm ±0.1

3. Wire core diameter =0.75mm ±0.1

4. Wire is UL 3385/CAS TEM listed #22AWG /300V /105°C
Rated

FOR MORE INFORMATION CALL:

Danube Enterprise Co., Ltd.

Tel: 886-7-3755165

Fax: 886-7-3755330

E-mail: danube@ms10.hinet.net

Home Page

<http://www.danube.com.tw>
