



SPECIFICATION for LCM

CUSTOMER	
MODEL NO.	VG-17H29-TLT-B
DATE ISSUE	JULY , 14, 2006

SUPPLIER APPROVAL

DESIGNED	CHECKED	APPROVED
		
REMARKS :		

CUSTOMER APPROVAL

DESIGNED	CHECKED	APPROVED
REMARKS :		

VODA TECH CO., LTD

- R & D : 602-ho JeljonTowerII, 159-4 Jungja-dong, Bundang-gu, Seongnam-si, Gyeonggi-do,
Korea (463-470)
TEL : 82-31-713-1640 / FAX : 82-31-713-1695
- FACTORY : 433-8, Mogok-dong, Pyeongtaek-si Gyeonggi-do, Korea (459-040)
TEL : 82-31-612-2200 / FAX : 82-31-668-9400

[REVISION RECORD]

Preliminary

REV.NO.	DATE	CONTENTS	PAGE	REMARKS
0	Oct,06, 2005	Preliminary release	All	

[REVISION INDEX]

Page	1	2	3	4	5	6	7	8	9	10	11	12	13	14	15			
Rev. No.	0	0	0	0	0	0	0	0	0	0	0	0	0	0	0			
Page																		
Rev. No.																		

CONTENTS

1. **Scope**
2. **Features**
3. **General information**
4. **Mechanical Specifications**
5. **Absolute Maximum Ratings**
6. **Electrical Characteristics**
7. **Electro – Optical Characteristics**
8. **I/O Terminals**
9. **General Precautions**
10. **Dimensional Outline**
11. **Packing Specification**

1. Scope

This specification defines overall terms and inspection standards for LCD module supplied by VODA tech co.,Ltd.

If the event of unexpected problems or unspecified items may occur, we will negotiate and agree to solutions with customer.

2. Features

- Transmissive type
- TFT(Thin Film Transistor) mode
- i8080 series 16bit parallel interface with on-chip display RAM
- Stand-by, Still and Full mode are available
- Low Power consumption
- Display terminals for HHP application products

3. General information

Items	Specification
Number of Pixels	176(W) x RGB x 220(H) dots
Driver Element	Transmissive and Negative a-Si TFT Active matrix
Display Color	65K colors
Display mode	Normally white
Viewing Direction	12 o'clock
Interface	16-bit parallel, i8080 series
LCD driver	HD66889 by Hitachi
Back Light	White-color, 3-chip with Light-guider
Others	-

4. Mechanical Specifications

ITEM		Width	Height	Thickness	Units
Dimensional Outline		38.5±0.2	73.76±0.2	2.9 max	mm
Number of dots	Main	176xRGB	220	-	Dots
LCD area	Main	35.9	49.2	-	mm
Active area	Main	31.68	39.6	-	
Pixel pitch	Main	0.06	0.18	-	
Weight (Typical)		8			g

5. Absolute Maximum Ratings (Ta = 25°C)

ITEM	Symbol	Min.	Max.	Unit	Note
LC Operating voltage *1)	V _{OP}	2.8(Typ.)		V	25±5°C
Operating temperature	T _{OP}	-20	+60	°C	
Storage temperature	T _{ST}	-30	+70		
Operating Ambient Humidity * 2)	H _{OP}	10	*3)	%RH	
Storage Humidity * 2)	V _{OP}	10	*4)	%RH	

NOTE:

*1) Liquid Crystal driving voltage.

Due to the characteristics of LC Material, this voltage vary with environmental temperature.

*2) Non-condensation.

*3) Temp. ≤ 60°C , 90% RH MAX.

*4) Temp. > 60°C , Absolute humidity shall be less than 90% RH at 60°C

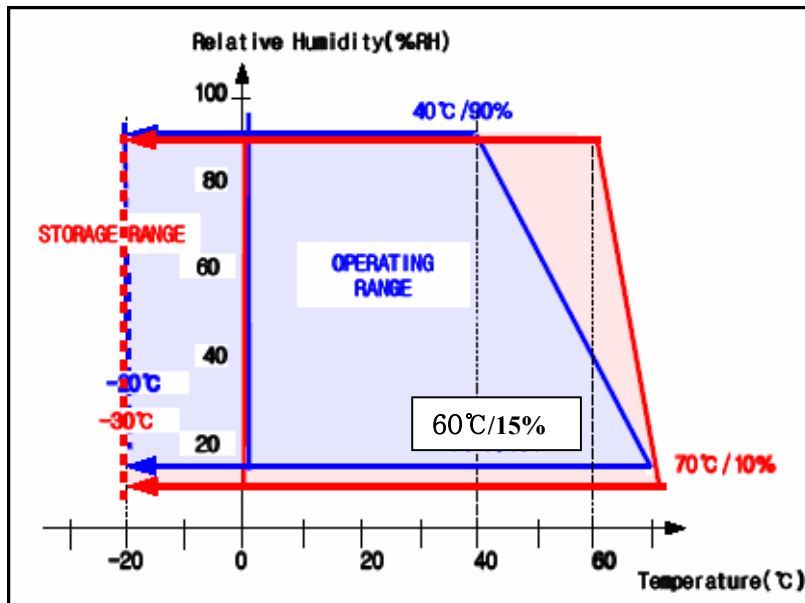

6. Electrical Characteristics

($T_a = 25^\circ\text{C}$)

ITEM	Symbol	Condition	Min.	Typ	Max.	Unit	Note	
Supply Voltage	VBAT	-	2.8	3	6	V		
Input voltage	“H” level	V_{IH}	-	$0.7 \times V_{DD}$	2.8	VDD	V	
	“L” level	V_{IL}	-	VSS	-	$0.3 \times V_{DD}$	V	
Output voltage	“H” level	V_{OH}	$V_{DD} = 2.8\text{V}$ $I_{OL} = 0.06\text{mA}$	$V_{DD} - 0.3$	-	$V_{SS} + 0.3$	V	
	“L” level	V_{OL}	$I_{OH} = -0.06\text{mA}$	VSS	-	VDD	V	
Current consumption	VBAT	IBAT	VBAT=3V	-	120	150	mA	1) 2) 3)

NOTE:

Note 1) Main full black

Note 2) No dimming

Note 3) VBAT = 3V, $T_a = 25^\circ\text{C}$

7. Electro – Optical Characteristics

ITEM	Symbol	Temp.	Min.	Typ.	Max.	Unit.	Note	
Response time	Tr+Tf	25 °C	-	25	40	msec	3)	
Transmittance	T(%)		-	7	-	%	6)	
Viewing angle	ϕ	25 °C (C/R \geq 10)	+45/-15	-	-	deg.	1), 4)	
	θ		+45/-45	-	-			
Contrast ratio	C/R	25 °C	300	350	-	-	2)	
Brightness	-		150	180	-	Cd/m ²	6)	
White uniformity	-		-	80	-	%	7)	
Color Gamut	S(%)		40	50	-	%	5)	
Color of CIE coordinate	White		x	0.2975	0.3012	0.3053	-	6)
			y	0.3131	0.3161	0.3191	-	
	Red		x	0.5887	0.5923	0.5958	-	
			y	0.3232	0.3239	0.3248	-	
	Green		x	0.3300	0.3318	0.3350	-	
			y	0.5785	0.5808	0.5816	-	
	Blue	x	0.1486	0.1491	0.1497	-		
		y	0.1148	0.1169	0.1194	-		
Flicker	F	-	-	7	%	8)		
Cross talk		-	-	6	%	8)		

NOTE:

*1) With Polarizer

Note 1) Definition of ϕ and θ

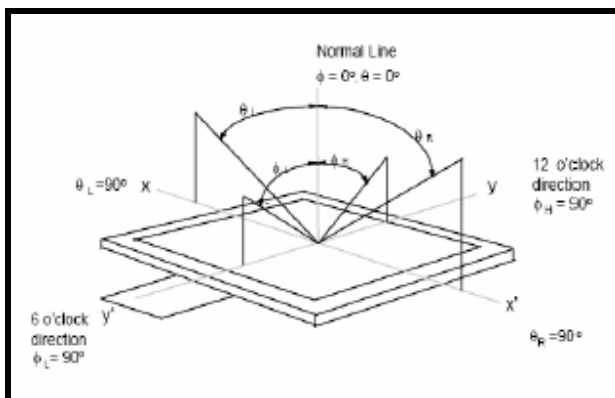

Note 2) Contrast ratio(C/R)

$$C/R = \frac{\text{Luminance with all pixels white}}{\text{Luminance with all pixels black}}$$

On the Panel

Note 3) Definition of response time

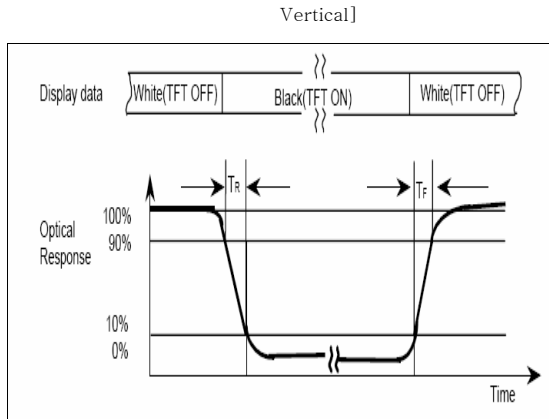

Note 4) Definition of viewing angle ($\Delta\theta$)

$$\Delta\theta = |\theta_1 - \theta_2|$$

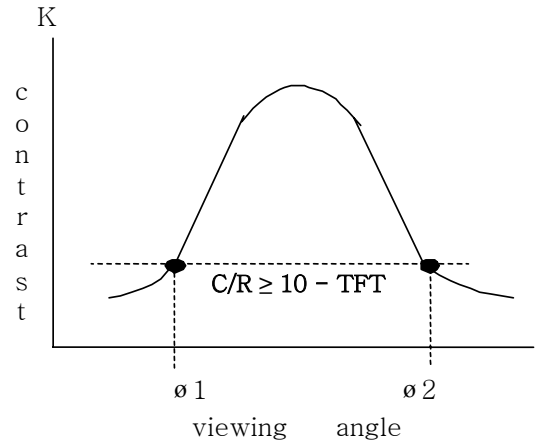

Note 5) The definition of color Gamut

$$\text{Color Gamut: } S(\%) = \frac{\text{RGB Triangle Area}}{\text{NTSC Triangle Area}} \times 100\%$$

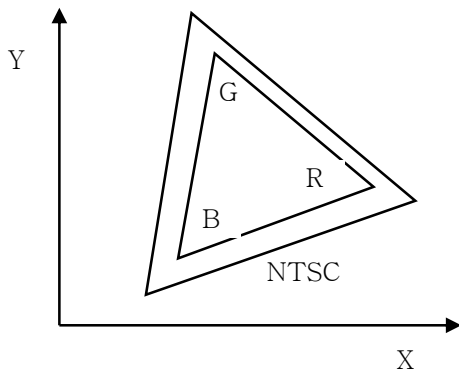

Note 6) Optical measuring system

(Temperature regulated chamber)

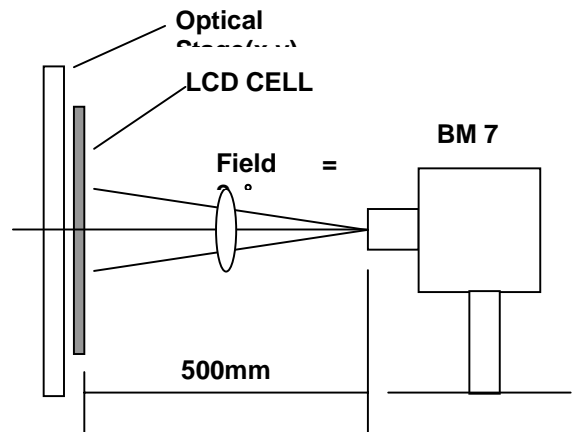

Note 7) Measurement point for luminance and luminance uniformity

Preliminary

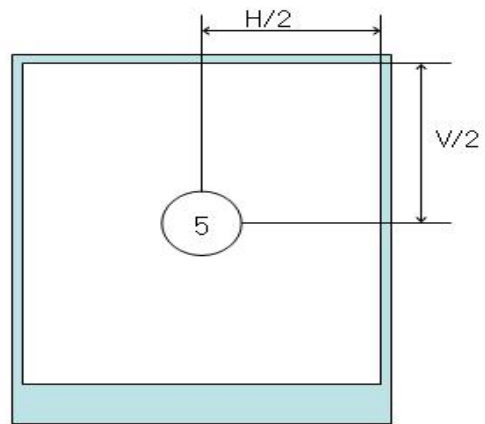
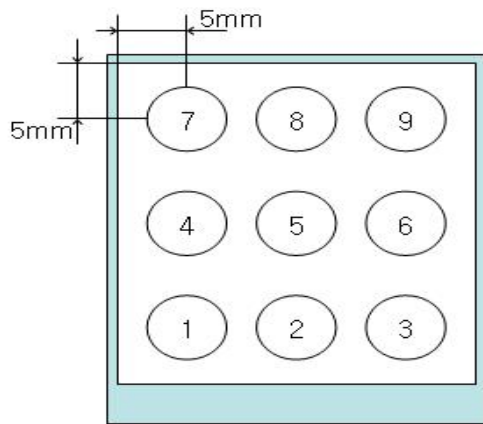

[Measurement point for luminance uniformity]

[Measurement point for surface luminance]

Note 8) Definition of Flicker level

$$F = \frac{\text{Flicker-Voltage-pp} \times 100\%}{\text{LMD-Voltage-dc}}$$

One maximum value of three estimated values

For this test, an LMD(Light Measurement Device) is needed with adequate response time to track any visible rate flicker component and with a voltage level output proportional to luminance intensity.

Backlight current : $I_B = 15\text{mA} \times 3$

Measurement distance : 50Cm

Test Pattern : Horizontal stripe pattern

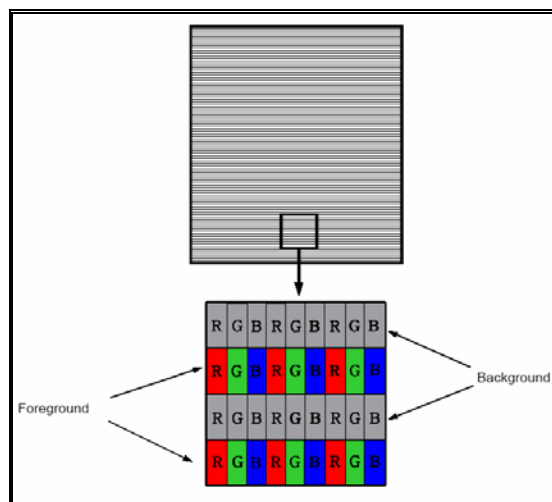

Note 9)

$$\text{Cross talk} = \frac{(L_A - L_B) \times 100\%}{L_A}$$

L_A = Luminance of A

L_B = Luminance of B

Measurement direction : $\phi = 0, \theta = 0$

Measurement distance : 50Cm

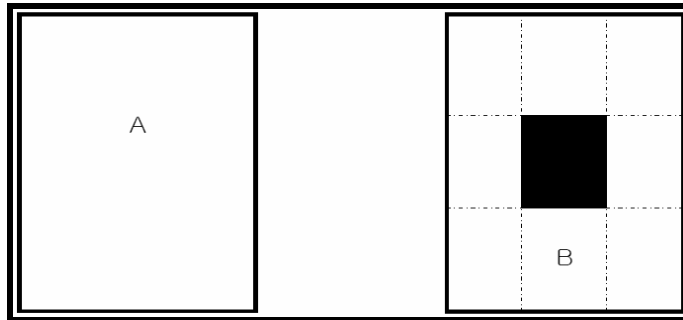

8. I/O Terminals

8-1. I/O connection

No.	Symbol	I/O	Description
1	VCC1	Power	Logic Supply Voltage.
2	VCC2	Power	
3	VCC3	Power	
4	X+	I	Touch Sensor Control pin.
5	Y+	I	
6	X-	I	
7	Y-	I	
8	D15	I/O	16 bits_Bi_Directional Data Bus
9	D14	I/O	
10	D13	I/O	
11	D12	I/O	
12	D11	I/O	
13	D10	I/O	
14	D9	I/O	
15	D8	I/O	
16	D7	I/O	
17	D6	I/O	
18	D5	I/O	
19	D4	I/O	
20	D3	I/O	
21	D2	I/O	
22	D1	I/O	
23	D0	I/O	
24	CSB	I	Chip select
25	RESETB	I	System Reset
26	RS	I	Index Resistor/Data
27	WRB	I	Write(Write/Read)
28	RDB	I	Read (Enable)
29	VSS1	GND	Ground
30	VSS2	GND	
31	VSS3	GND	
32	NC1	-	
33	LED_A	I	BLU Anode Power
34	NC2	-	
35	LED_K	I	BLU Cathode Power

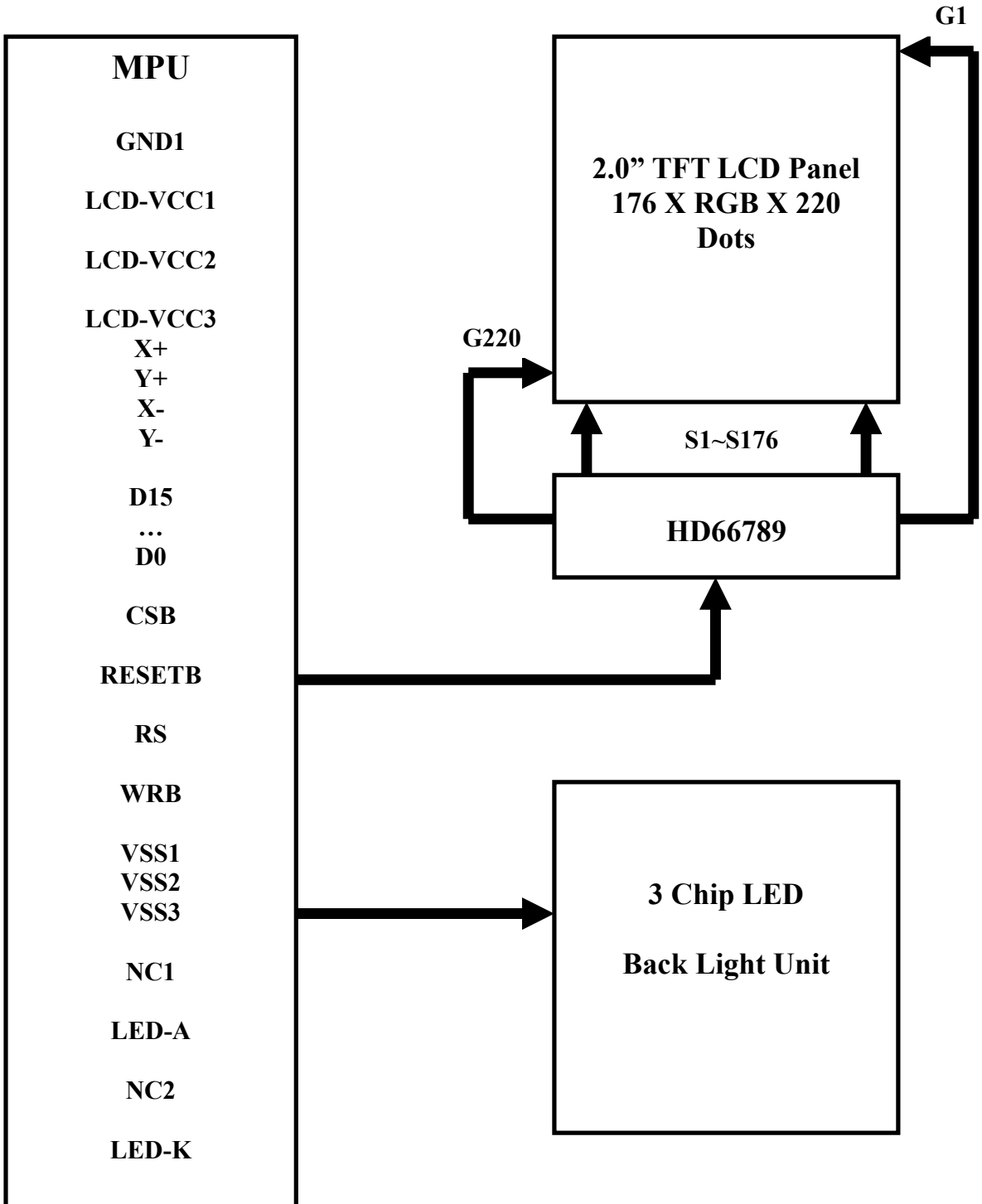

8-3. Initializing sequence

8-3-1. hd66789

Initializing Sequence

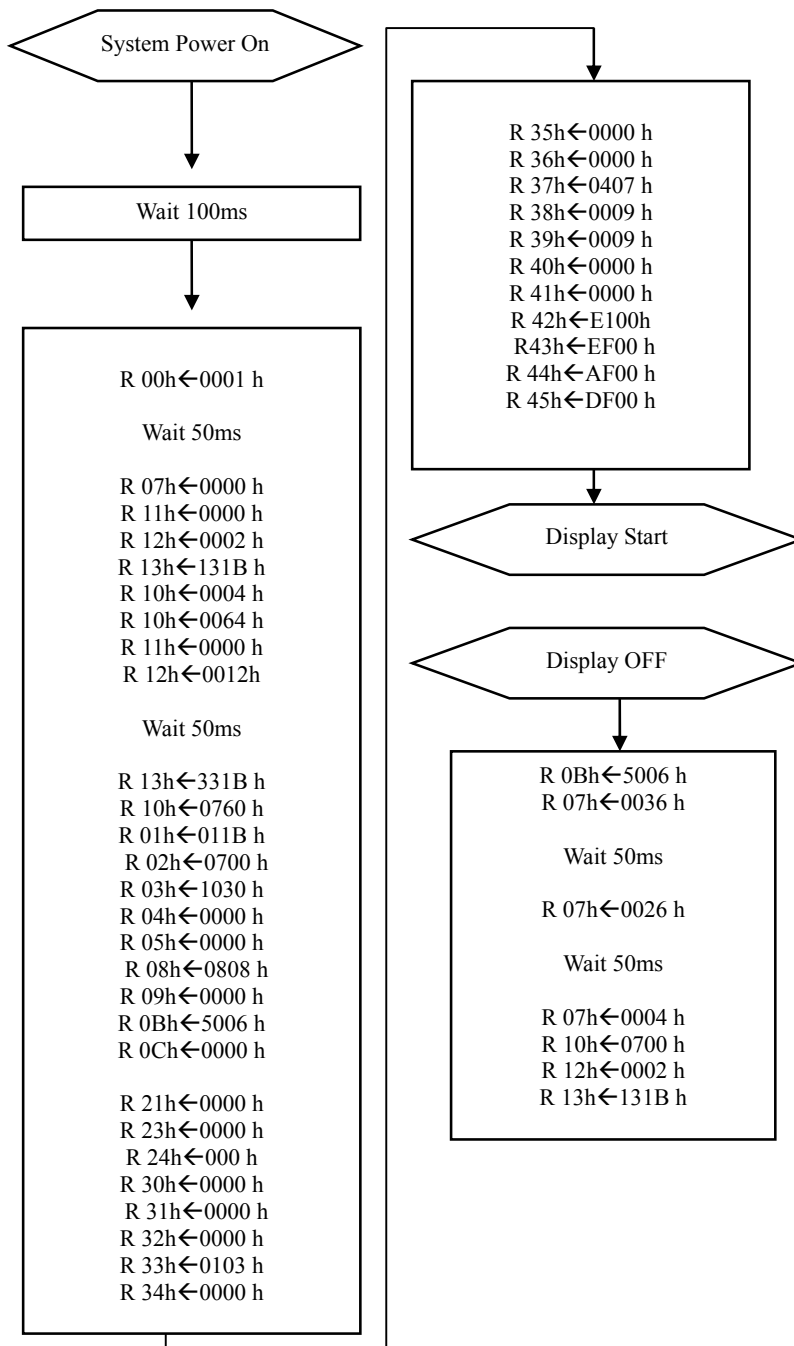

9. General Precautions

9-1. Handling

- Assembled, LCD module should be firmly attached to the set.
Do not bent or twist.
- Refrain from strong mechanical shock and forces to the module.
It may cause improper operating or damage to the module.
- Do not touch, press or rub the display panel with hard or stiff tools or subjects.
The polarizer is easily damaged.
- Wipe off water or oil drop immediately
If you leave drop for a long time, stain and discoloration may occur.
- When cleaning the surface of polarizer, use soft cloth with solvent like Isopropyl or Ethyl alcohol or Hexane.
Do not use Water, Ketone, Acetone, Ethyl alcohol, Toluene, Ethyl acid, Methyl chloride.
- Be care full of applying HCFC, Chlorine(CL), Salfur(S), Spittle, Fingerprint to ITO pattern
These may cause ITO corrosion.
- When handling the LCD module, put on a soft glover like finger-glover.
- Protection film on the polarizer shall be slowly peeled off just before use,
so that the electrostatic charge can be minimized.
- Do not touch pads or pins of interface directly with bare hands.
- Protect the module from static electricity, it may cause damage to CMOS LSI.
- If the liquid crystal leaks from the panel it should be kept away from the eyes and mouths.
In case of contact with skins, wash away thoroughly with soap and water.

9-2. Operation

- Do not input any signals before power is turned on.
- Do not connect or disconnect the module on the state of Power-ON.
- Power supply should be turned on or off according to Power ON/OFF sequence.
- Supply voltage within the specified voltage limit, the maximum rating, higher voltage cause the shorter LCD life or damaged.
- Avoid condensation of water, It may cause improper operation or disconnection of electrode.
- Do not leave LCD module in direct sunlight and strong ultraviolet ray for many hours.
At that time the liquid crystal shall be deteriorated by ultraviolet.

9-3. Storage

- Do not leave the module in high temperature and humidity for a long time.
It is recommended to store the module in the place with temperature from 0 to 35℃
and relative humidity of less than 70%.
- Do not store the LCD module in the direct sunlight.
- Store the module in a dark place without sunlight and fluorescent.
- Avoid intensive shock and falls from a height.

10. Dimensional Outline
Refer to additional drawing

Preliminary

35-PIN TABLE

NO.	SYMBOL
1	VCC
2	VCC
3	VCC
4	X+
5	Y+
6	X-
7	Y-
8	D15
9	D14
10	D13
11	D12
12	D11
13	D10
14	D9
15	D8
16	D7
17	D6
18	D5
19	D4
20	D3
21	D2
22	D1
23	D0
24	/CS
25	/RESET
26	RS
27	/WR
28	/RD
29	VSS
30	VSS
31	VSS
32	NC
33	LED_AN
34	NC
35	LED_CA

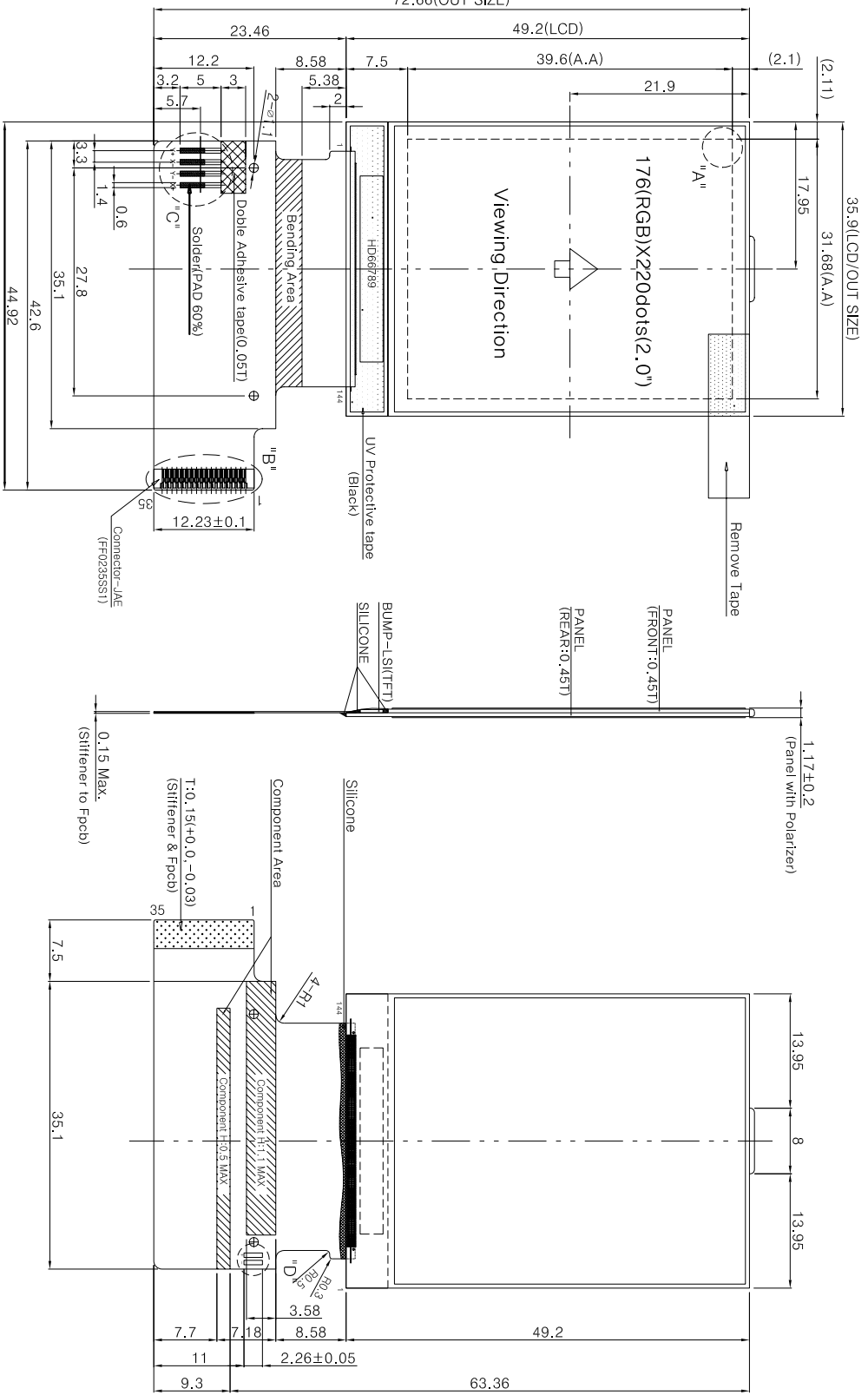
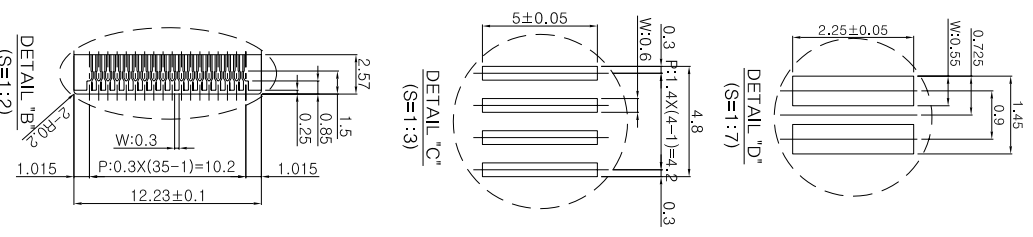

NOTES

1. Display type : 65K, TFT, T/M, Negative
2. Driver LSI : HD66789
3. Operating Temperature : -20°C TO 60°C
4. Storage Temperature : -30°C TO 70°C
5. CPU I/F : 180 mode

REV.	DATE	ECN NO.	DESCRIPTIONS
△	Sep.29.05		Initial Release

DRW. NO.	VG17H29B(FOG TYPE)	APPROVED	J. M. KIM, 09/30. 05
REF. NO.	VG17H29-TLT-B	CHECKED	J. W. LEE, 09/30. 05
REV. NO.	00	DESIGNED	K. R. KIM, 09/29. 05
STD. TOL.	±0.2	DIM.	mm
		SCALE	N/S
		SIZE	A4
		PAGE	1/1



Handwritten signature/initials.

35-PIN TABLE

NO.	SYMBOL
1	VCC
2	VCC
3	VCC
4	X+
5	Y+
6	X-
7	Y-
8	D15
9	D14
10	D13
11	D12
12	D11
13	D10
14	D9
15	D8
16	D7
17	D6
18	D5
19	D4
20	D3
21	D2
22	D1
23	D0
24	/CS
25	/RESET
26	RS
27	/WR
28	/RD
29	VSS
30	VSS
31	VSS
32	NC
33	LED_AN
34	NC
35	LED_CA

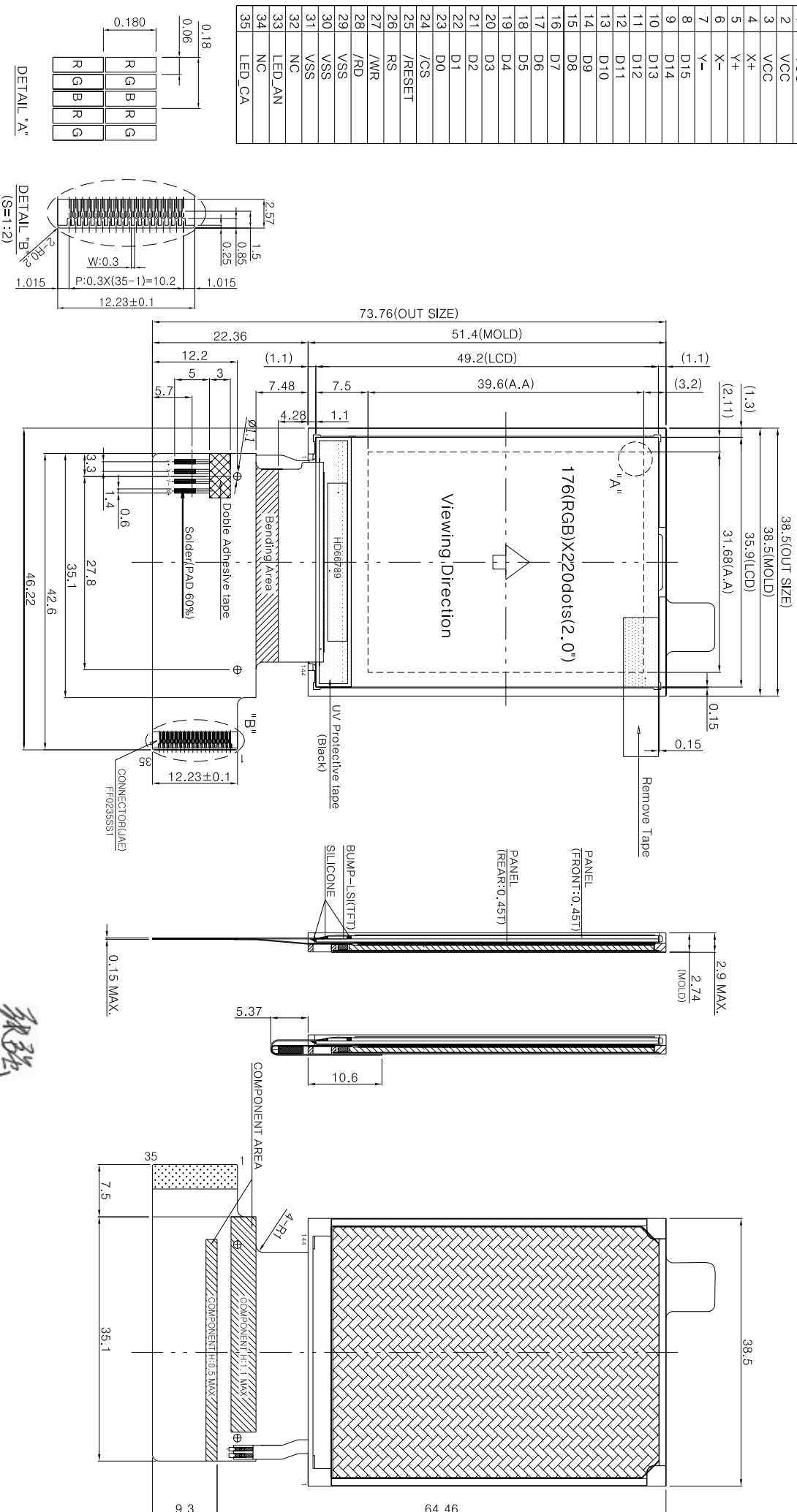

NOTES

1. Display type : 65K, TFT, T/M, Negative
2. Driver LSI : HD66789
3. Operating Temperature : -20°C TO 60°C
4. Storage Temperature : -30°C TO 70°C
5. Backlight : 3chip-white LED
6. CPU I/F : 180 mode

REV.	DATE	ECN NO.	DESCRIPTIONS	DRW. NO.	REF. NO.	REV. NO.	STD. TOL.	DIM.	SCALE	SIZE	PAGE	APPROVED	CHECKED	DESIGNED
△	Sep. 29. '05		Initial Release	VG17H29B(BLU 포함)	VG17H29-TLT-B	00	±0.2	mm	N/S	A4	1/1	J. M. KIM, 09/30. 05	J. W. LEE, 09/30. 05	K. R. KIM, 09/29. 05



11. Packing Specification

Refer to additional drawing

NO FIXED (Decision After Negotiation)