

LN80600T080IA4098

8.0 inch, 800*600 pixels resolution, RGB interface, TN-TFT-LCD

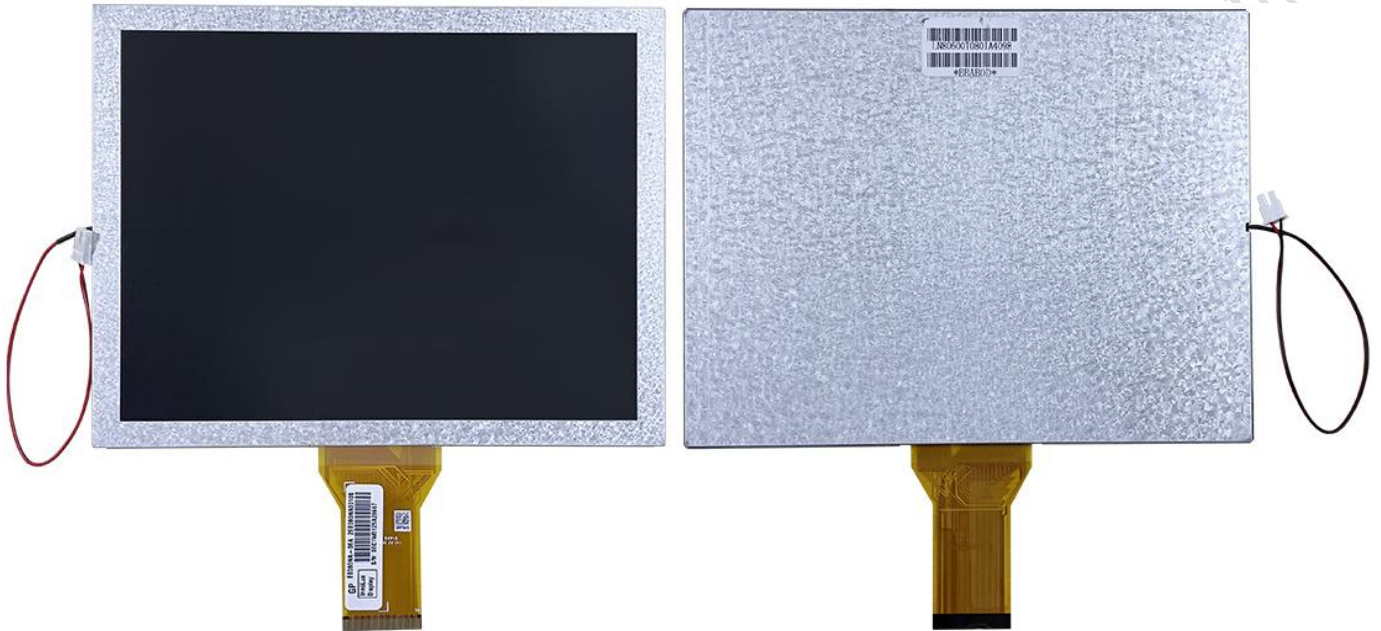

Disclaimer: The product design is subject to alternation and improvement without prior notice.

Table of Contents

1 General Feature.....	3
2 Mechanical Drawing.....	4
3 Input/Output Terminals.....	5
4 Electrical Characteristics.....	7
5 Timing Characteristics.....	7
6 Optical Characteristics.....	11
7 Environmental Reliability Test.....	14
8 Packing Capacity & Dimension.....	15
9 Appearance Inspection.....	16
10 Precautions for Use of LCD Modules.....	19
11 LCD Introduction.....	20

1 General Feature

Feature		Description	Unit
Display Spec.	Size	8.0	inch
	Resolution	800(H)*600(V)	pixels
	Pixel Configuration	RGB stripe	-
	Pixel Pitch	0.0675(H)*0.2025(V)	mm
	Viewing Direction	6 o'clock	-
Mechanical Characteristics	Outside Dimension	183.0(W)*141.0(H)*5.6(D)	mm
	Active Area	162.0(W)*121.5(H)	mm
	Polarizer	Top: sand slice Bottom: light slice	-
	Luminance	400	cd/m ²
	LED Numbers	21 LEDS	-
	Pin Order	From left to right 50PIN_0.5mm	-
	Weight	-	g
Electrical Characteristics	Interface	RGB_24bit	-
	Color Depth	16.7M	colors
	Driver Condition	3.3(Type)	V
	Driver IC	NT39419BH+NT39211H/EK9713B+EK73215	-
Temperature Range	Operating Temp.	-20~70	°C
	Storage Temp.	-30~80	°C

Note: Requirements on Environmental Protection: RoHS.

2 Mechanical Drawing

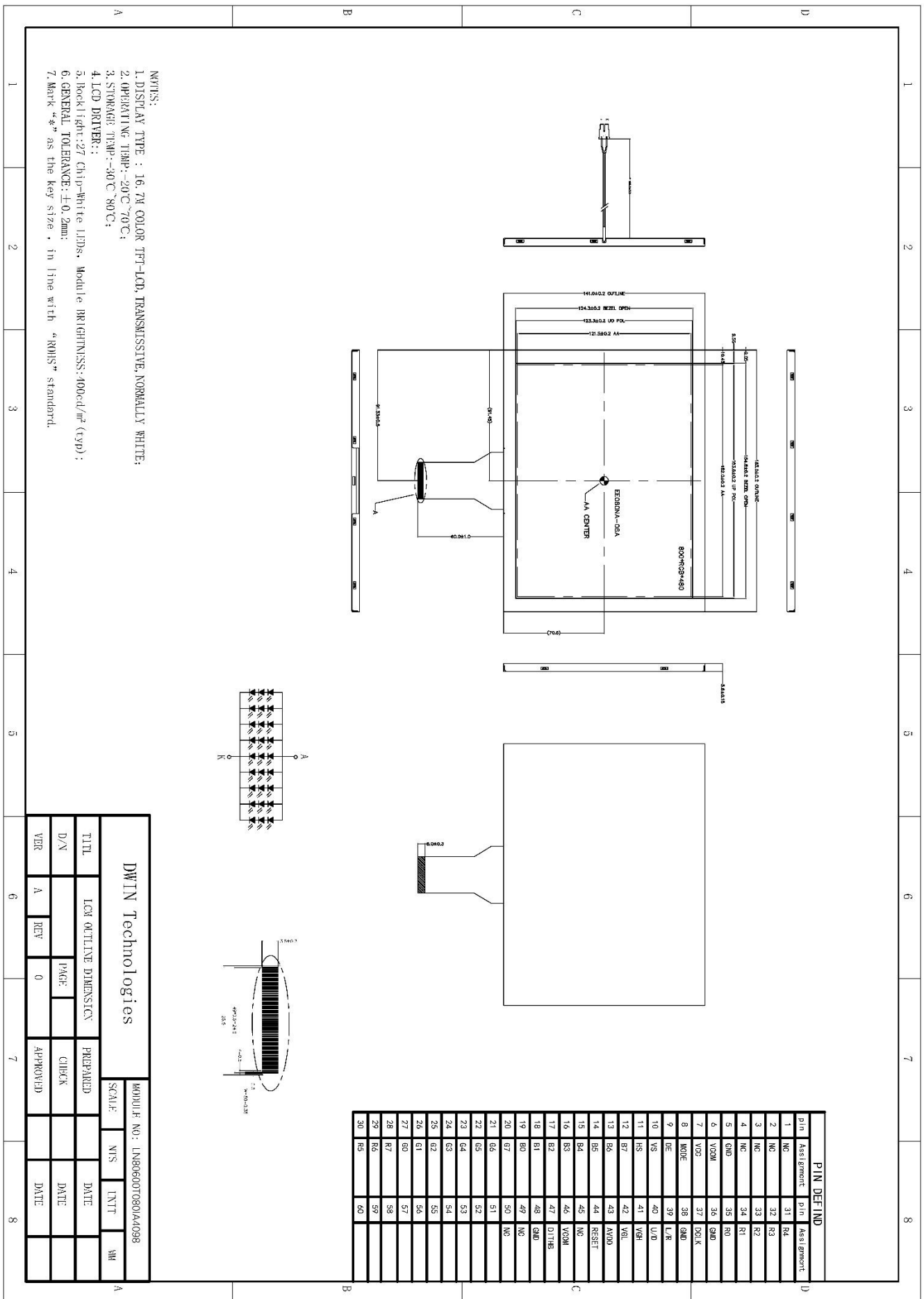

3 Input/Output Terminals

Pin NO.	Symbol	Function	Remark
1	NC	No connection	
2	NC	No connection	
3	NC	No connection	
4	NC	No connection	
5	GND	Power ground	
6	VCOM	Common voltage	
7	VCC	Power	
8	MODE	DE/SYNC mode select	
9	DE	DATA Enable	
10	VS	VERTICAL SYNC INPUT	
11	HS	Horizontal Sync Input	
12	B7	Blue data	
13	B6	Blue data	
14	B5	Blue data	
15	B4	Blue data	
16	B3	Blue data	
17	B2	Blue data	
18	B1	Blue data	
19	B0	Blue data	
20	G7	Green data	
21	G6	Green data	
22	G5	Green data	
23	G4	Green data	
24	G3	Green data	
25	G2	Green data	
26	G1	Green data	
27	G0	Green data	
28	R7	RED data	
29	R6	RED data	
30	R5	RED data	
31	R4	RED data	
32	R3	RED data	
33	R2	RED data	
34	R1	RED data	
35	R0	RED data	
36	GND	Power ground	
37	DCLK	Clock signal	
38	GND	Power ground	
39	L/R	Left/right selection	
40	U/D	Up/down selection	
41	VGH	Gate on voltage	
42	VGL	Gate on voltage	
43	AVDD	Power for analog circuit	



44	RESET	Global reset pin	
45	NC	No connection	
46	VCOM	Common voltage	
47	DITHB	Dithering function	
48	GND	Power ground	
49	NC	No connection	
50	NC	No connection	

DWIN Technologies Technical Document

4 Electrical Characteristics

4.1 Driving TFT LCD Panel

Item	Symbol	Min.	Typ.	Max.	Unit	Remark
Power Voltage	VCC	3.0	3.3	3.6	V	
	AVDD	-	10.39	-	V	
	VGH	-	19.03	-	V	
	VGL	-	-6.78	-	V	
Input Signal Voltage	VCOM	-	3.34	-	V	
Input Logic High Voltage	VIH	0.7VCC	-	VCC	V	
Input Logic Low Voltage	VIL	0	-	0.3VCC	V	

4.2 LED Backlight Specification

Item	Symbol	Min.	Typ.	Max.	Unit	Remark
Voltage for LED Backlight	VL	-	9.0	-	V	
Current for LED Backlight	IL	-	180	-	mA	
Luminance	L _v	-	400	-	cd/m ²	
Uniformity(with L/G)	Avg	70	75	-	%	
LED Life-Time	Hr	20000	-	-	Hour	

Note: 27 LEDs (3 LEDs Serial, 9 ways Parallel)

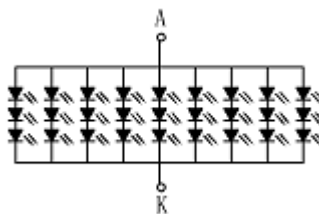

5 Timing Characteristics

5.1 Power Sequence

Power On

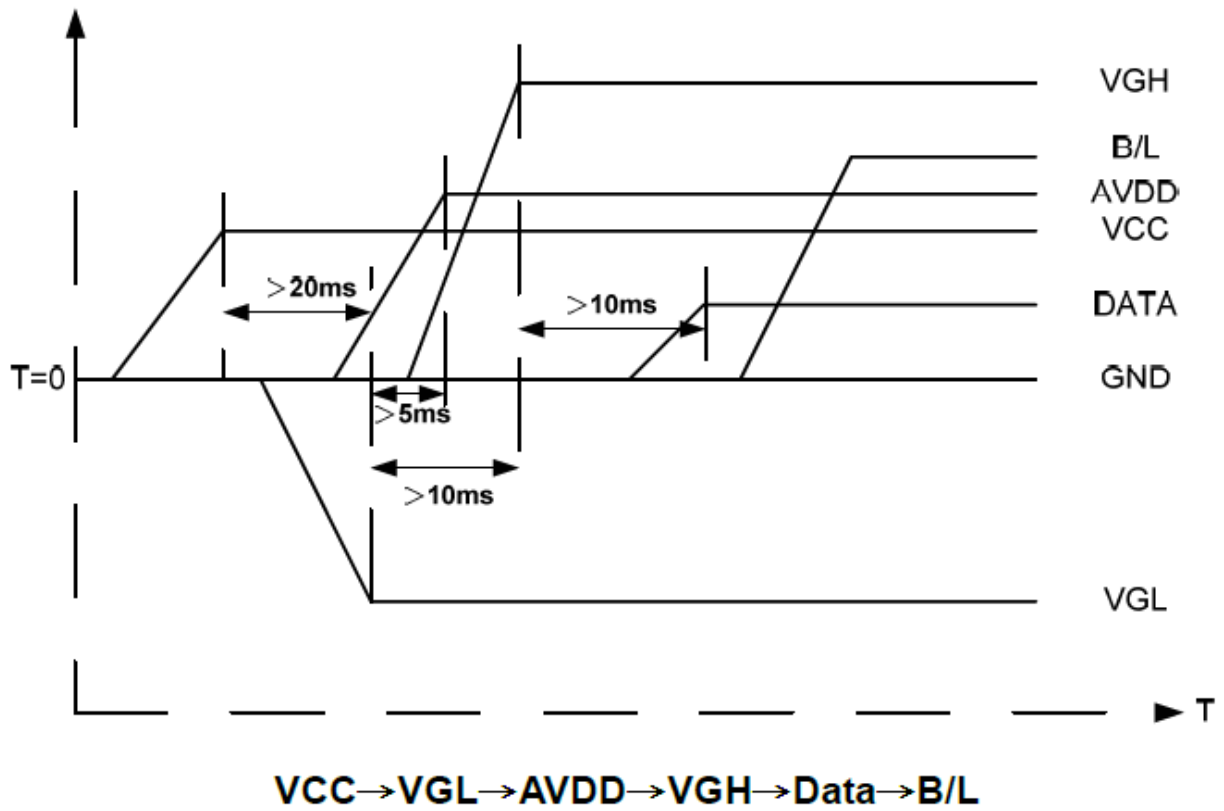

Power Off

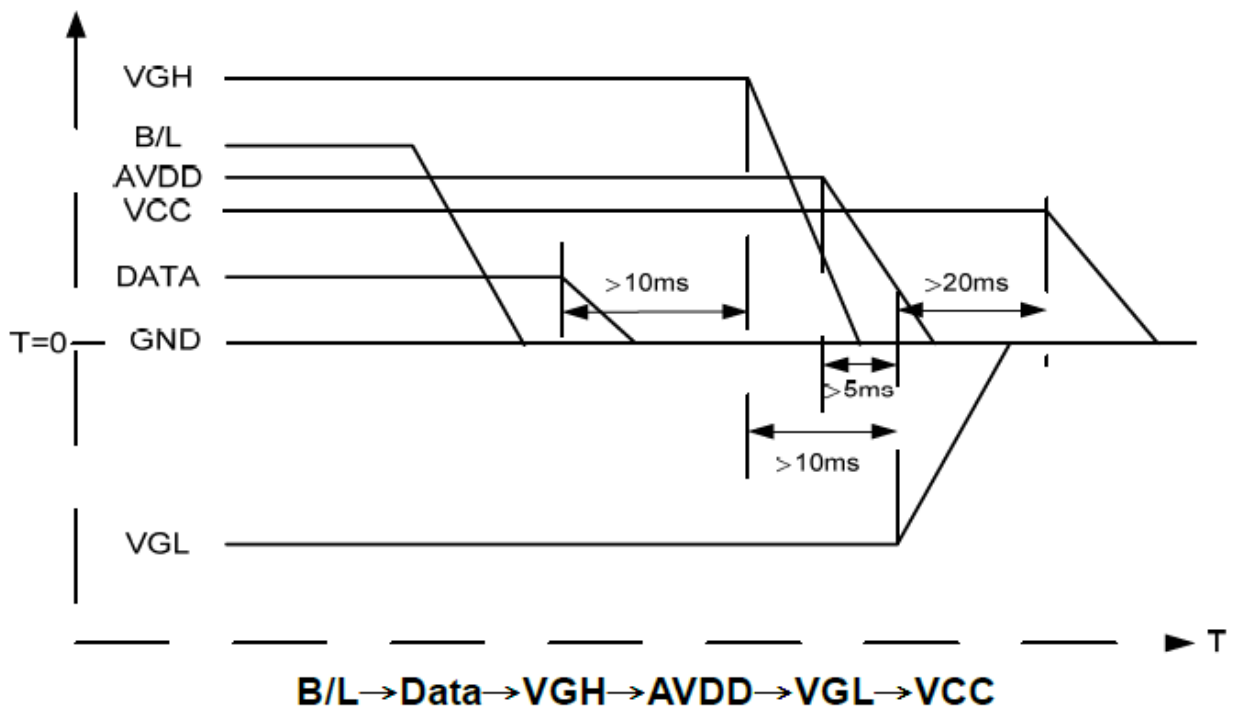

Note: Data include R0~R5, B0~B5, GO~G5, STLR, UPDN, DCLK, HS, VS, DE.

5.2 AC Electrical Characteristics

Item	Symbol	Value			Unit	Remark
		Min.	Typ.	Max.		
HS Setup Time	Thst	8	-	-	Ns	
HS Hold Time	Thhd	8	-	-	Ns	
VS Setup Time	Tvst	8	-	-	Ns	
VS Hold Time	Tvhd	8	-	-	Ns	
Data Setup Time	Tdsu	8	-	-	Ns	
Data Hole Time	Tdhd	8	-	-	Ns	
DE Setup Time	Tesu	8	-	-	Ns	
DE Hole Time	Tehd	8	-	-	Ns	
VDD Power On Slew Rate	TPOR	-	-	20	ms	
RSTB Pulse Width	TRst	10	-	-	us	
CLKIN Cycle Time	Tcoh	20	-	-	Ns	
CLKIN Pulse Duty	Tcwh	40	50	60	%	
Output Stable Time	Tsst	-	-	6	us	

5.3 Timing

Item	Symbol	Value			Unit	Remark
		Min.	Typ.	Max.		
Horizontal Display Area	thd	-	800	-	DCLK	
DCLK Frequency	fclk	-	40	50	MHz	
One Horizontal Line	th	862	1056	1200	DCLK	
HS Pulse Width	thpw	1	-	40	DCLK	
HS Back Porch(Blanking)	thb	46	46	46	DCLK	
HS Front Porch	thfp	16	210	354	DCLK	

Item	Symbol	Values			Unit	Remark
		Min.	Typ.	Max.		
Vertical Display Area	tvd	-	600	-	TH	
VS Period Time	tv	624	635	700	TH	
VS Pulse Width	tvpw	1	-	20	TH	
VS Back Porch(Blanking)	tvb	23	23	23	TH	
VS Front Porch	tvfp	1	12	77	TH	

5.4 Timing Diagram

5.4.1 Input Clock and Data Timing Diagram

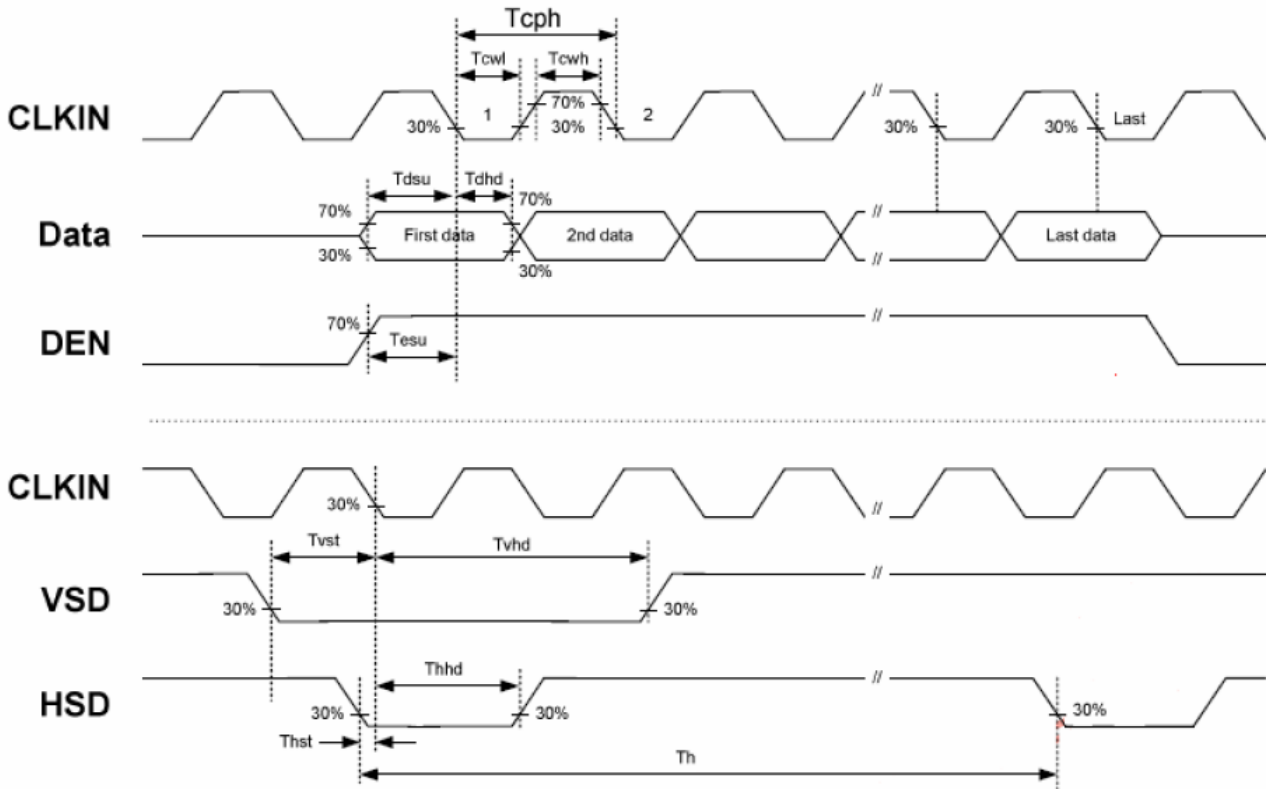

5.4.2 Horizontal Input Timing Diagram

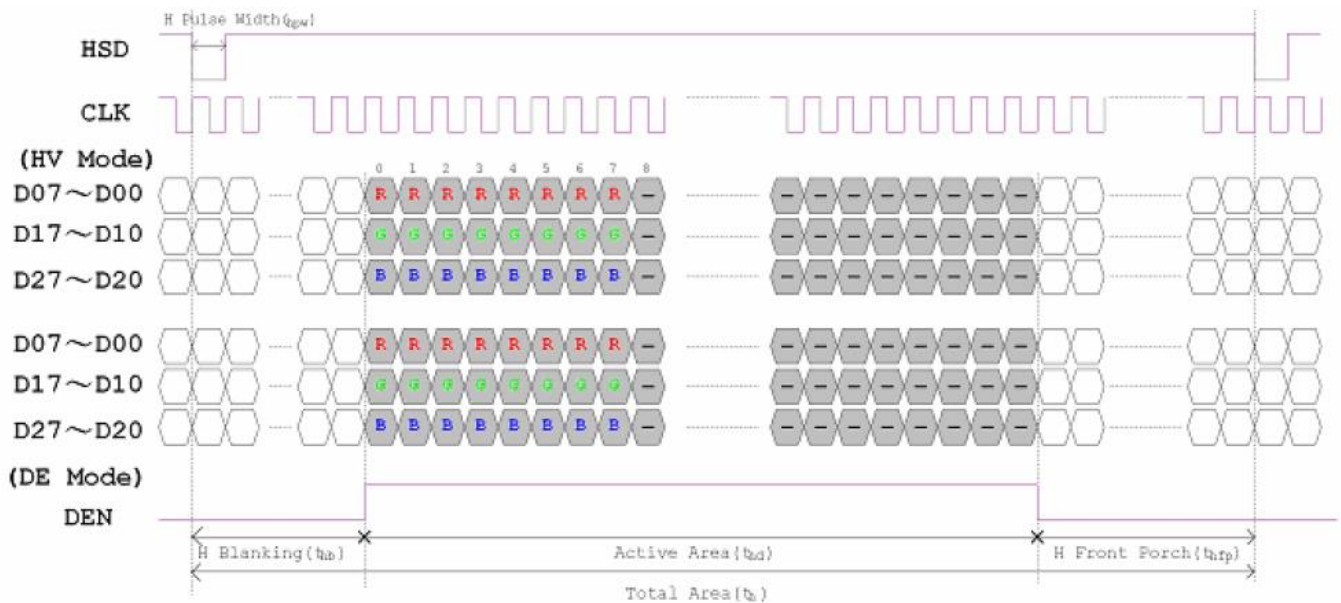

6 Optical Characteristics

Item	Symbol	Condition	Min.	Typ.	Max.	Unit	Remark
Viewing Angle	Top	$CR \geq 10$	-	50	-	Deg.	Note 2
	Bottom		-	70	-		
	Left		-	70	-		
	Right		-	70	-		
Contrast Ratio	CR	$\theta=0^\circ$	400	500	-		
Response Time	T_{ON}	$\theta=0^\circ$	-	10	20	ms	
	T_{OFF}		-	15	30	ms	
Color Chromaticity (CIE1931)	W_x	$\theta=0^\circ$	-	0.346	-		
	W_y		-	0.410	-		
	R_x		-	0.577	-		
	R_y		-	0.345	-		
	G_x		-	0.362	-		
	G_y		-	0.605	-		
	B_x		-	0.154	-		
	B_y		-	0.146	-		
Color Temperature	T_c		-	5133	-	K	

Test conditions:

IF= 180 mA, and the ambient temperature is 25°C.

Note 1: Definition of optical measurement system.

The optical characteristics should be measured in dark room. After 5 minutes operation, the optical properties are measured at the center point of LCD.

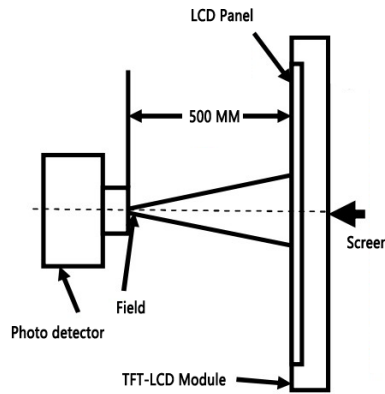

Note 2: Definition of viewing angle range and measurement system.

The viewing angle is measured at the center point of the LCD by BM-7A.

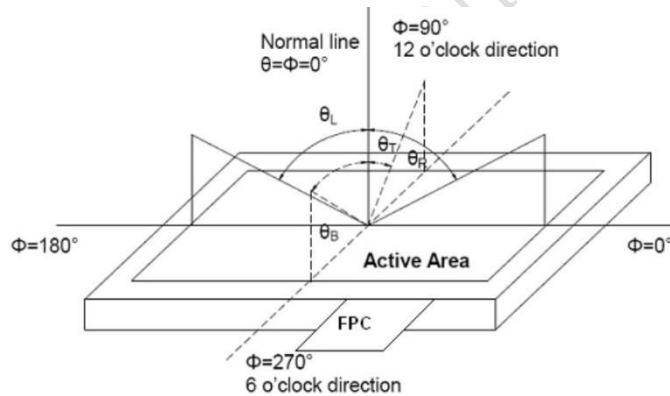

Note 3: Definition of color temperature.

When the radiation of the light source is exactly the same in the visible region and the absolute blackbody, the temperature of the blackbody is called the color temperature of the light source. Color temperature is an index to measure the degree of light source color (cold color, warm color). Warm color < 3300K, intermediate color 3300 ~ 5000K, cold color > 5000K.

Note 4: Definition of response time.

The response time is defined as the LCD optical switching time interval between “White” state and “Black” state. Time ON (TON) is the time between photo detector output intensity changed from 90% to 10%. And time off (TOFF) is the time between photo detector output intensity changed from 10% to 90%.

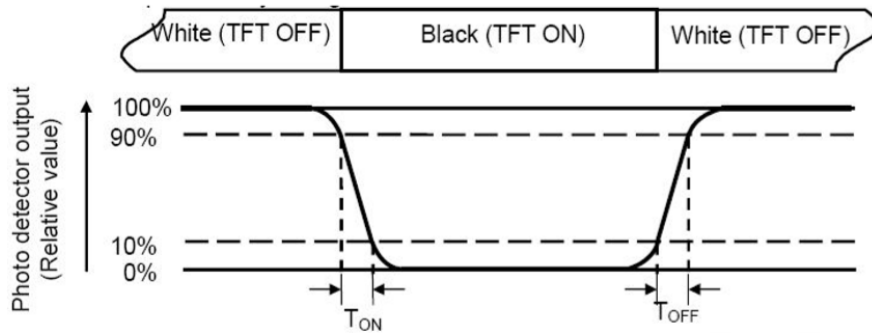

Note 5: Definition of color chromaticity (CIE1931).

Color coordinates measured at center point of LCD.

Note 6: Definition of luminance.

Measure the luminance of white state at center point.

7 Environmental Reliability Test

NO	Test Item	Condition	Remarks
1	High Temperature Operation	Ta=+70°C,48hours	IEC60068-2-1:2007 GB2423.2-2008
2	Low Temperature Operation	Ta=-20°C,48hours	IEC60068-2-1:2007 GB2423.1-2008
3	High Temperature Storage	Ta=+80°C,48hours	IEC60068-2-1:2007 GB2423.2-2008
4	Low Temperature Storage	Ta=-30°C,48hours	IEC60068-2-1:2007 GB2423.1-2008
5	Storage at High Temperature and Humidity	Ta=+60°C,90% RH max,48hours	IEC60068-2-78 :2001 GB/T2423.3-2006
6	Thermal Shock (non-operation)	-30°C /30min~ +80°C/30min, Change time: 5min,20cycles	Start with cold temperature, End with high temperature, IEC60068-2-14:1984, GB 2423.22-2002
7	ESD(non-operation)	C=150pF, R=330Ω,5point/panel Air: ±15Kv, 5times; Contact: ±8Kv,5times (Environment: 15°C~35°C,30%~60%.86Kpa~106Kpa)	IEC61000-4-2:2001 GB/T 17626.2-2006

8 Packing Capacity & Dimension

Dimension			
Dimension(mm)	183.0(W)*141.0(H)*5.6(D)		
Net Weight	-		
Packing Capacity			
Size	LCD Size and Resolution	Layer	Quantity(Pcs)
250mm(L)x200mm(W)x80mm(H)	8.0 inch 800*600	1	1
600mm(L)x450mm(W)x300mm(H)	8.0 inch 800*600	1	60

Packing instruction:

The LCD is placed in the grid, covered with a PE static bag and compactly assembled, the upper and the lower layers of the grid are protected by buffer spaces.

The LCD covered with a PE static bag and compactly assembled



placed in the grid



The upper and the lower layers of the grid are protected by buffer spaces



Packed



9 Appearance Inspection

9.1 General rules for inspection

9.1.1 Anti-static wearables (anti-static wristbands, gloves) must be worn during the inspection.

9.1.2 Do not use bare hands to touch the position of the device, golden fingers, and the surface of the screen to prevent the sweat from human hands from causing oxidation and affecting the appearance.

9.1.3 It is forbidden to stack products out of specification and handle them with care to avoid damage to components.

9.1.4 The repaired products need to be inspected to prevent rosin and tin slag from exceeding the specifications.

9.1.5 When technical documents and process documents have specific requirements for products, the technical documents and process documents shall be the main requirements.

9.2 Inspection conditions

9.2.1 The conditions of display function check

Angle: $\pm 5^\circ$;

Inspection method: visual inspection. The inspection object is 30-40cm away from the light source, and the eye is 30-40cm away from the inspection object;

Illumination: 300-500Lux;

Inspection time: 5-10S.

9.2.2 Visual inspection conditions

Angle: $\pm 45^\circ$;

Inspection method: visual inspection. The inspection object is 30-40cm away from the light source, and the eye is 30-40cm away from the inspection object;

Illumination: 800-1500Lux;

Inspection time: 5-10S.

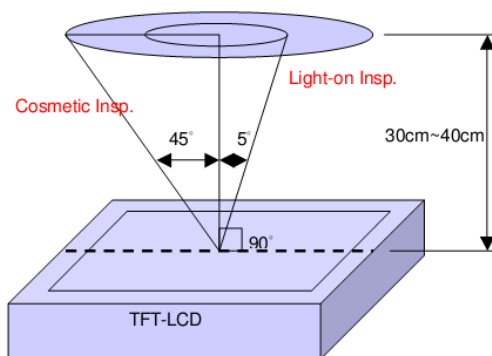

9.3 Inspection standards

Type	Test Items	Judgement Standard	Defect Category
Display state	Dead pixels	No dead pixels	
	mura	<p>From different angles, the brightness is required to be uniform. Under the 64-level grayscale or pure black interface, there should be no uneven display brightness within the viewing angle range of 45° through 6% ND FILTER. Y series (TV film) LCD screen does not have specific requirements, and the picture inspection does not affect the display as qualified.</p> 	Slight defect
	Light leakage	<p>Under the 64-level grayscale or pure black interface, there should be no obvious light leakage within the viewing angle range of 45° by visual inspection or through 6% ND FILTER. Y series (TV LCD screen) series can be without obvious visual defects.</p>	Slight defect
	Linear foreign bodies	<p>1. $W \leq 0.05$, $L \leq 2\text{mm}$, negligible; 2. $0.05\text{mm} < W \leq 0.1\text{mm}$, $L \leq 2\text{mm}$, $N \leq 3$; 3. $W > 0.1\text{mm}$, $L > 2\text{mm}$, not allowed.</p>	Slight defect
Screen surface	Within the effective area	<p>Spotted: 1. $D \leq 0.2\text{mm}$ and it is not a piece, it is not counted; 2. $0.2\text{mm} < D \leq 0.5\text{mm}$, $N \leq 3$; 3. $D > 0.5\text{mm}$, $L > 0.5\text{mm}$, $W > 0.5\text{mm}$ are not allowed; (The spotted foreign objects shall not exceed the point-line gauge $D=0.5$, and the black dot coverage shall be checked, and the spotted foreign objects shall be judged within the range of $D=0.5$)</p>	Slight defect

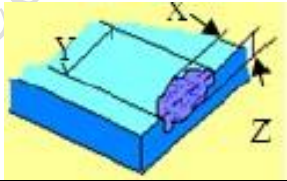
	Foreign objects Scratch Air bubbles	Linear: 1. $W \leq 0.05$, $L \leq 2\text{mm}$, ignored; 2. $0.05 < W \leq 0.1\text{mm}$, $L \leq 2\text{mm}$, $N \leq 3$; 3. $W > 0.1\text{mm}$, $L > 2\text{mm}$, not allowed.	
	Outside the effective area Foreign objects Scratches Air bubbles	Foreign objects are not checked, and bubbles are not allowed to $D > 1\text{mm}$; Non-inductive scratches of no more than $0.1 \times 8\text{mm}$ are allowed.	Slight defect
	Crack	Not allowed.	 Slight defect
	Notch	1. Does not affect the appearance from the front; 2. Does not affect the relevant alignment; 3. $X \leq 1\text{mm}$, $Y \leq 1\text{mm}$, $N \leq 2$.	 Slight defect
	Glass side Foreign objects Dirty	1. The foreign body on the side is not controlled; 2. The paint pen marks on the side are not controlled; 3. Side oily note printing is not allowed.	Slight defect
FPC	Cracks Goldfinger crease	Not allowed.	Heavy deficit
	Crease	Slight creases are not controlled; The crease is whitish and has lines, which is not allowed.	Heavy deficit
	Top wound, stab wound	No damage to the line, $D \leq 0.2\text{mm}$; Damage to the line is not allowed.	Heavy deficit
	Scratch	Slight scratches on the surface are not controlled; Damage to the line is not allowed.	Heavy deficit
	Goldfinger scratch	$W \leq 0.05\text{mm}$, no control; $W > 0.05\text{mm}$, not allowed; Test probe tip marks are not controlled.	Heavy deficit
	Component	Under-soldering, over-soldering and false soldering are not allowed.	Heavy deficit

10 Precautions for Use of LCD Modules

10.1 Handling Precautions

10.1.1 The display panel is made of glass. Do not subject it to a mechanical shock by dropping it from a high place, etc.

10.1.2 If the display panel is damaged and the liquid crystal substance inside it leaks out, be sure not to get any in your mouth, if the substance comes into contact with your skin or clothes, promptly wash it off using soap and water.

10.1.3 Do not apply excessive force to the display surface or the adjoining areas since this may cause the color tone to vary.

10.1.4 The polarizer covering the display surface of the LCD module is soft and easily scratched. Handle this polarizer carefully.

10.1.5 If the display surface is contaminated, breathe on the surface and gently wipe it with a soft dry cloth. If still not completely clear, Can only use LCD dedicated cleaner, the following organic solvent can not be used:

- Isopropyl alcohol
- Ethyl alcohol
- Ketone
- Aromatic solvents

10.1.6 Do not attempt to disassemble the LCD Module.

10.1.7 If the logic circuit power is off, do not apply the input signals.

10.1.8 To prevent destruction of the elements by static electricity, be careful to maintain an

10.1.9 optimum work environment.

10.1.9.1 Be sure to ground the body when handling the LCD Modules.

10.1.9.2 Tools required for assembly, such as soldering irons, must be properly ground.

10.1.9.3 To reduce the amount of static electricity generated, do not conduct assembly and other work under dry conditions.

10.1.9.4 The LCD Module is coated with a film to protect the display surface. Be care when peeling off this protective film since static electricity may be generated.

10.2 Storage precautions

10.2.1 When storing the LCD modules, avoid exposure to direct sunlight or to the light of fluorescent lamps.

10.2.2 The LCD modules should be stored under the storage temperature range. If the LCD modules will be stored for a long time, the recommend condition is:

Temperature: 0°C ~ 40°C Relatively humidity: ≤80%.

10.2.3 The LCD modules should be stored in the room without acid, alkali and harmful gas.

10.3 Transportation Precautions

10.3.1 The LCD modules should be no falling and violent shocking during transportation, and also should avoid excessive press, water, damp and sunshine.

11 LCD Introduction

11.1 Process capacity

DWIN adopts original class A glass and the entire production is in the park from cleaning, cutting, bonding, and laminating of large glass to backlight assembly, quality inspection, and aging.

There are 12,000 square meters of clean workshop, with a monthly production capacity of about 2.5 million pieces. Each piece of LCD produced in the factory is for 30 days of aging.



11.2 ODM service

Based on LCD products of 1.5~21.5 inches, DWIN provides the following customization services.

1、LCD HDMI interface customization.

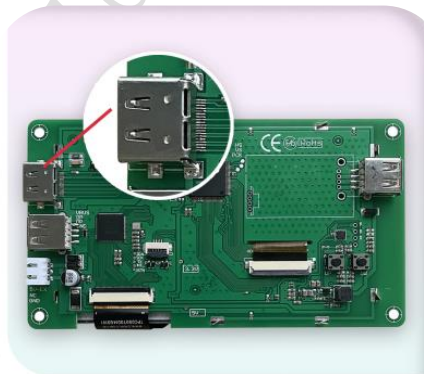

HDMI interface

2、Special screen customization such as high brightness, ultra-wide temperature and strong electromagnetic protection.

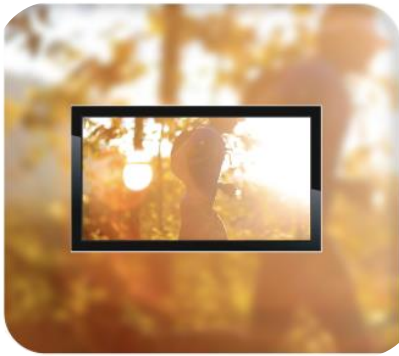

High luminance
(up to 1200nit)



Ultra-wide temperature
(-40~85℃)



Strong electromagnetic
protection

3、Lamination customization service of LCD + TP.



LCM+RTP



LCM+CTP

4、Customization service of DWIN self-developed T5L ASIC+ LCD + TP.



5、Smart screen finished product customization.

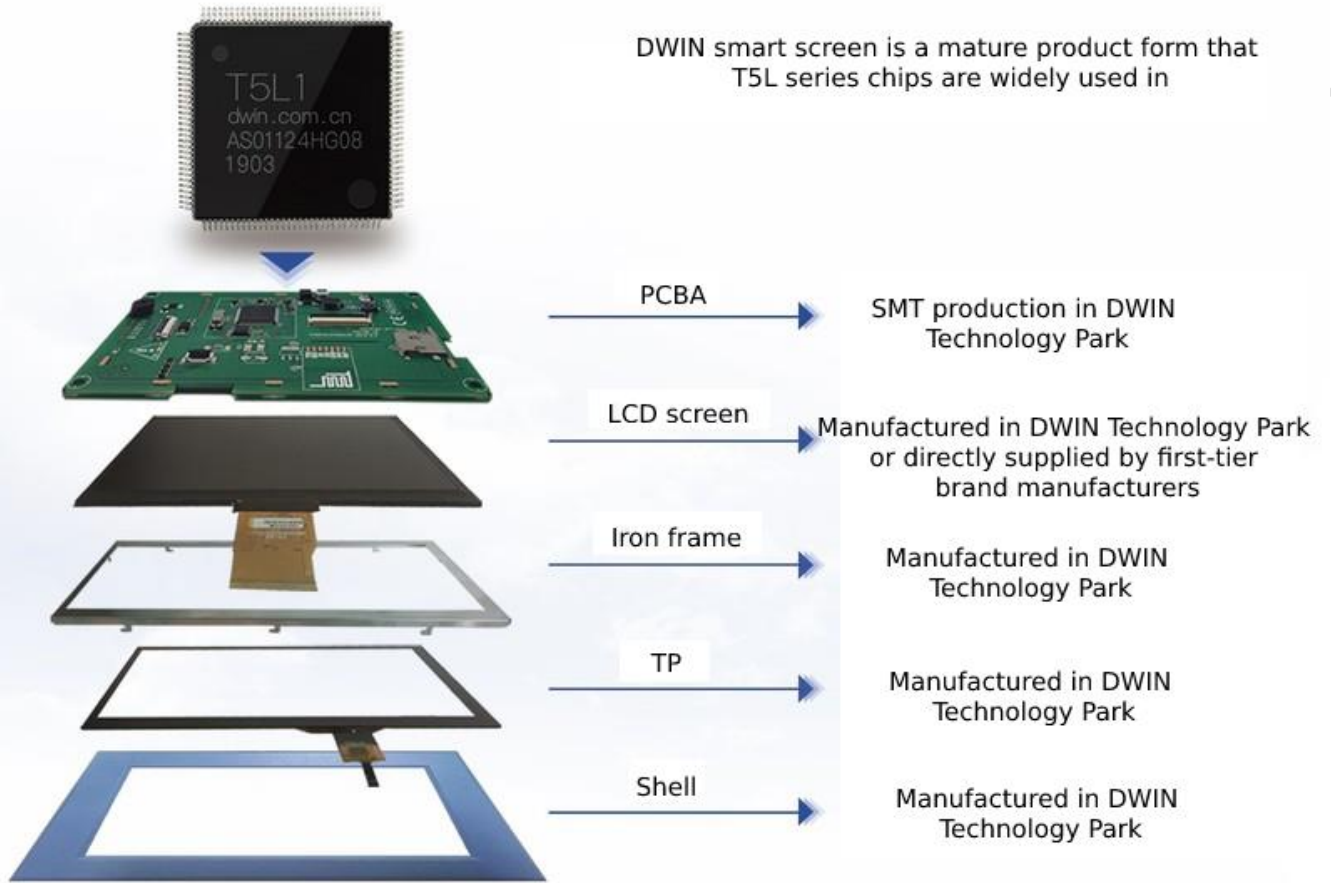

Please contact our sales staff for other customization needs.

Record of Revision

Rev	Date	Description	Editor
00	2022-05-12	First Release	Ouyang Kaixing
01	2022-12-22	Add Product Picture and Driver IC	Chen Xian
02	2023-02-22	Update Packing Capacity	Chen Xian

Please contact us if you have any questions about the use of this document or our products, or if you would like to know the latest information about our products:

Customer service tel: +86 400 018 9008

Customer service email: dwinhmi@dwin.com.cn

DWIN developer forum: <https://forums.dwin-global.com/index.php/forums/>

Thank you all for continuous support of DWIN, and your approval is the driving force of our progress!