

KTA1274 TRANSISTOR (PNP)

FEATURES

- Complementary to KTC3227
- General Purpose Applications

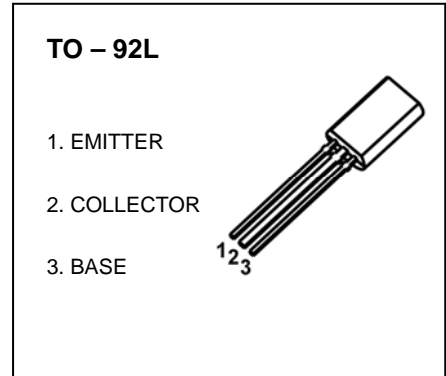

MARKING

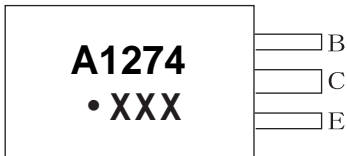

A1274=Device code
 Solid dot = Green molding compound device,
 if none, the normal device
 XXX=Code

Equivalent Circuit

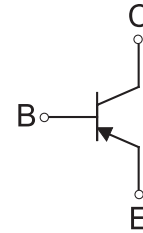

ORDERING INFORMATION

Part Number	Package	Packing Method	Pack Quantity
KTA1274	TO-92L	Bulk	500pcs/Bag
KTA1274-TA	TO-92L	Tape	2000pcs/Box

MAXIMUM RATINGS (T_a=25°C unless otherwise noted)

Symbol	Parameter	Value	Unit
V _{CBO}	Collector-Base Voltage	-80	V
V _{CEO}	Collector-Emitter Voltage	-80	V
V _{EBO}	Emitter-Base Voltage	-5	V
I _C	Collector Current	-0.4	A
P _C	Collector Power Dissipation	0.75	W
R _{θJA}	Thermal Resistance From Junction To Ambient	167	°C/W
T _J , T _{stg}	Operation Junction and Storage Temperature Range	-55~+150	°C

ELECTRICAL CHARACTERISTICS

$T_a=25^\circ\text{C}$ unless otherwise specified

Parameter	Symbol	Test conditions	Min	Typ	Max	Unit
Collector-base breakdown voltage	$V_{(BR)CBO}$	$I_C=-1\text{mA}, I_E=0$	-80			V
Collector-emitter breakdown voltage	$V_{(BR)CEO}$	$I_C=-5\text{mA}, I_B=0$	-80			V
Emitter-base breakdown voltage	$V_{(BR)EBO}$	$I_E=-1\text{mA}, I_C=0$	-5			V
Collector cut-off current	I_{CBO}	$V_{CB}=-50\text{V}, I_E=0$			-0.1	μA
Emitter cut-off current	I_{EBO}	$V_{EB}=-5\text{V}, I_C=0$			-0.1	μA
DC current gain	$h_{FE(1)}$	$V_{CE}=-2\text{V}, I_C=-50\text{mA}$	70		240	
	$h_{FE(2)}$	$V_{CE}=-2\text{V}, I_C=-200\text{mA}$	40			
Collector-emitter saturation voltage	$V_{CE(sat)}$	$I_C=-200\text{mA}, I_B=-20\text{mA}$			-0.4	V
Base-emitter voltage	V_{BE}	$V_{CE}=-2\text{V}, I_C=-5\text{mA}$	-0.55		-0.8	V
Collector output capacitance	C_{ob}	$V_{CB}=-10\text{V}, I_E=0, f=1\text{MHz}$		14		pF
Transition frequency	f_T	$V_{CE}=-10\text{V}, I_C=-10\text{mA}$		100		MHz

CLASSIFICATION OF $h_{FE(1)}$

RANK	O	Y
RANGE	70-140	120-240

Typical Characteristics

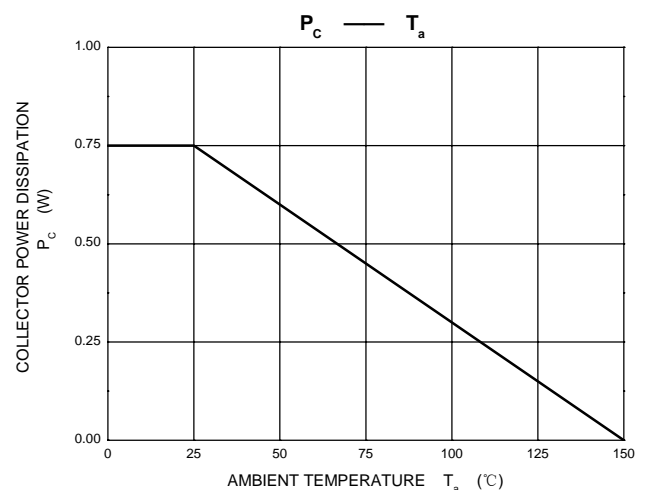
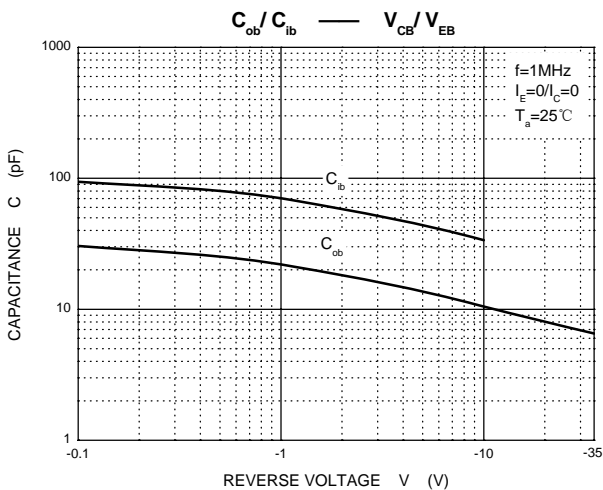
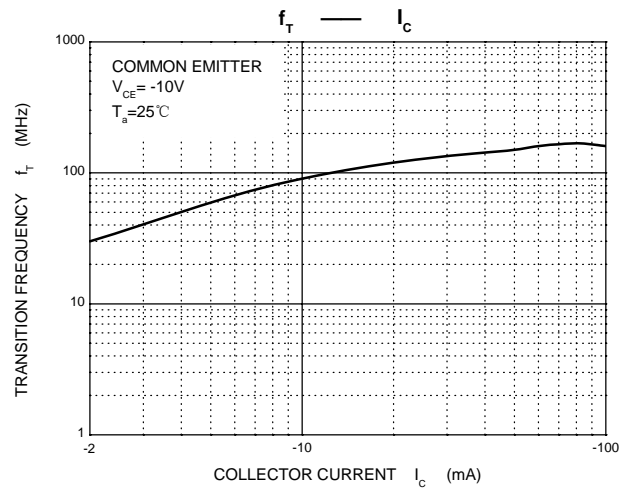
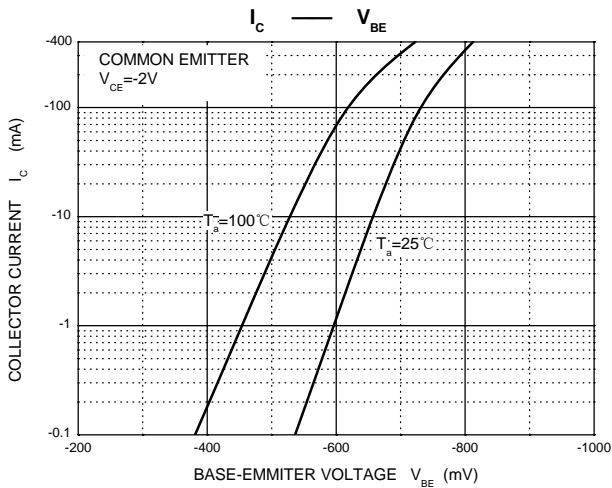
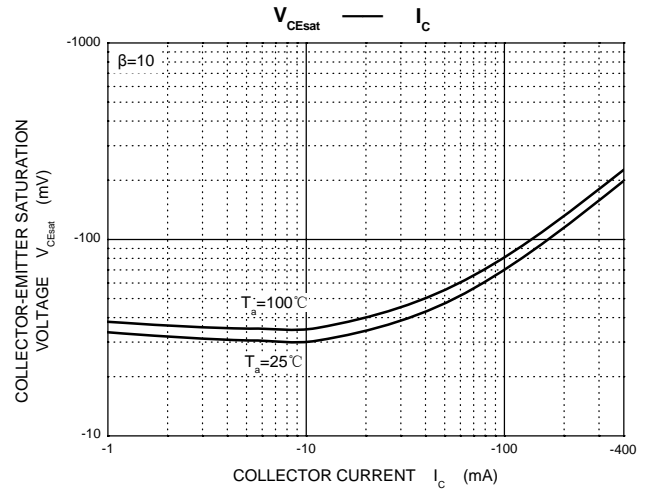
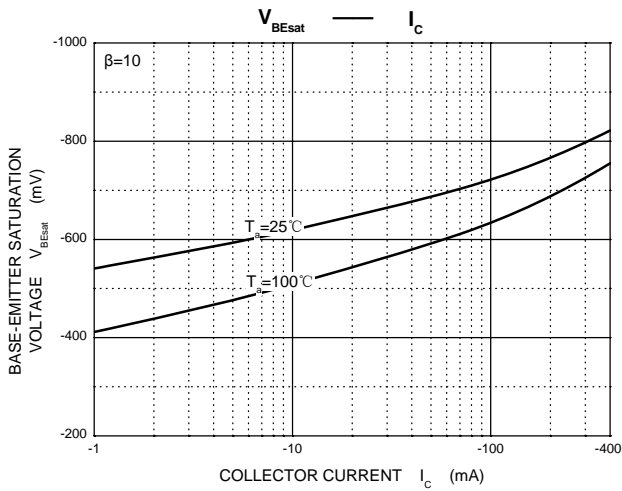
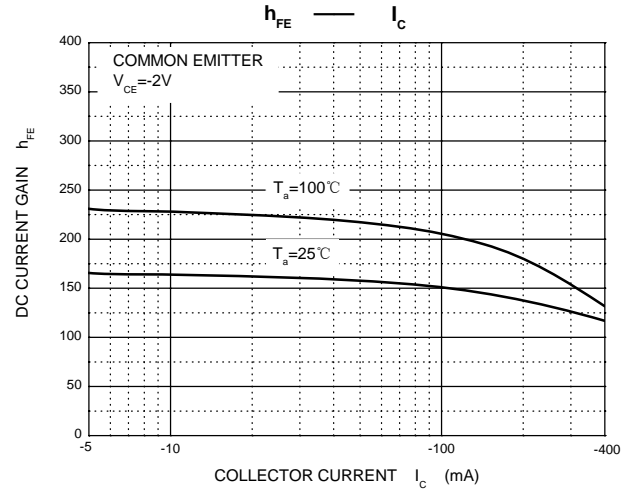
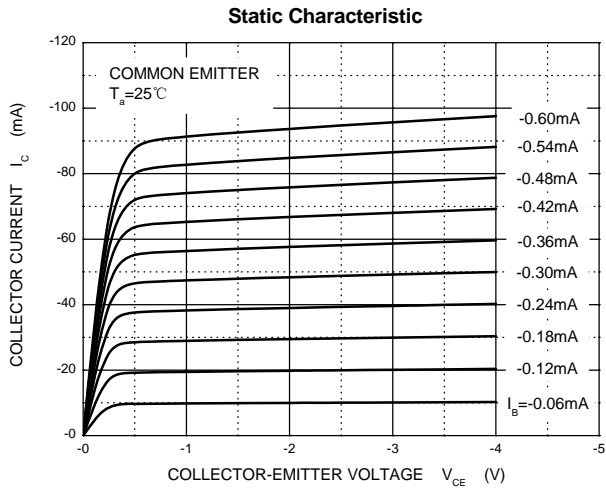

TO-92L Package Outline Dimensions

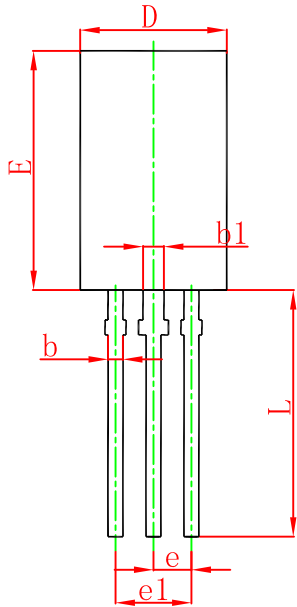
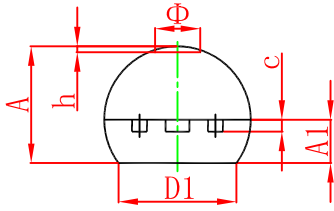

Symbol	Dimensions In Millimeters		Dimensions In Inches	
	Min.	Max.	Min.	Max.
A	3.750	4.050	0.148	0.159
A1	1.280	1.580	0.050	0.062
b	0.380	0.550	0.015	0.022
b1	0.620	0.780	0.024	0.031
c	0.350	0.450	0.014	0.018
D	4.750	5.050	0.187	0.199
D1	4.000		0.157	
E	7.850	8.150	0.309	0.321
e	1.270 TYP.		0.050 TYP.	
e1	2.440	2.640	0.096	0.104
L	13.800	14.200	0.543	0.559
Φ		1.600		0.063
h	0.000	0.300	0.000	0.012

TO-92L Suggested Pad Layout

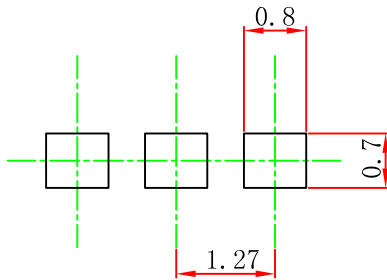

Note:

1. Controlling dimension: in millimeters.
2. General tolerance: $\pm 0.05\text{mm}$.
3. The pad layout is for reference purposes only.

NOTICE

JSCJ reserves the right to make modifications, enhancements, improvements, corrections or other changes without further notice to any product herein. JSCJ does not assume any liability arising out of the application or use of any product described herein.

TO-92L PACKAGE TAPING DIMENSION

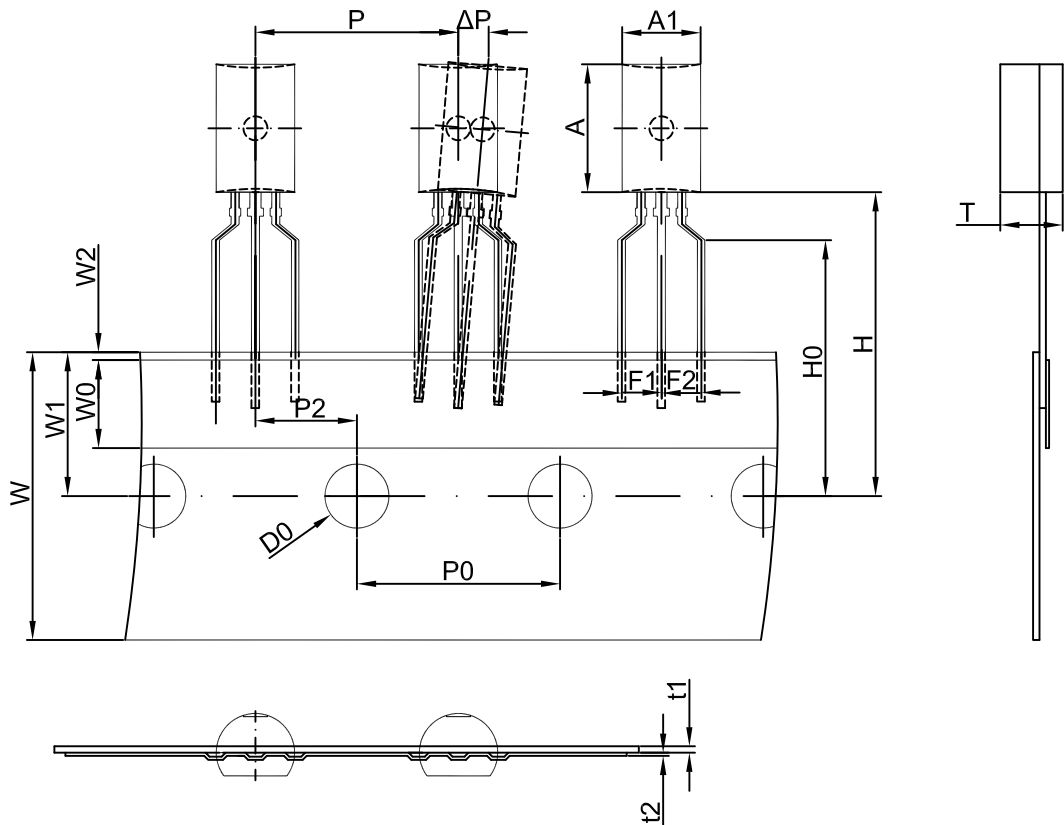

Dimensions are in millimeter

A1	A	T	P	P0	P2	F1	F2	W
4.9	8.0	3.9	12.7	12.7	6.35	2.5	2.5	18.0
W0	W1	W2	H	H0	D0	t1	t2	ΔP
6.0	9.0	1.0	19.0	16.0	4.0	0.4	0.2	0

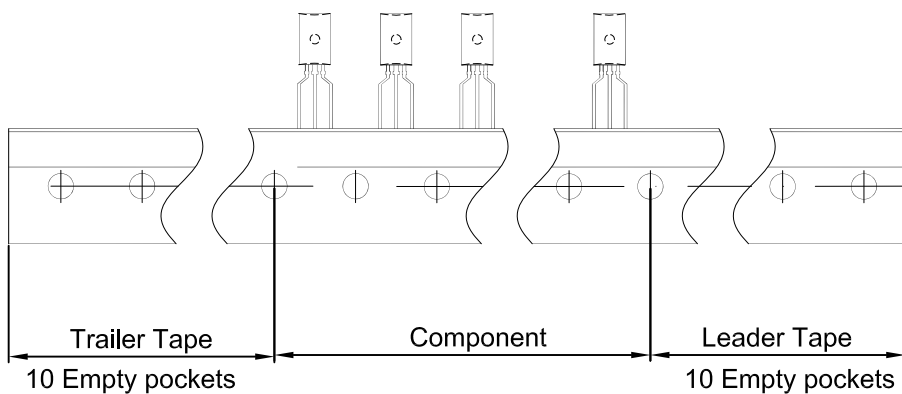

Package	Box	Box Size(mm)	Carton	Carton Size(mm)
TO-92L	2000 pcs	333×203×42	20,000 pcs	493×400×264