

C30 Series AC-DC Converter



Features

- UL, CE Approved
- RoHS directive compliance
- Small, compact size
- High efficiency
- Universal input(AC90~264V or DC120~340V)
- Surface mounting technology
- Built in EMI filter
- Inrush current limit
- 100kHz fixed frequency
- Fixed output voltage
- Thermal shutdown(IC-Temp: 140°C Min.)
- Low output ripple & noise
- Isolated input-output(3kVAC)
- Output short circuit protection
- Over voltage protection(O.V.P.)
- Over current protection(O.C.P.)
- 2Years warranty

Environmental

- Operating temperature range: -10°C~60°C
- Storage temperature range: -20°C~70°C
- Humidity: 20%~90%RH
- Vibration: 10~55Hz at 10G(98m/s²), 3minutes period, 60minutes each one X, Y and Z axis
- Impact: 50G(490m/s²), 11ms, once each
- Cooling method: natural air convection
- MTBF(MIL-HDBK-217F): 2.0*10⁵hours

Safety

- UL (UL60950, CSA C22.2 NO.60950)
- UL No: E227474
- CE(EN60950) – through TÜV

Description

The C30 Series has universal AC input and there are 5 models with single output and 6 models with dual output. High reliability are achieved. A built in EMI filter is reduced the noise level .

C30 Series AC-DC Converter

Electrical specifications		
INPUT	Voltage	AC90~264V (or DC 120~340V) 50/60Hz (note)
	Current	0.89A Maximum
	Frequency	47~440Hz Max. (50~60Hz typ.)
	Efficiency	77% Typ.
	Inrush current (at cold start)	30A Max. @ 120VAC. / 60A Max. @ 240VAC
	Leakage current	0.5mA Max. @ 110VAC / 0.75mA Max. @ 220VAC
OUTPUT	Voltage adj. Range	±10% typical @Output1
	Ripple and noise	1% maximum
	Line regulation	±1% maximum
	Load regulation	±1% maximum @Output1 / ±2%maximum @Output2
	Dynamic load regulation	±3% maximum @Output1
	Temperature regulation	±1% Typical
	Rising time	100ms Maximum
	Hold up time	17ms Minimum
	Minimum load	Output1 current > Output2 current(dual)

Protection circuit	
Over current protection	Works at over 105% of rating & recovers automatically
Over voltage protection	115~140% of rating
Over temperature protection	80°C Minimum (Latch-up mode)

Isolation specifications	
Isolation Resistance	DC 500V, 70MOhms Min.
Input-Output Isolation Voltage	AC 3KV, 1minute, 10mA.
Input-FG	AC 2KV, 1minute, 10mA.
Output-FG	AC 0.5KV, 1minute, 10mA.

General specifications	
Switching frequency	100kHz
Calculated MTBF	2.0*10 ⁵ hours
Weight	270g or less(single), 370g or less(dual)

NOTE: For cases that conform various safety specifications(UL, CSA, CE etc). It require input voltage and frequency range will be 100~240Vac, 50~60Hz.

C30 Series AC-DC Converter

Ordering information

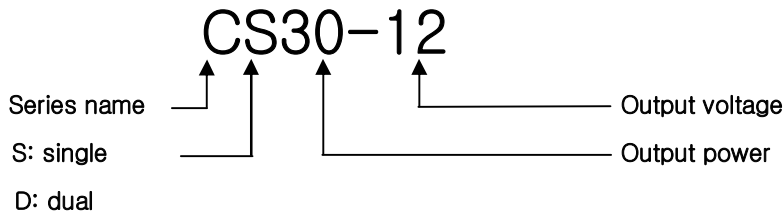

Input	Output1	Output2	Maximum power	Ripple & Noise	Efficiency typical	Model number
AC90~264V	+3.3V@6.0A		19.80W	30mVp-p	72%	CS30-3R3
	+5V@6.0A		30.00W	50mVp-p	73%	CS30-5
	+12V@2.5A		30.00W	100mVp-p	75%	CS30-12
	+15V@2.0A		30.00W	120mVp-p	78%	CS30-15
	24V@1.5A		36.00W	150mVp-p	79%	CS30-24
DC120~340V	+5V@3.0A	+5V@3.0A	30.0W	50/50mVp-p	75%	CD30-55
	+5V@3.0A	+12V@1.2A	29.4W	50/120mVp-p	77%	CD30-52
	+5V@3.0A	+15V@1.0A	30.0W	50/150mVp-p	77%	CD30-5F
	+5V@3.0A	+24V@0.6A	29.4W	50/200mVp-p	78%	CD30-54
	+12V@1.2A	+12V@1.2A	28.8W	120/120mVp-p	78%	CD30-1212
	+15V@1.0A	+15V@1.0A	30.0W	150/150mVp-p	78%	CD30-1515

Pin assignments

Single output	Dual output	Connector
1. AC(L)	1. AC(L)	CN1
2. AC(N)	2. AC(N)	
3. F.G.	3. F.G.	
4. -V	4. -V2	
5. +V	5. +V2	
	6. -V1	
	7. +V1	

Derating curve

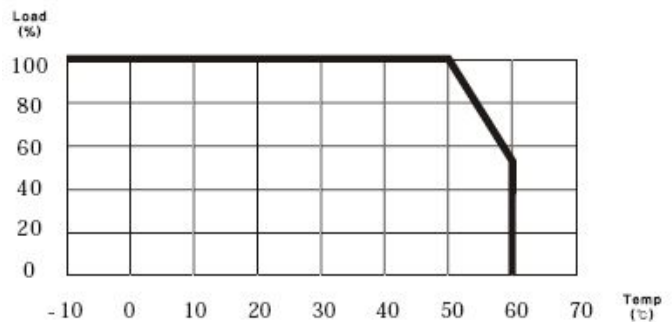

C30 Series AC-DC Converter

Dimensions

► Single Output

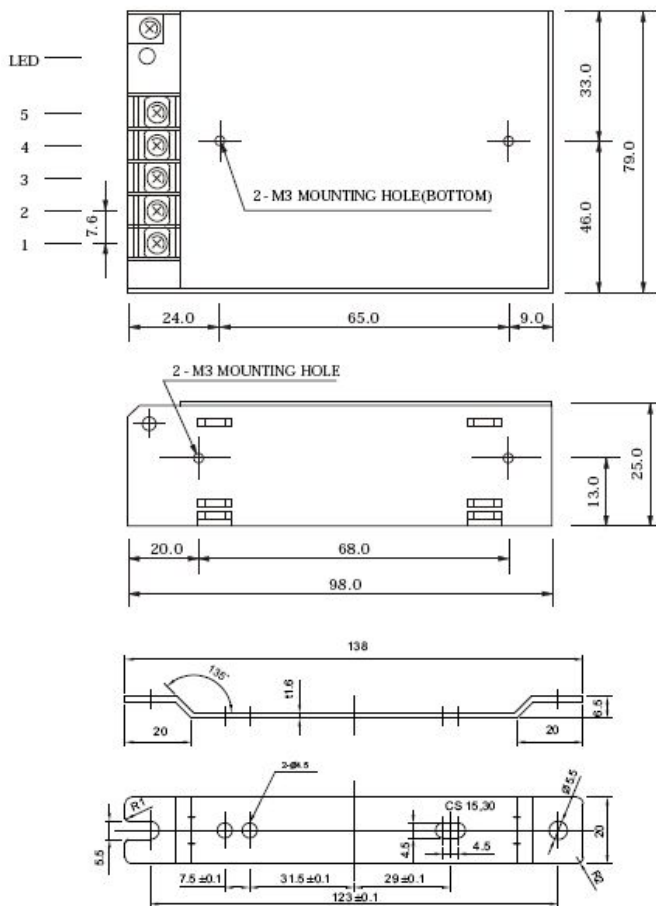

► Dual Output

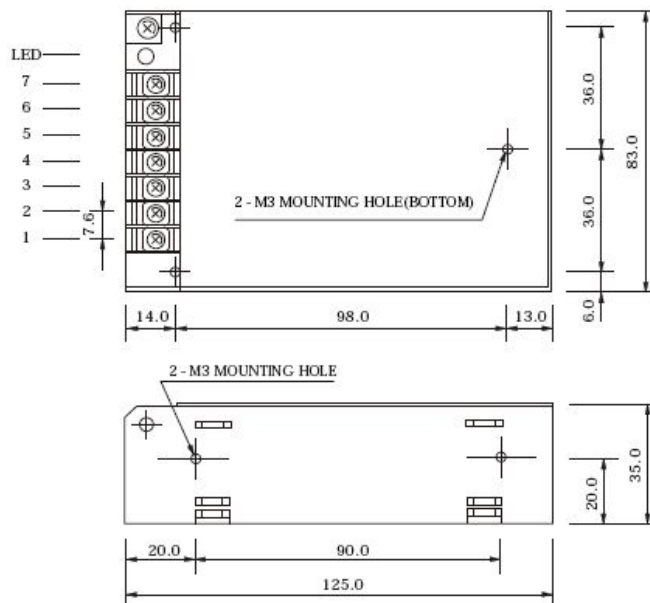

NOTES

1. All dimensions are mm.
2. Weight : 270g or less (single)
370g or less(Dual)
3. Mounting holes(5) for M3 screw, which should not enter the supply surface by more than 2.5mm.

C30 Series AC-DC Converter

Inrush Current

TEST CONDITION

- 240Vac input
- Full load output
- Phase 90° input start, current measure

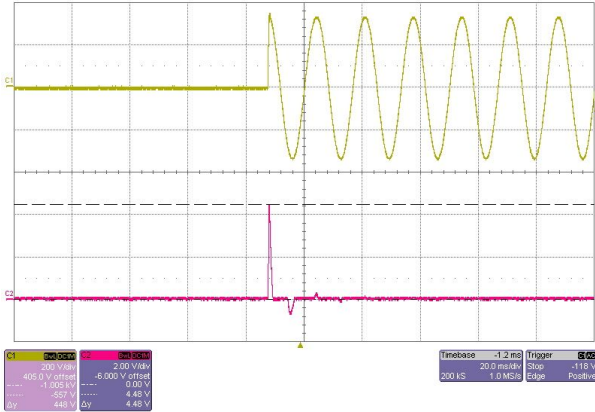

CS30-3R3 22.4A

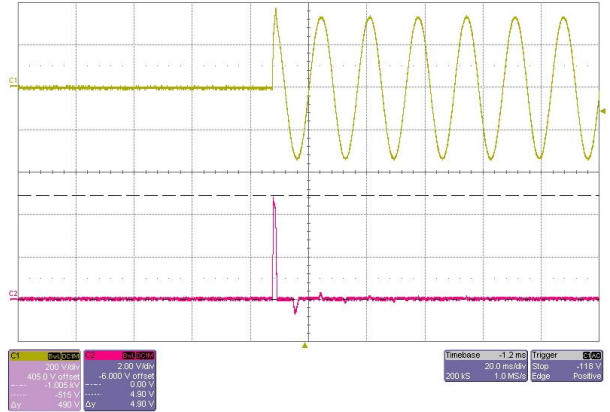

CS30-5 24.5A

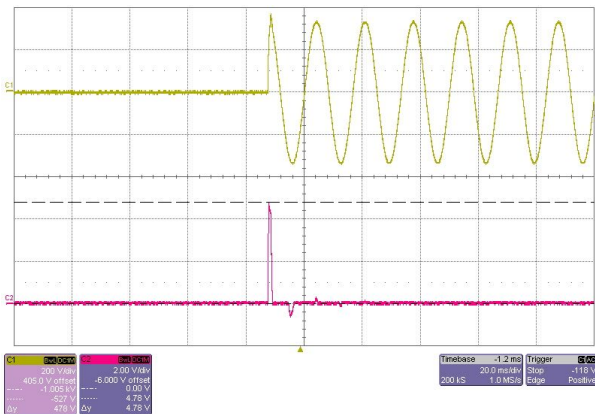

CS30-12 23.9A

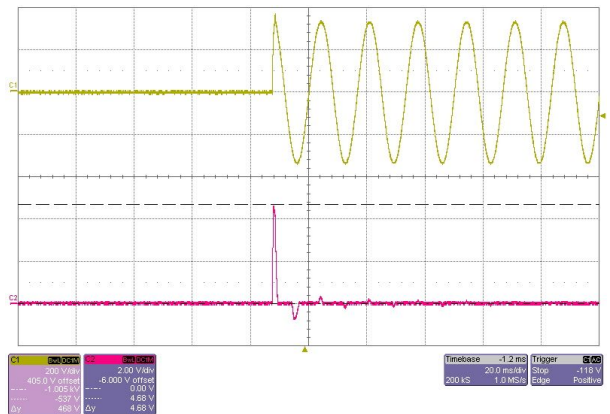

CS30-15 23.4A

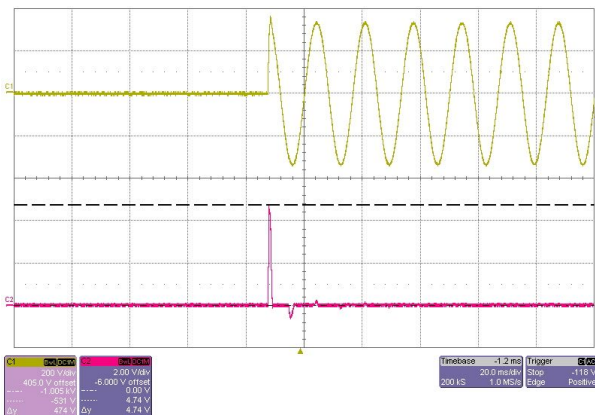

CS30-24 23.7A

Inrush current concerns wrong to fuse, input rectifier, power-switch, circuit break and parts.

It degrades the another circuit voltage and occurs system error. If you defuse inrush current.

You add NTC or Inrush current limiter to external circuit. High rating voltage input

Max30A @ 120Vac

Max60A @ 240Vac

C30 Series AC-DC Converter

Rising Time

TEST CONDITION

- 100Vac Input
- Full Load Output
- Output Voltage 10% ~ 90% Rising Time Measure

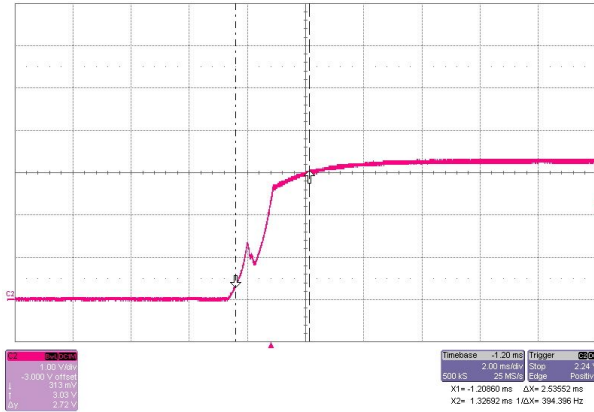

CS30-3R3 2.5mS

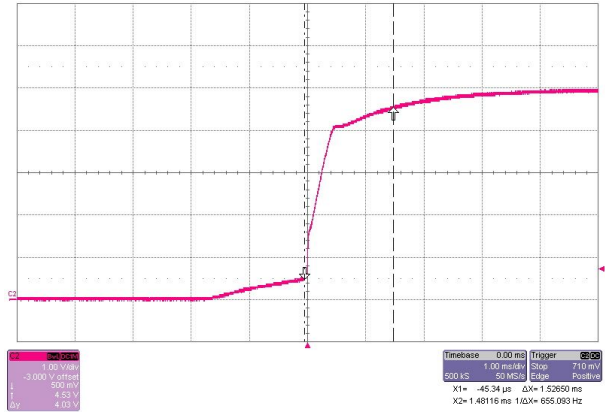

CS30-5 1.5mS

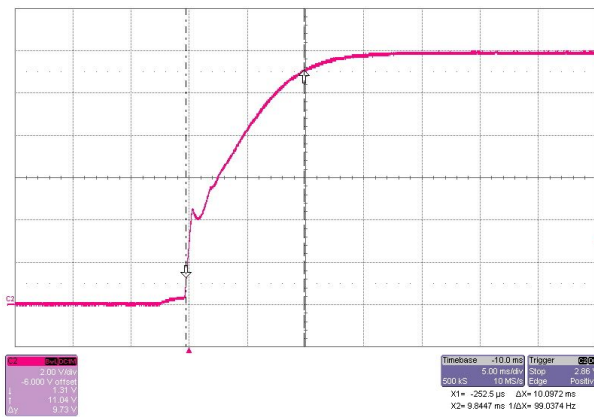

CS30-12 10.1mS

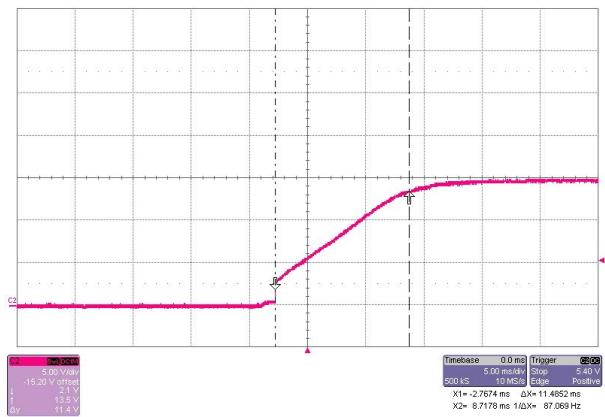

CS30-15 11.5mS

Max 100ms between output voltage 10%~90%

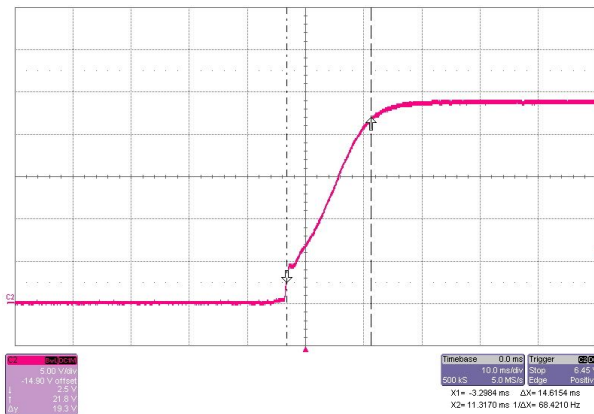

CS30-24 14.6mS

C30 Series AC-DC Converter

Hold up Time

TEST CONDITION

- 100Vac Input
- Full Load Output
- When Input off Phase 0° or 360°, Output Voltage off Time Measure

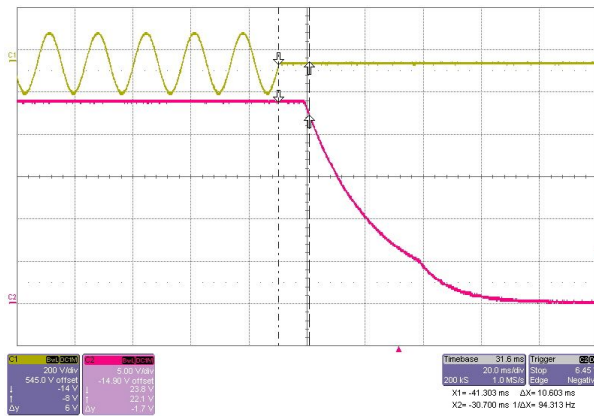
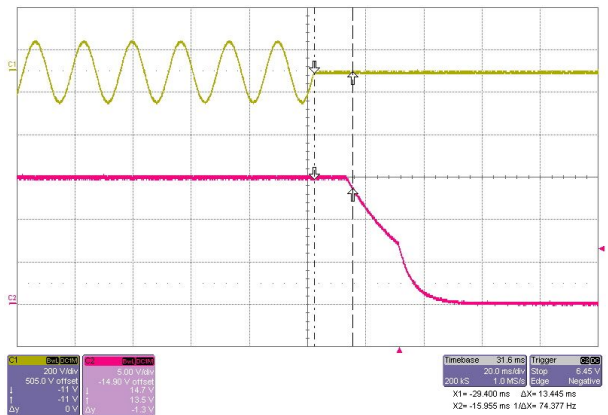
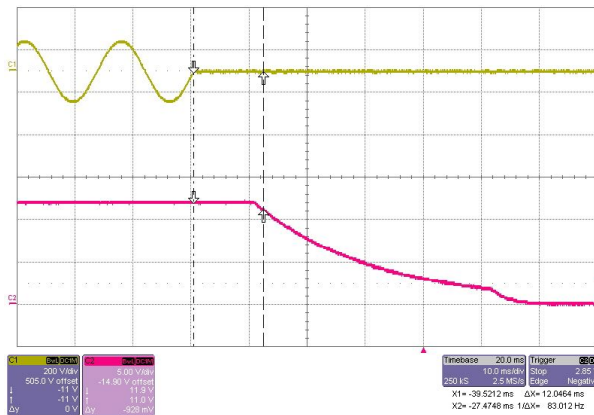
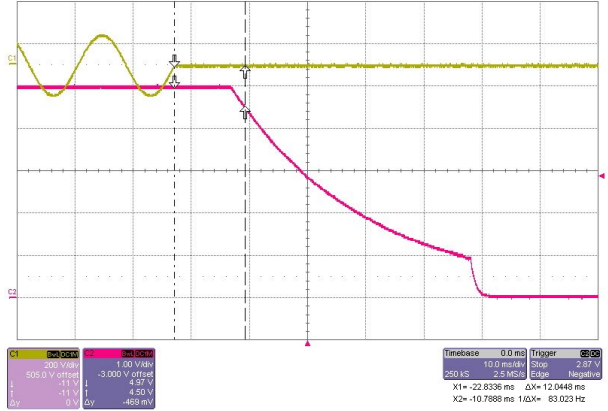
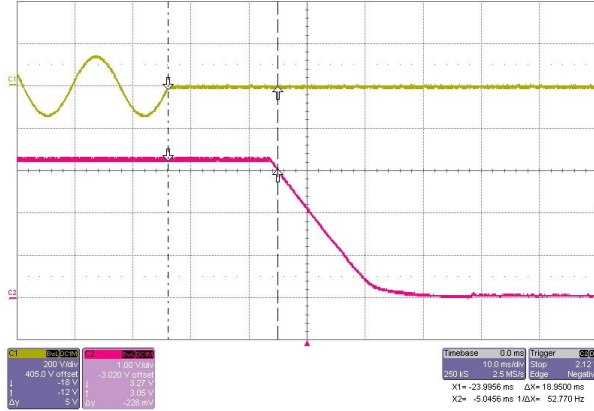

The amount of time that a power supply's output-voltage remains within the specified-voltage ranges after it's input voltage interrupts. Low rating voltage Minimum 10ms @100Vac input

C30 Series AC-DC Converter

Start up Time

TEST CONDITION

- 100Vac Input
- Full Load Output
- When Input on Phase 360°, Output Voltage 100% rise Time Measure

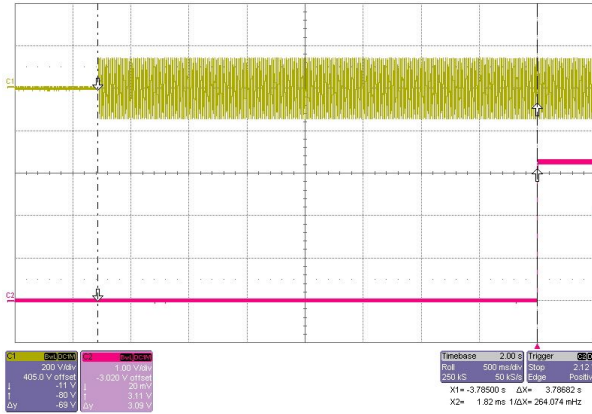

CS30-3R3 3.8S

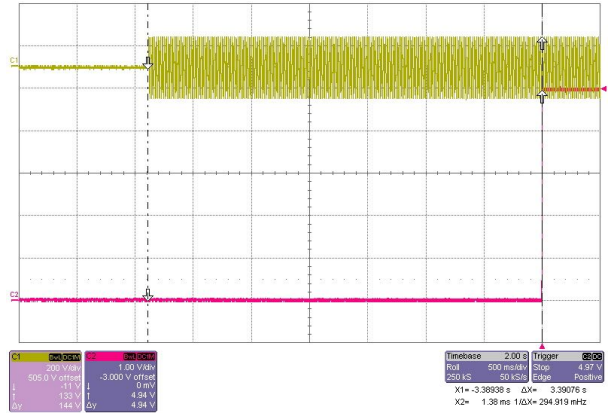

CS30-5 3.4S

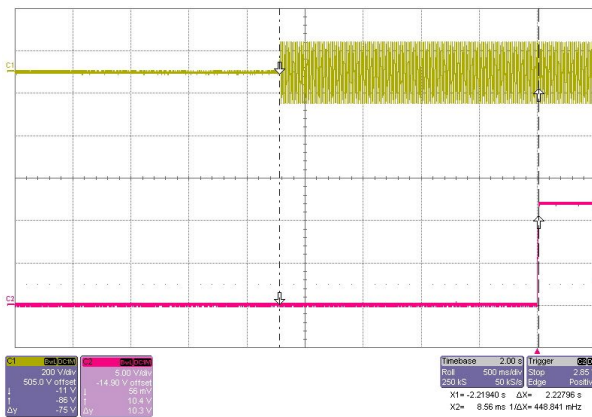

CS30-12 2.2S

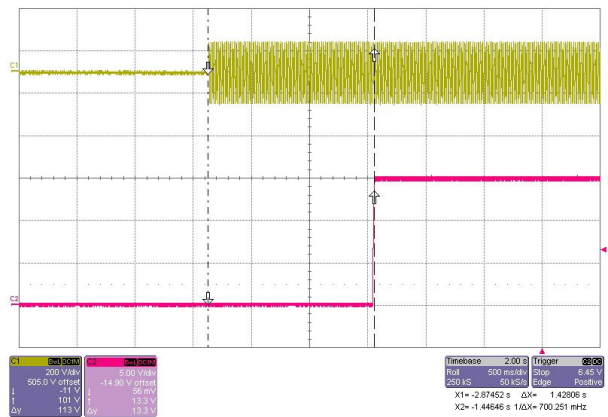

CS30-15 1.4S

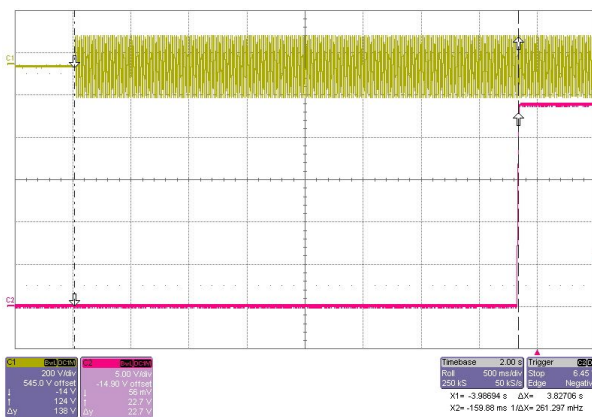

CS30-24 3.8S

Amount of delay time and rise time. After input-voltage injects.

C30 Series AC-DC Converter

Over Shoot

TEST CONDITION

- 240Vac Input
- Full Load Output

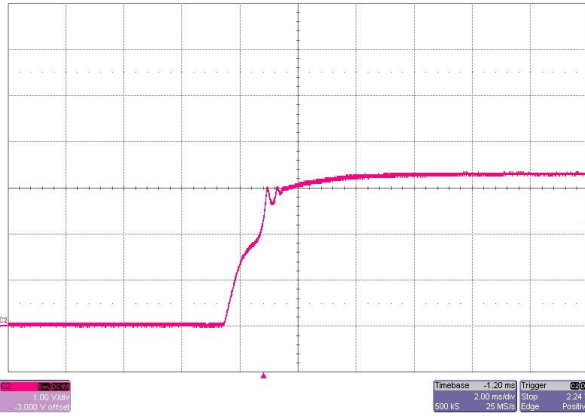

CS30-3R3 0V

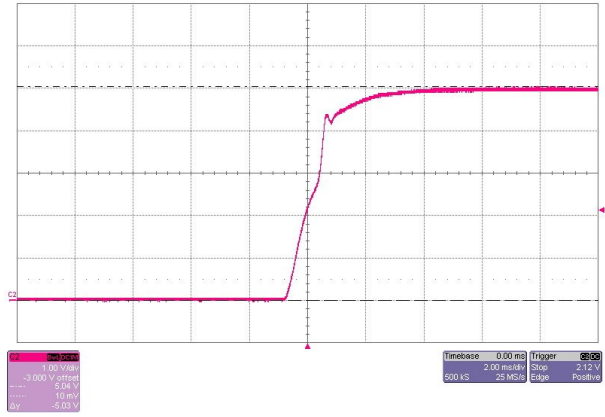

CS30-5 0V

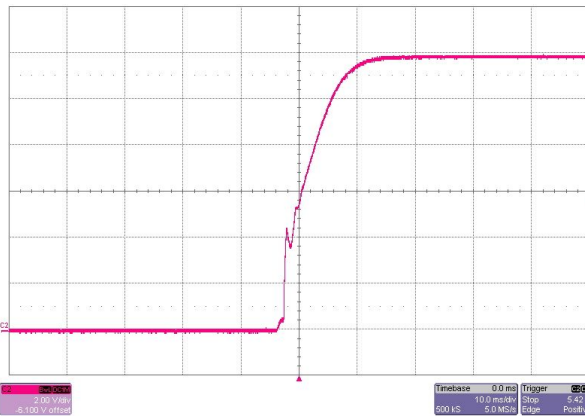

CS30-12 0V

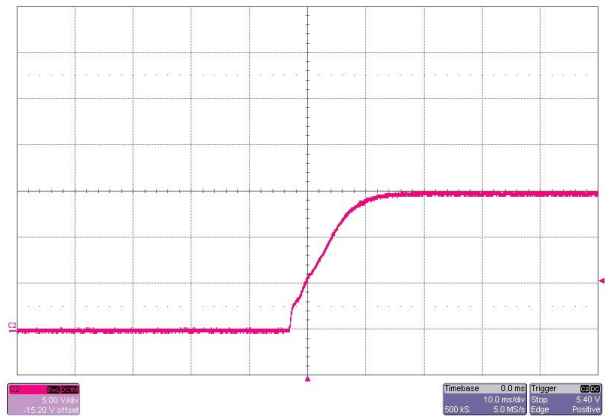

CS30-15 0V

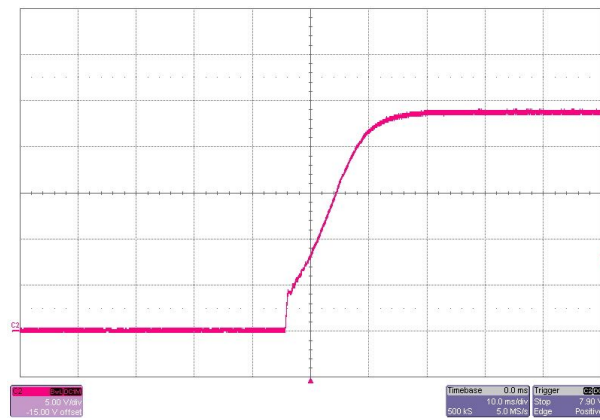

CS30-24 0V

When turn-on, the output overshoot voltage shall not exceed 5% of normal Voltage value no Load or full Load connected.

C30 Series AC-DC Converter

Output Ripple & Noise

TEST CONDITION

- 100Vac Input
- Full Load Output
- Ele-cap(47uF)and Ceramic-cap(104), Output Terminal

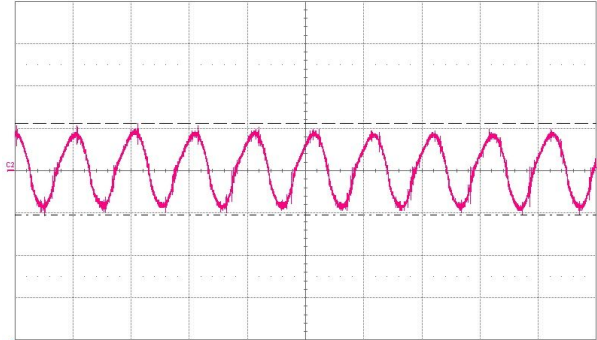

CS30-3R3 43.2mVpp

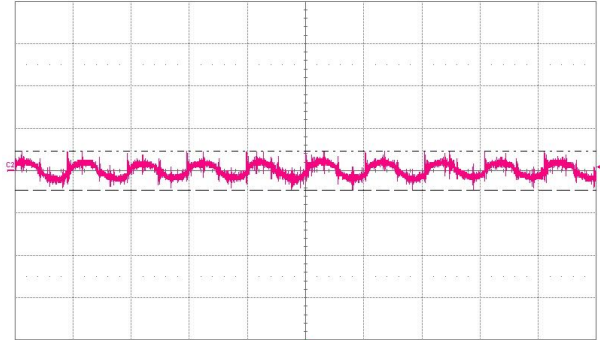

CS30-5 18.8mVpp

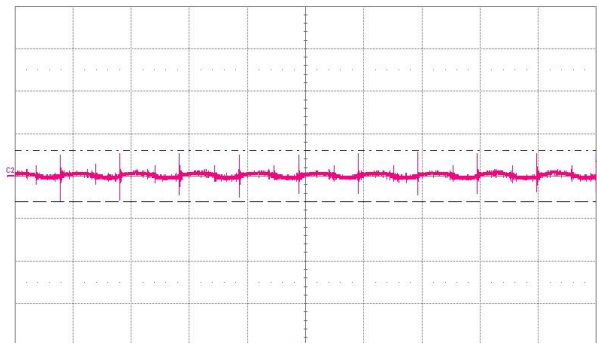

CS30-12 60.5mVpp

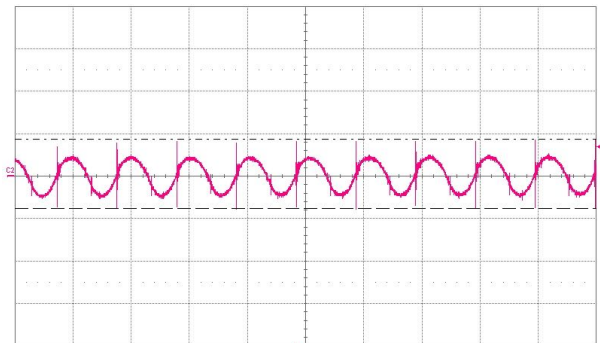

CS30-15 81.5mVpp

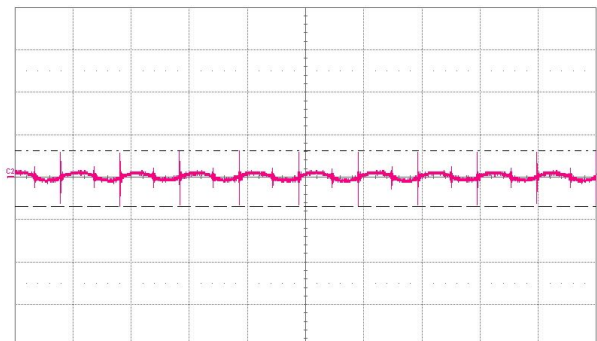

CS30-24 66.0mVpp

*Ripple & Noise: Oscilloscope bandwidth 20MHz.

The length of the output line should be shorter than 1meter and it needs to be twisted.

C30 Series AC-DC Converter

Efficiency Curve(Load Variation)

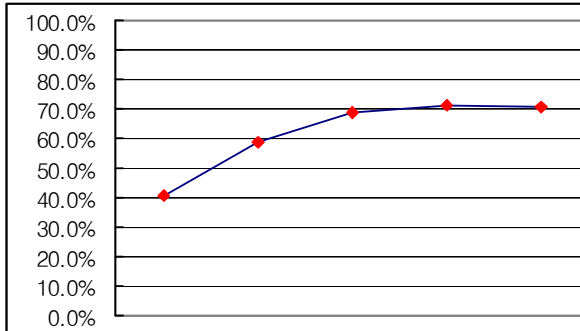

Load(%)	10	25	50	75	100
Eff(%)	40.8	59.0	68.7	71.0	70.6

CS30-3R3 / 3.3V 6.0A

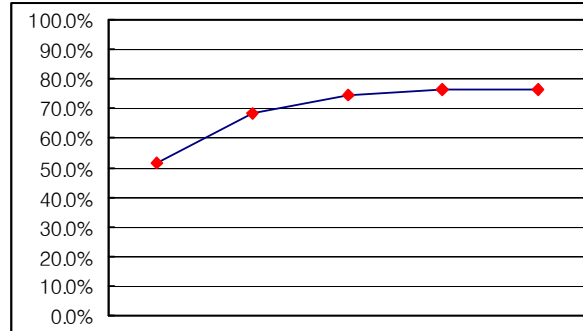

Load(%)	10	25	50	75	100
Eff(%)	51.8	68.6	74.4	76.5	76.4

CS30-5 / 5V 6.0A

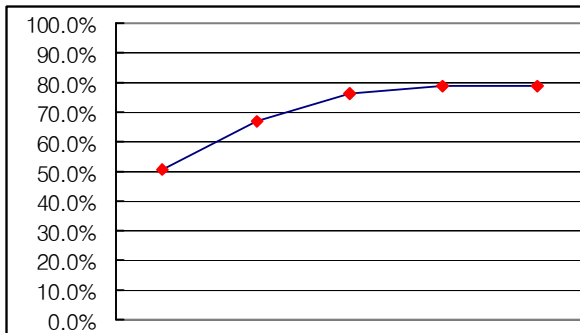

Load(%)	10	25	50	75	100
Eff(%)	50.5	67.1	75.9	79.0	78.6

CS30-12 / 12V 2.5A

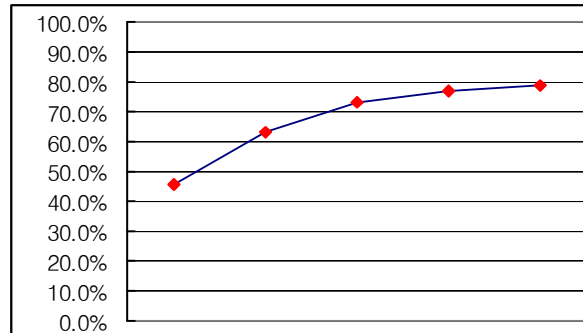

Load(%)	10	25	50	75	100
Eff(%)	45.4	63.3	73.3	76.7	79.0

CS30-15 / 15V 2.0A

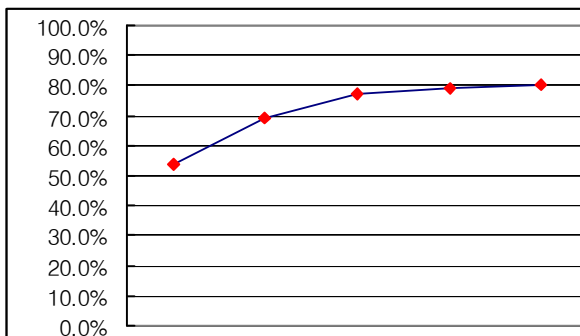

Load(%)	10	25	50	75	100
Eff(%)	53.5	68.9	77.2	79.0	80.5

CS30-24 / 24V 1.5A

Input 220Vac, Variation of efficiency, from minimum load to maximum load.

C30 Series AC-DC Converter

Efficiency Curve(Input Voltage Variation)

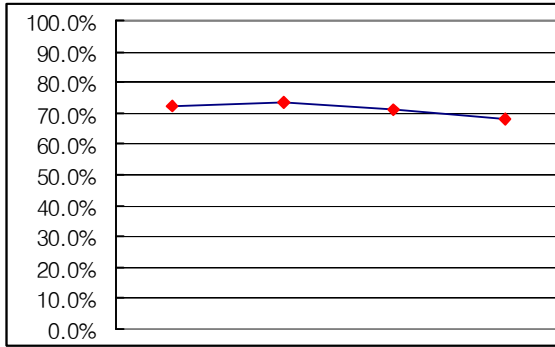

V in(V)	90	110	220	264
Eff(%)	72.3	73.5	70.9	68.2

CS30-3R3 / 3.3V 6.0A

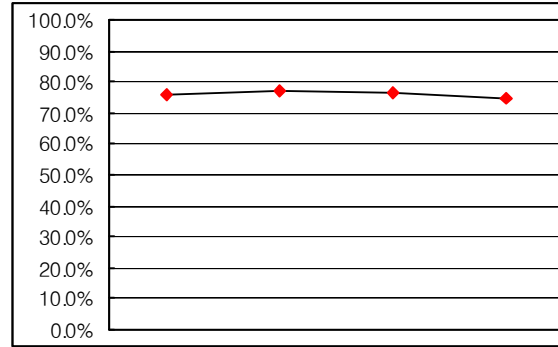

V in(V)	90	110	220	264
Eff(%)	75.9	77.2	76.4	74.6

CS30-5 / 5V 6.0A

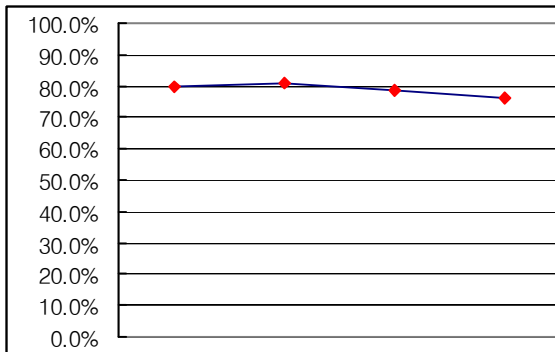

V in(V)	90	110	220	264
Eff(%)	79.8	80.8	78.5	76.3

CS30-12 / 12V 2.5A

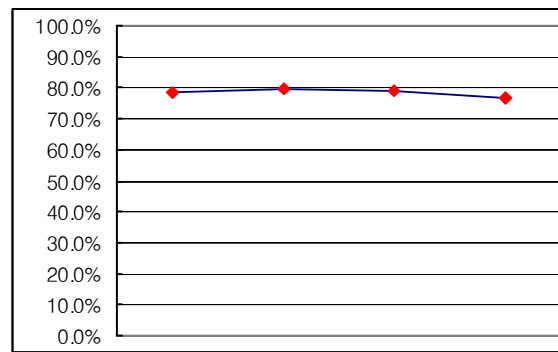

V in(V)	90	110	220	264
Eff(%)	78.2	79.8	78.8	76.8

CS30-15 / 15V 2.0A

Variation of Efficiency, from Minimum input
Voltage to Maximum input Voltage

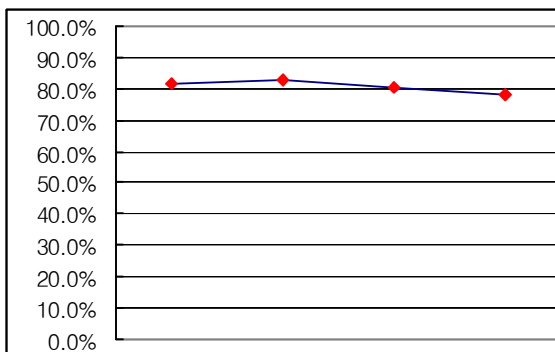

V in(V)	90	110	220	264
Eff(%)	81.8	82.7	80.5	78.3

CS30-24 / 24V 1.5A

C30 Series AC-DC Converter

Electro Magnetic Interference Application.

C30 Series is needs to reduce Electromagnetic Interference, use the external L-C noise filter at the input of the Converter.

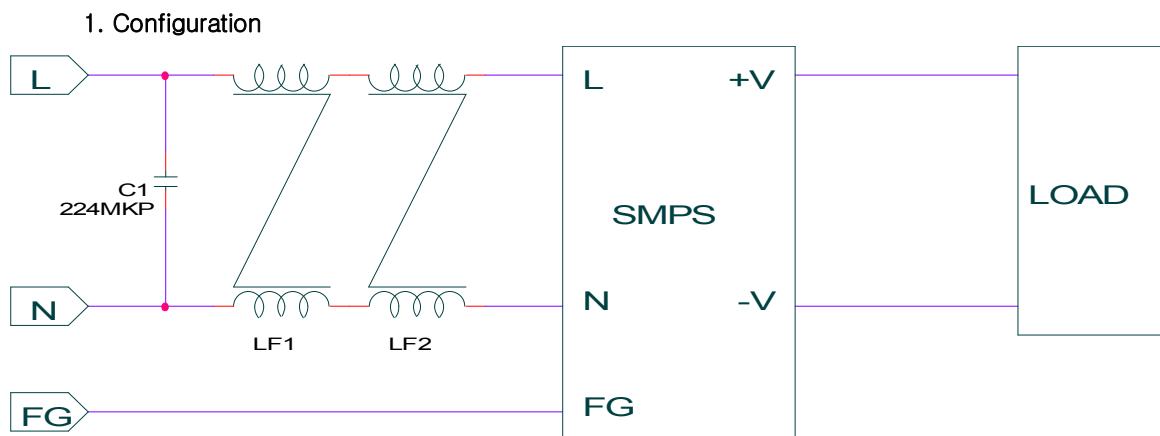

2. Components

C1 = 220nF / 275Vac, X2 Capacitor

LF1 = 20mH Common Mode Line Filter, Toroidal core ϕ 14.0mm

LF2 = 20mH Common Mode Line Filter, Toroidal core ϕ 14.0mm

C30 Series AC-DC Converter

Calculating Reliable Values of MTBF

1. Calculating method

Calculated based on part count reliability projection of MIL-HDBK-217F Individual failure rates λ_g is given to each part and MTBF (Mean Time Between Failure) is calculated by the count of each part.

<Formula>:

$$MTBF = 1 / \lambda_{equip} = 1 / \left(\sum_{i=1}^n N_i (\lambda_G \Pi Q)_i \right) * 10^6 \text{ (Hours)}$$

λ_{equip} : Total Equipment Failure Rate (Failure/10⁶Hours)

λ_G : Generic Failure Rate for The ith Generic Part (Failure/ 10⁶Hours)

ΠQ : Generic Quality Factor for The ith Generic Part ($\Pi Q=1$)

N_i : Quantity of ith Generic Part

n : Number of Different Generic Part Categories

2. MTBF Values

MTBF \approx 205,809(Hours)

PART	Num.	Failure Rate	Failure Rate*n	Remark
	n	$\lambda_G(F/T)$	$\lambda_G \times n(F/T)$	
Logic IC	1	0.06000	0.06000	101~1000gate
Transistor, FET	1	0.49500	0.49500	IC Separate
Voltage Regulator(TL431)	1	0.02400	0.02400	
Photo-coupler(SCR)	2	0.14850	0.29700	
Varistor	1	0.01595	0.01595	
Thermister	1	0.01400	0.01400	
Resistor Wirewound, Accurate	1	0.02400	0.02400	
Resistor Volume	1	0.02400	0.02400	
Resistor Chip	21	0.01600	0.33600	
Capacitor-ele	6	0.01900	0.11400	
Capacitor-film, MF	3	0.00700	0.02100	
Capacitor-ceramic	4	0.02600	0.10400	
Capacitor-MLCC	7	0.05300	0.37100	
Diode Fast Recovery, Power	3	0.12650	0.37950	
Diode Switching	1	0.00517	0.00517	
Diode Zener (and Avalanche)	5	0.01815	0.09075	
Diode LED	1	0.00259	0.00259	
Diode Bridge	1	0.12650	0.50600	*4
Inductor or Choke	3	0.00010	0.00029	
Transformer, Power	1	0.15900	0.15900	
Line Filter	1	0.00440	0.00440	
Terminal block	1	0.06200	0.31000	*5(pin)
Reflow soldering	73	0.00014	0.01022	
Flow soldering	95	0.00780	0.74100	
PCB	1	0.37000	0.74000	*2
Fuse	1	0.01000	0.01000	
Total Equipment Failure Rate $\lambda_G \times n(F/T)$			4.858863	
MTBF = $10^6 / \lambda_G(F/T)$			205809.4661	

C30 Series AC-DC Converter

Reliability Specification	Standard	Remarks
Dry heat	IEC60068-2-2	
Cold	IEC60068-2-1	
Thermal shock	IEC60068-2-14	
Temperature, humidity cycle	IEC60068-2-30, IEC60068-2-38	
Vibration	IEC 60068-2-6	
Mechanical shock	IEC 60068-2-27	
Electrostatic Discharge immunity	IEC 61000-4-2	
Immunity to radio frequency EM-fields	IEC 61000-4-3	
Electrical fast transient/burst immunity	IEC 61000-4-4	
Surge immunity	IEC 61000-4-5	
B10 Life test	B10 Life is the time by which 10% of the product population will get failed	

C30 Series AC-DC Converter

Instruction manual

1. Basic connection

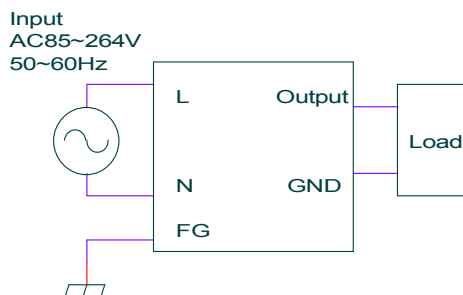

NOTE:

A: For safety as well as improved noise, ensure secure connection of the FG terminal to the ground terminal of the equipment.

B: To avoid excessive voltage drop and for improved noise, and short and thick wire should be used to connect the load. Length below 50Cm & wire thickness of 4.0A/mm² are recommended for reducing wire loss when wire connection is necessary.

2. Parallel Operation

This supply can be operated the following ways.

Choose a diode in accordance with voltage, power dissipation and heat radiation.

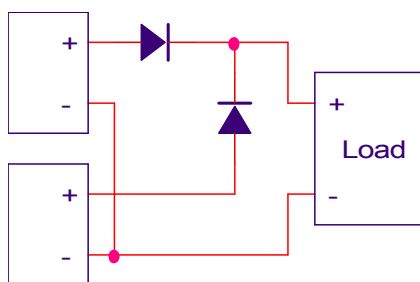

- Voltage : $V > V_o \times 3$
- Current : $I > I_o \times 3$
- Design a proper heat sink according to power loss at diode ($P_w = VF \times I_o$)

- Use a schottky or fast recovery diode this has a low VF.

3. Series Operation

Choose a diode in accordance with voltage, power dissipation and heat radiation.

- Voltage : $V > V_o \times 3$
- Current : $I > I_o \times 3$
- Design a proper heat sink according to power loss at diode ($P_w = Vf \times I_o$).
- Use a schottky or fast recovery diode this has a low VF.

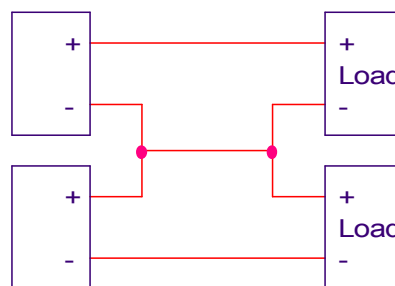
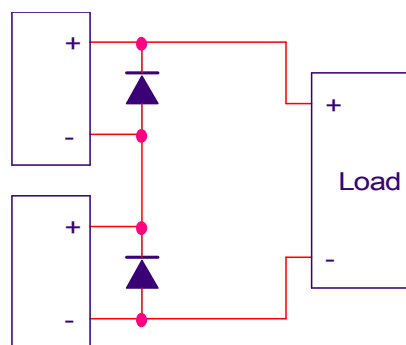

4. Over Current Protection

The C30 Series is equipped with an over current protection circuit. When the short or overload condition is removed, the output will automatically recover.

This setting is fixed and cannot be varied externally. If the short or overload condition continues, the power module could be damaged due to the heat condition.

C30 Series AC-DC Converter

5. Over Voltage Protection

C30 series are equipped with an over-voltage protection circuit by zener diode. If zener diode is opened, Vcc rise up, it becomes possible to implement an over voltage protection. Latch on mode. If zener diode is short, output is shorted.

It becomes possible to implement a short circuit Protection.

6. Over Temperature Protection

Temperature protection is provided by a precision analog circuit that turns the output MOSFET off when the junction temperature exceeds the thermal shutdown temperature (140°C Minimum). When the junction temperature cools to below the hysteretic temperature, normal operation resumes providing automatic recovery.

7. Line Regulation

Maximum line regulation is maximum output voltage change when the input volt is slowly varied with in the input voltage range.

8. Load Regulation

Maximum load regulation is maximum output voltage value change when varying the load current slowly within the standard output current range.

9. Isolation Resistance

The isolation resistance is more than 100MΩ at 500VDC when tested with DC isolation between the output and the case. Make sure that during testing, the isolation tester does not produce a high pulse when the applied voltage is varied. Ensure that the tester is fully discharged after the test.

10. Withstand Voltage

C30 series are designed to withstand 3KVAC (10mA) 1 minute between input output for the withstand voltage test, 2KVAC(10mA) 1minute between input-FG , and 500VAC(10mA)1 minute between output-FG. The applied voltage must be increased gradually from zero to the testing value, and then decreased gradually at shut down.

Especially stay away from use of a timer. Where a pulse of several times the applied voltage can be generated.

INPUT-OUTPUT

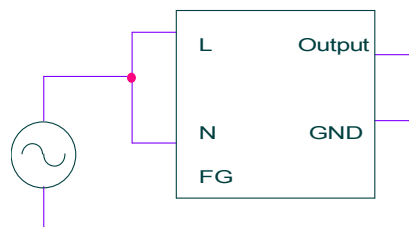

3KVAC, one minute, 10mA

INPUT-FG

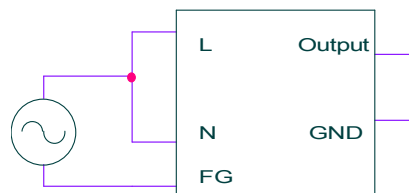

2KVAC, one minute, 10mA

OUTPUT-FG

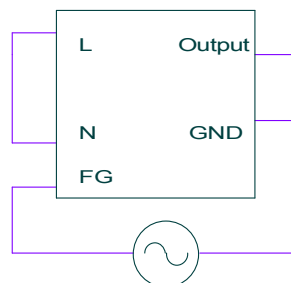

500VAC, one minute, 10mA

C30 Series AC-DC Converter

11. Fuse rating

Rating: 250V 3.15A

Type: Time-Lag

UL/CSA or IEC approved type should be used to meet safety requirements. When changing fuse ensure that the same type and ratings used. Avoid using fast-blow fuse.

12. Block Diagrams

Circuit topology : Forward

Switching frequency : 100KHz(fixed)

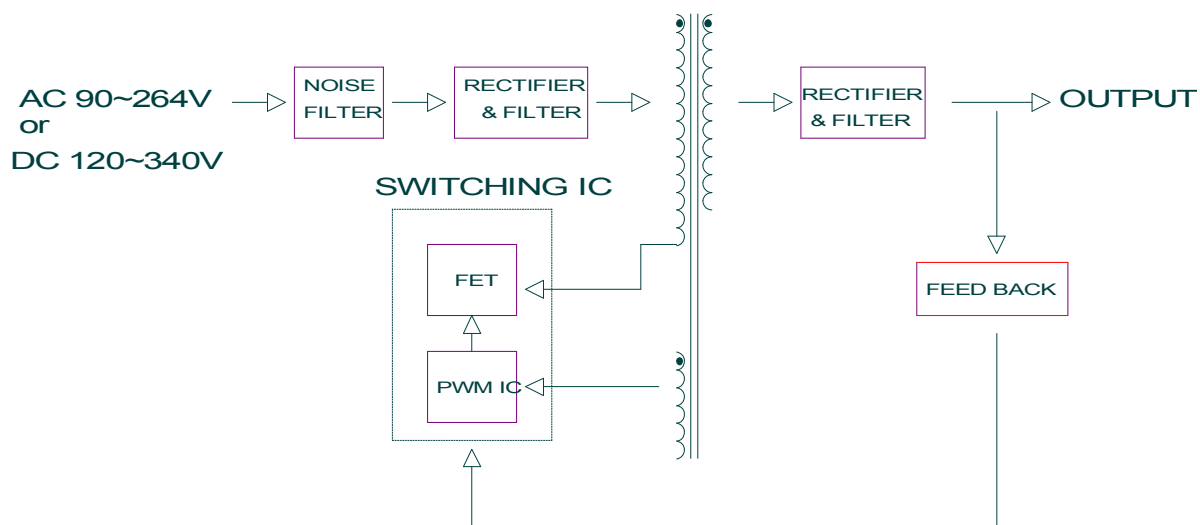

POWERPLAZA

Power Plaza co., Ltd

#1401, Daeryung Techno Town 493-6

Gasan-Dong, Kumchon-Gu, Seoul, 153-774,
Korea

Tel: 82_2_855_4955

Fax: 82_2_855_4954

E-mail: sales@powerplaza.co.kr