



W7500S2E-R1 User Manual

V1.0

Copyright © WIZnet H.K. Ltd. All rights reserved.

Document Revision History

Version	Date	Remarks
V1.0	2018/01/12	Official Release

Copyright notice

Copyright © WIZnet H.K. Ltd. All rights reserved.

Contact E-mail: supports@wiznet.hk

For more information, please visit: <https://www.wizse.com/>

Table of Contents

1	INTRODUCTION	1
1.1	FUNCTIONAL OVERVIEW.....	1
1.1.1	<i>Key features</i>	1
1.1.2	<i>Configuration methods</i>	1
1.2	SPECIFICATIONS.....	2
1.2.1	<i>Electrical characteristics</i>	2
1.2.2	<i>Dimensions</i>	3
1.2.3	<i>Thermal Characteristics</i>	3
2	HARDWARE DESCRIPTION	4
2.1	PINOUTS AND PIN DESCRIPTION.....	4
2.2	WIZS2E EVALUATION BOARD.....	6
2.3	QUICK TESTING GUIDE.....	8
3	OPERATING MODES	9
3.1	TCP SERVER MODE.....	9
3.2	TCP CLIENT MODE.....	9
3.3	UDP MODE.....	10
4	IP ADDRESS	11
4.1	MODULE IP ADDRESS FACTORY DEFAULT SETTINGS.....	11
4.2	METHOD TO GET THE IP ADDRESS OF THE MODULE.....	11
4.3	MODULE AND HOST COMPUTER NETWORK DETECTION.....	12
4.4	HOW TO SET THE IP ADDRESS OF THE HOST COMPUTER.....	13
5	WIZS2E CONFIGTOOL	14
5.1	COLLECT MODULE'S SETTING INFORMATION.....	14
5.2	MODIFY THE DEVICE SETTINGS.....	15
5.3	FACTORY RESET.....	15
5.3.1	<i>Factory reset setting by software</i>	15
5.3.2	<i>Factory reset module through AT command</i>	15
5.3.3	<i>Hardware factory reset method</i>	16
5.4	FIRMWARE UPGRADE.....	16
6	AT COMMAND CONFIGURATION	17
6.1	AT COMMAND OVERVIEW.....	17
6.2	ENTER AT COMMAND MODE.....	18
6.3	AT COMMAND LIST.....	18
6.3.1	<i>System control command list</i>	18
6.3.2	<i>Control command list</i>	18
6.3.3	<i>Serial configuration command list</i>	20
6.4	AT COMMAND DETAILS.....	21
6.4.1	<i>Basic commands</i>	21
6.4.2	<i>Control commands</i>	21
6.4.3	<i>Device configuration command list</i>	23

6.4.4	Serial control command	28
6.5	AT COMMAND CONFIGURATION EXAMPLES	32
6.5.1	Set into TCP server mode example	32
6.5.2	TCP client mode example.....	33
6.5.3	UDP mode example.....	34
7	WEB PAGE CONFIGURATION	35
7.1	MAIN PAGE	35
7.2	BASIC SETTINGS	36
7.3	ADVANCE SETTINGS	38
7.4	DEVICE MANAGEMENT	40
8	FIRMWARE UPGRADE.....	42
8.1	W7500S2E-R1 FIRMWARE UPGRADE THROUGH CONFIGTOOL.....	42

1 Introduction

1.1 Functional overview

W7500S2E-R1 is an industrial grade serial to Ethernet module. It supports TCP server, TCP client and UDP three operating modes. The maximum serial baud rate is 460,800Mbps. W7500S2E-R1 supports WIZS2E ConfigTool (Configuration Tool for Windows®), web page configuration and AT command to configure the module.

W7500S2E-R1 uses W7500 MCU with hardwired TCP/IP protocol. This enables a faster, stable and secure Ethernet connectivity. With reference schematic(s) and guideline(s) in this user manual, it could be greatly reduced the time and difficulty of the hardware design and development when comparing with other approaches.

1.1.1 Key features

- ◆ 300bps ~ 460,800bps baud rate
- ◆ Auto-negotiation 10/100 Mbps Ethernet interface with RJ-45 connector
- ◆ Support TCP server, TCP client and UDP operating modes
- ◆ Flexible serial interface data packaging condition settings
- ◆ Smart Ethernet cable detection and keep alive features
- ◆ As DHCP client to automatically acquire IP address
- ◆ As DNS client to lookup domain name
- ◆ Support NetBIOS allows user to identify module's name
- ◆ Support user password authorization for security
- ◆ Support serial AT command configuration method
- ◆ Built-in web server for browser and remote configuring
- ◆ Provide user-friendly configuration tool program (WIZS2E ConfigTool)
- ◆ Support firmware upgrade by ConfigTool

1.1.2 Product features

- ◆ 32-bit ARM MCU
- ◆ LAN interface
 - 10/100 Mbps Ethernet interface
- ◆ Serial interface
 - 3.3V TTL x1: TXD, RXD, GND
- ◆ Default Serial communication parameters
 - Baud Rate: From 300bps to 460,800Mbps
 - Data Bit: 7, 8
 - Stop Bit: 0.5, 1, 1.5, 2
 - Parity: None, Even, Odd
 - Flow Control: None, CTS/RTS
- ◆ Supporting software
 - Tool: WIZS2E ConfigTool

- ◆ Configuration methods
 - WIZS2E ConfigTool
 - Web based (via web browser)
 - Serial AT command
- ◆ Power supply
 - Input Power: 5V DC
- ◆ Size
 - 44.5 x 31.75 x 15.75 (mm)
- ◆ Storage temperature
 - Industrial Grade: -40 ~ +85 °C
- ◆ Storage environment
 - -40 ~ +85 °C, 5 ~ 95% RH

1.1.3 Configuration methods

W7500S2E-R1 provides three types configuration methods for user to operate with the module.

- ◆ WIZS2E ConfigTool is a computer software configuration tool. It can be installed and run in Windows® environment.
- ◆ Web page configuration allows user locally or remotely to configure the module through web browser.
- ◆ AT command configuration support sending serial commands from the mainboard of the embedded device or from the serial terminal to configure the parameters of WIZS2E modules.

1.2 Specifications

1.2.1 Electrical characteristics

1.2.1.1 Voltage and current characteristics

The following table 1-1 and 1-2 was the result tested in 25°C environment.

Symbol	Types	Ratings			
		Min	Normal	Max	Unit
V _{DD}	Module Voltage	2.97	3.3	3.6	V
I	Module Current	101	106	157	mA

Table 1-1 Voltage and current characteristics

1.2.1.2 Current characteristics

Working Mode	Ratings (mA)	Working Mode	Ratings (mA)
Standby	101	100Mbps without connection	157
10Mbps without connection	106	100Mbps with data communication	157
10Mbps with data communication	106		

Table 1-2 Current characteristics

1.2.2 Dimensions

For fitting the module into your design, please refer to the reference figure 1-1; It shows all the dimensions of the modules. In the figure, it provides the regulation for three dimensions with the distance of upper and lower parts pin headers and the location of the one mounting holes. The pin header has pitch 2.54mm.

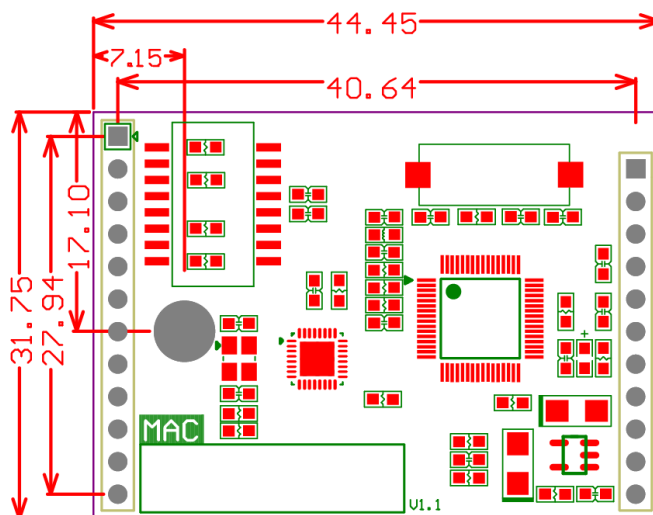

Figure 1-1 W7500S2E-R1 dimensions top view

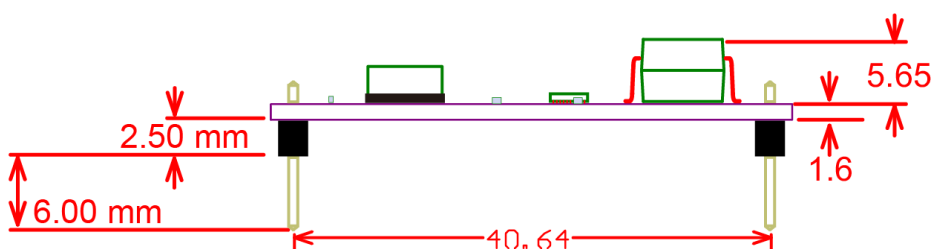

Figure 1-2 W7500S2E-R1 dimensions side view

1.2.3 Thermal Characteristics

Part Number	Grade	Storage temperature	Storage temperature
W7500S2E-R1	Industrial Grade	-40 ~ +85 °C	-40 ~ +85 °C

Table 1-3 Thermal characters

2 Hardware description

2.1 Pinouts and pin description

The following section will introduce W7500S2E-R1 pin header explanation and the usage of WIZS2E evaluation board.

The following figure 2-1 is the appearance of WIZS2E module. From this figure, we could identify there are 3 rows of pin headers on the module as hardware connectors for users. J1 is a 1x12 single row 2.54mm pin and J2 is 1x11 double row 2.54mm pins.

Figure 2-2 is the pin assignment of W7500S2E-R1, table 2-1 and 2-2 are the pin header description of W7500S2E-R1 module.



Figure 2-1 W7500S2E-R1 module



Figure 2-2 W7500S2E-R1 pinout

Table 2-1 W7500S2E-R1 J1 pin definition

Pin No.	Pin Name	I/O	Function
1	NC11	-	-
2	NC10	-	-
3	NC9	-	-
4	NC8	-	-
5	DATA_LED	O	Ethernet Status Indicator
6	TXD	O	Serial output signal
7	RXD	I	Serial input signal
8	RTS	I/O	Serial RTS signal
9	DEFAULT	I	Active low, pull down over 3s for factory reset
10	RESET	I	Hardware reset pin
11	GND	-	GND
12	GND	-	GND

Table 2-2 W7500S2E-R1 J2 pin definition

Pin No.	Pin Name	I/O	Function
13	VCC	-	VCC
14	VCC	-	VCC
15	LINK_LED	O	Ethernet link indicator
16	NC7	-	-
17	NC6	-	-
18	NC5	-	-
19	NC4	-	-
20	NC3	-	-
21	CTS	I/O	Serial CTS signal pin
22	NC2	-	-
23	NC1	-	-

2.2 WIZS2E evaluation board



Figure 2-3 WIZS2E evaluation board

WIZS2E evaluation board provides a simple platform for testing and running an application for WIZS2E modules including W7500S2E-R1. Where Z1-J1 and Z1-J2 are used to plug in the W7500S2E-R1 module, S1-J1 and S1-J2 are used to plug in other models of WIZS2E module (s), which are described in the user manuals of the related modules. The evaluation board integrates RJ45, serial TTL and USB mini interfaces. (The following figure shows “x” means vacant)

- TTL interface (P2) Pin Assignment

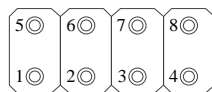

Pin	Signal	Pin	Signal
1	5V	5	3V3
2	GND	6	GND
3	TX	7	RTS
4	RX	8	CTS

- USB Mini Interface (J6) Pin Assignment supply 5 V DC power for the evaluation board only.

Note: Not for debug or communication

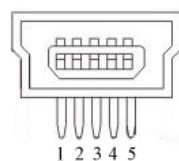

Pin	Signal	Pin	Signal
1	5V	4	x
2	x	5	GND
3	x		

- SW3 is power supply pin for other modules, it would be leave open for W7500S2E-R1

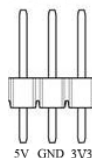

Pin	Signal	Pin	Signal
1	5V	3	3V3
2	VCC		

◆ W7500S2E-R1 evaluation board buttons introduction

Marking	Description
SW1 (DEFAULT)	Press switch for 1-3 seconds for soft reset, over 3 seconds to factory reset
SW2 (RESET)	Hardware reset button

Figure 2-4 W7500S2E-R1 evaluation board button description

◆ W7500S2E-R1 evaluation board LED description

Marking	Description
ACT	Ethernet status indicator
LINK	Ethernet connection indicator
DATA	Ethernet data communication LED, the Blink speed shows the data speed

Table 2-5 W7500S2E-R1 evaluation board LED description

◆ Hardware connection explanation

W7500S2E-R1 used two sections of pin layouts in 1 x 7 pin and 2 x 7 pin designs. This is to avoid plugging the module in the wrong directing which may damage to the module.

◆ Figure 2-4 shows the reference schematic of the evaluation board for developing reference.

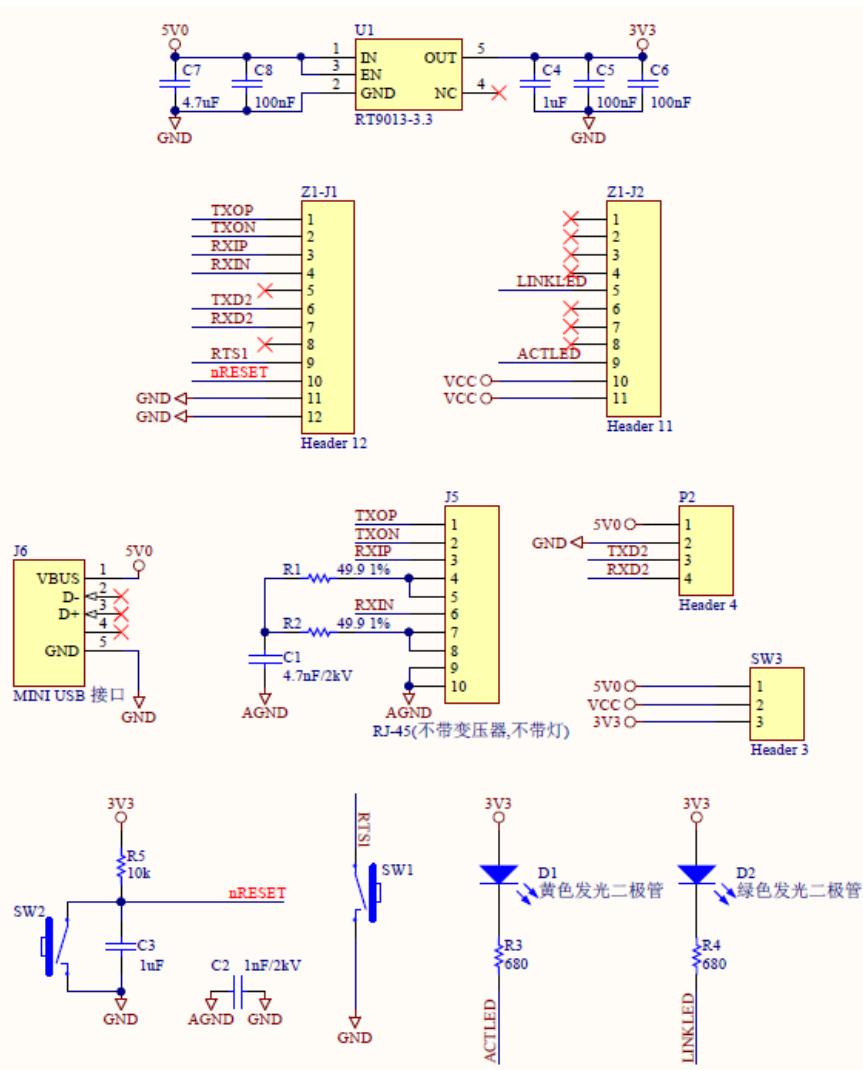

Figure 2-4 W7500S2E-R1 evaluation board reference schematic

2.3 Quick testing guide

W7500S2E module can upgrade products or devices from serial interface to Ethernet interface. Evaluation board can be used for a quick test before implementing the module into the design. By connecting the serial interface to the module and Ethernet interface connected to the host computer, the user could easily control the serial device through Ethernet as shown in Figure 2-5.

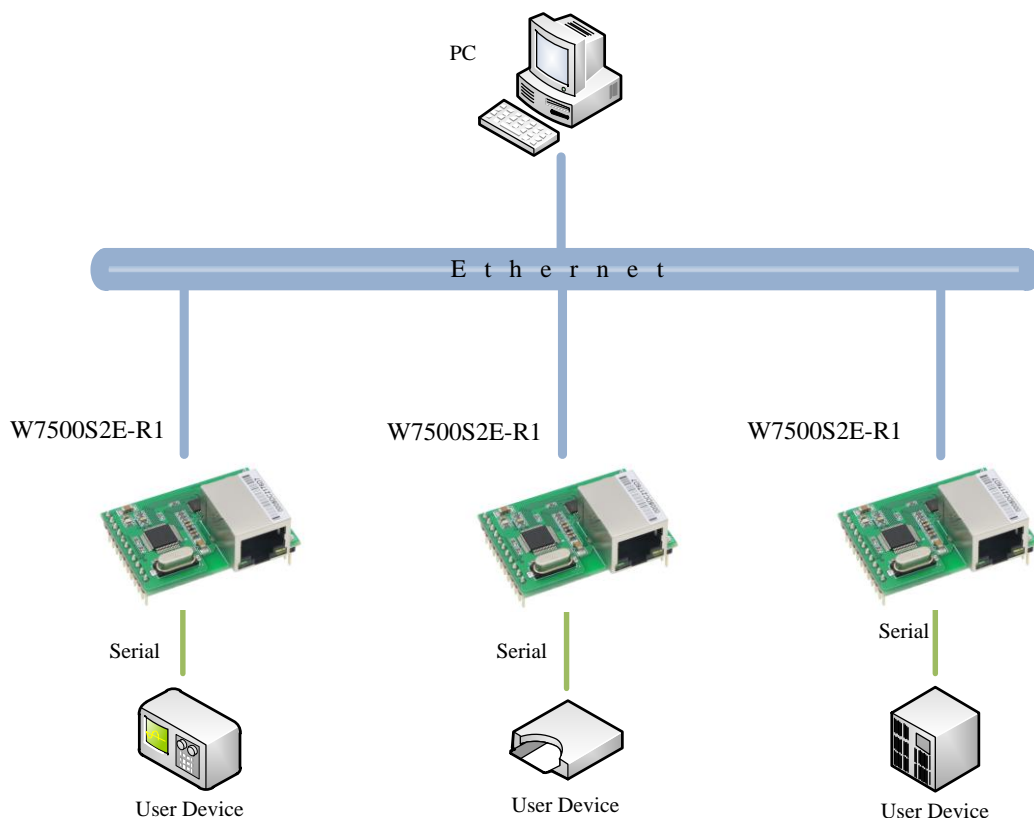

Figure 2-5 W7500S2E-R1 module testing evaluation block diagram

Using LAN cables and USB to Serial (TTL) cables to connect from the host computer and to the respective LAN ports and TTL ports of the evaluation board. This will create a simple testing network; The IP address of the host computer's wired network card is changed according to the 4.4 chapters, the user can send/receive data through the network port, receive/send from the serial port, and conduct a simple testing and evaluation.

3 Operating modes

WIZS2E module supports TCP server, TCP client and UDP modes; Below demonstrate these operating modes.

3.1 TCP server mode

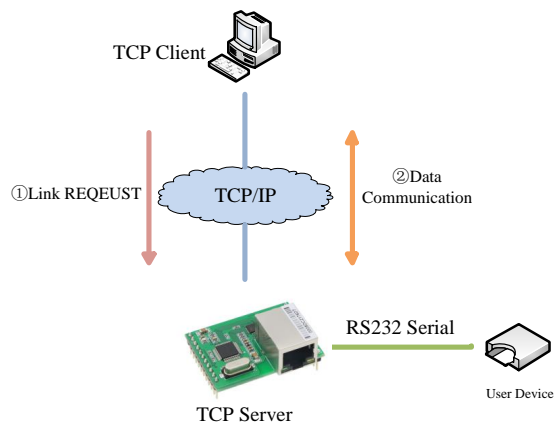

Figure 3-1 TCP server mode diagram

Figure 3-1 shows, W7500S2E-R1 module open a local port to listen TCP requests in TCP server mode. The default port number is 5000 and it is waiting for client connections. After the connection has created, it will start data communication.

3.2 TCP client mode

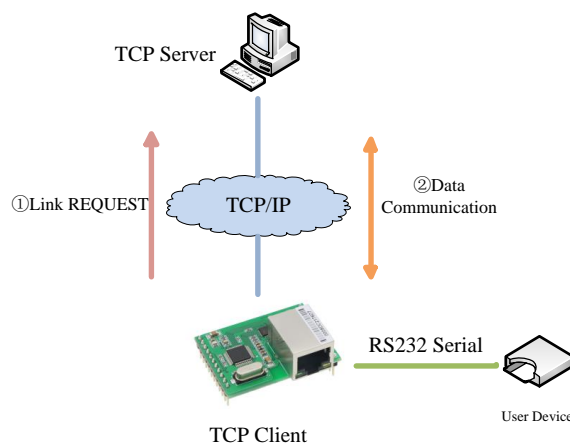

Figure 3-2 TCP client mode diagram

According to figure 3-2, W7500S2E-R1 module will starts to connect to TCP server that set in the module for TCP client mode. If connection fails, client will base on reconnection setting condition and try to connect with the TCP server. After its connected, it will start data communication.

3.3 UDP mode

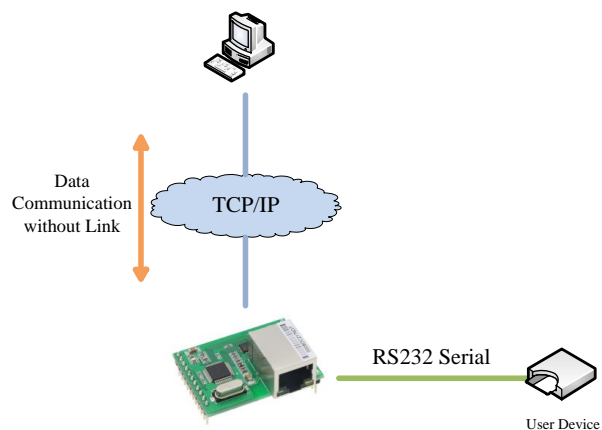

Figure 3-3 UDP mode diagram

For UDP mode in Figure 3-3, W7500S2E-R1 module is required to have the remote IP address and port number to create an UDP communication. UDP mode communicate is not based on “connection”. Therefore, it does not guarantee the target device could receive the data correctly or not. Thus, it requires an upper layer communication protocol to communicate for ensuring the data accuracy. However, since UDP mode is a simple communication protocol, it could provide a better communication speed due to less workload on data accuracy. In fact, UDP are not likely to get data error in network environment under normal workload. In this operating mode, both devices are equal and they do not differentiate into server or client.

4 IP address

Before using the module, we need to know some parameters like IP address. This module support “Static” and “DHCP” IP collection method. For “Static” mode, user could manually change the IP address, subnet mask & gateway parameters. The emphasis here is that the IP address of the module cannot be the same as the IP address of other devices in the same LAN. i.e. the module will activate DHCP protocol to collect IP address, subnet mask and gateway information from the DHCP server.

4.1 Module IP address factory default settings

WIZS2E Serial to Ethernet module’s factory default IP address: 192.168.1.88.

4.2 Method to get the IP address of the module

No matter forgotten the IP address of the module or the module is working on DHCP mode, the current IP address of the module could be searched using the WIZS2E ConfigTool. The following steps are the method to use WIZS2E ConfigTool to search the IP address for WIZS2E module:

1. Connect the host computer and the module with LAN cable and power up the module.
2. Run the WIZS2E ConfigTool and it shows as the following 4-1 figure.

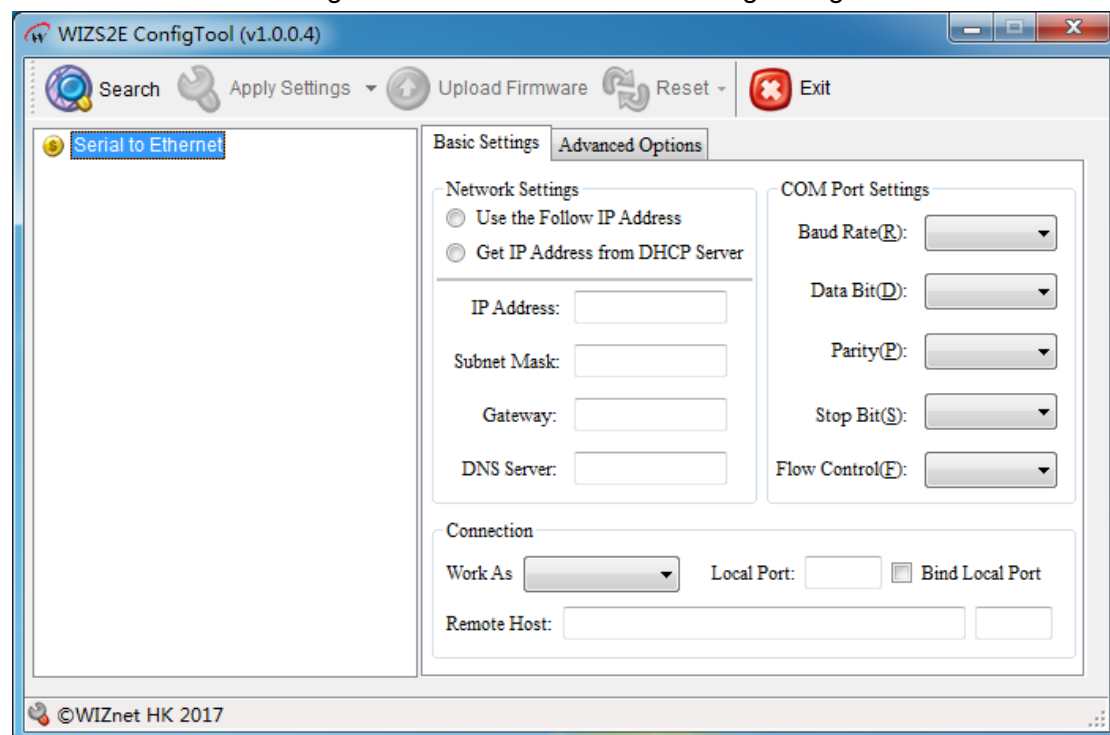



Figure 4-1 WIZS2E ConfigTool interface

3. Press  button, it shows the IP address information as the following figure 4-2.

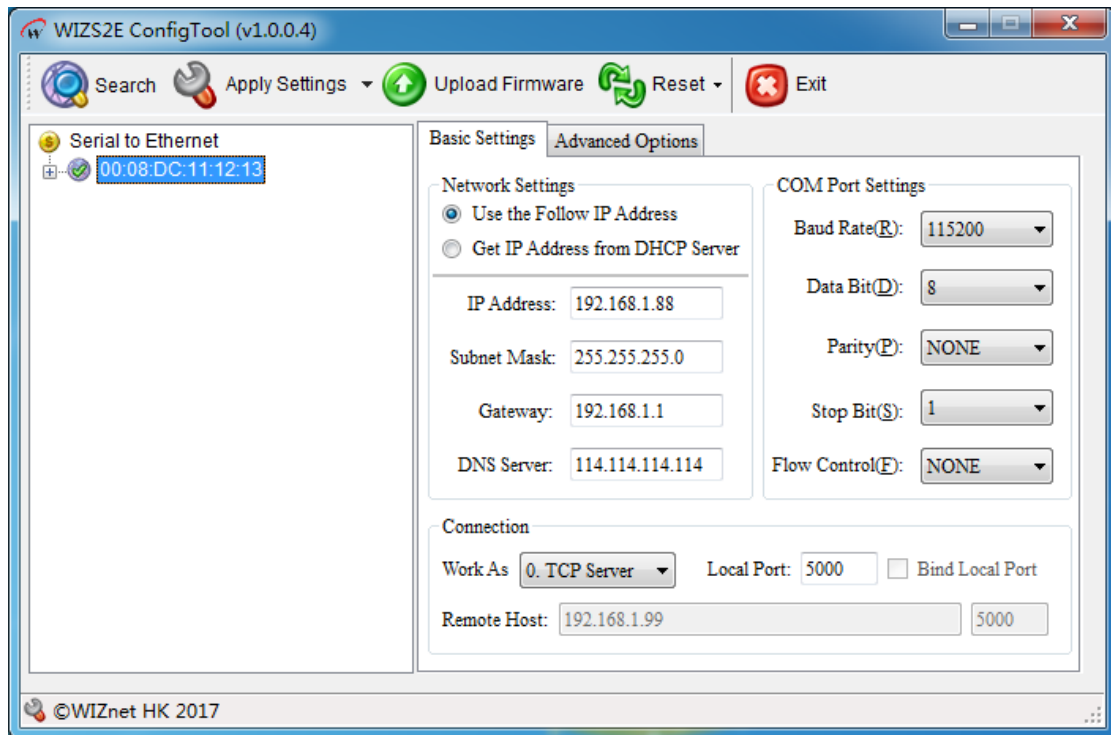

Figure 4-2 WIZS2E ConfigTool search result

4.3 Module and host computer network detection

Before starting to communicate between the WIZS2E module and the host computer, please ensure the host computer and the module are in the same network segment. The factory default setting for IP address and Subnet mask in WIZS2E module are 192.168.1.88 and 255.255.255.0 respectively. User could follow the flow diagram 4-3 to understand the communication procedure between the module and the host computer. If they are in the same network segment, it could communicate with the module. Otherwise, the host computer needs to change its IP address to communicate with the module.

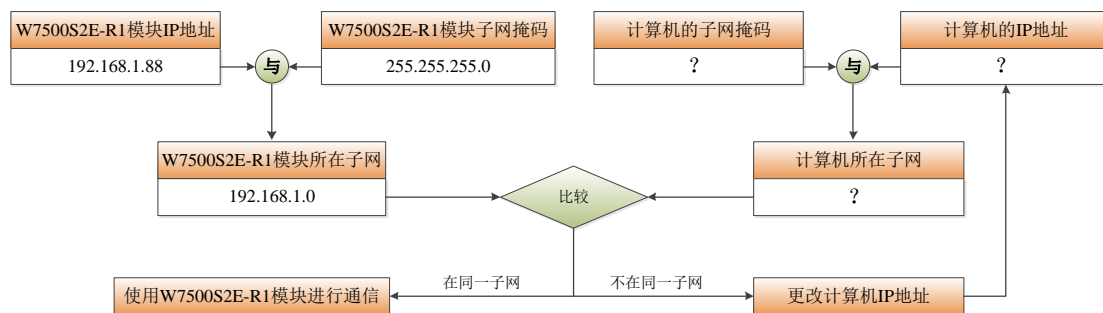

Figure 4-3 WIZS2E module and IP segment of host computer flow diagram

4.4 How to set the IP address of the host computer

The following procedure is based on Windows® 7 Operation System.

Press “Start” → “Control Panel” → “Network Sharing Centre” → “Changing adaptor setting” → “Local connection” → Right Click “Properties” → Double Click “Internet protocol version 4 (TCP/IPv4)”. After all these procedures, you could get into the result as the following figure shows. Please choose “Using the following IP addresses” for inputting the IP address as 192.168.1.99, the subnet mask is 255.255.255.0 and default gateway into 192.168.1.1. The DNS section could ignore. Finally, please click “Enter” for saving these settings and starts to communicate with WIZS2E module.

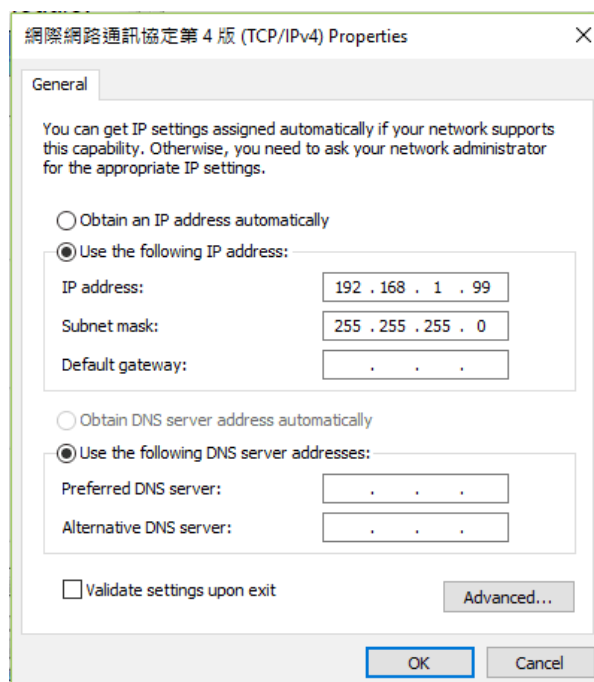



Figure 4-4 Window 7 (Chinese version) IP address setting interface

5 WIZS2E ConfigTool

WIZS2E ConfigTool is a Windows® configuration tool compatibles to W5500S2E and W7500S2E series modules. WIZS2E ConfigTool can be used to search, enquiry and configure W5500S2E and W7500S2E device features and information.

5.1 Collect module's setting information

Click the toolbar's  button, WIZS2E ConfigTool will search all WIZS2E module that has connected in the same network segment (Direct connect or under the same router). The figure 5-1 shows the result as mentioned. The search section shows all the modules in MAC address format as the parent node for the list of information of WIZS2E module. By pressing the “+” button, it shows the detail information about this module. After pressing the MAC address of that specific module, it will list out all the IP address, serial interface settings and other parameters of this module. This information presents on the Basic settings and Advance Option tab that were next to the search section.

Note: Prior configuration, it is recommended that you disable other unrelated network adapters in your host computer (including virtual network adapters, if you use the wired network adapter configuration module to turn off the wireless network card) and ensure that all device IP addresses in the LAN are not conflicting.

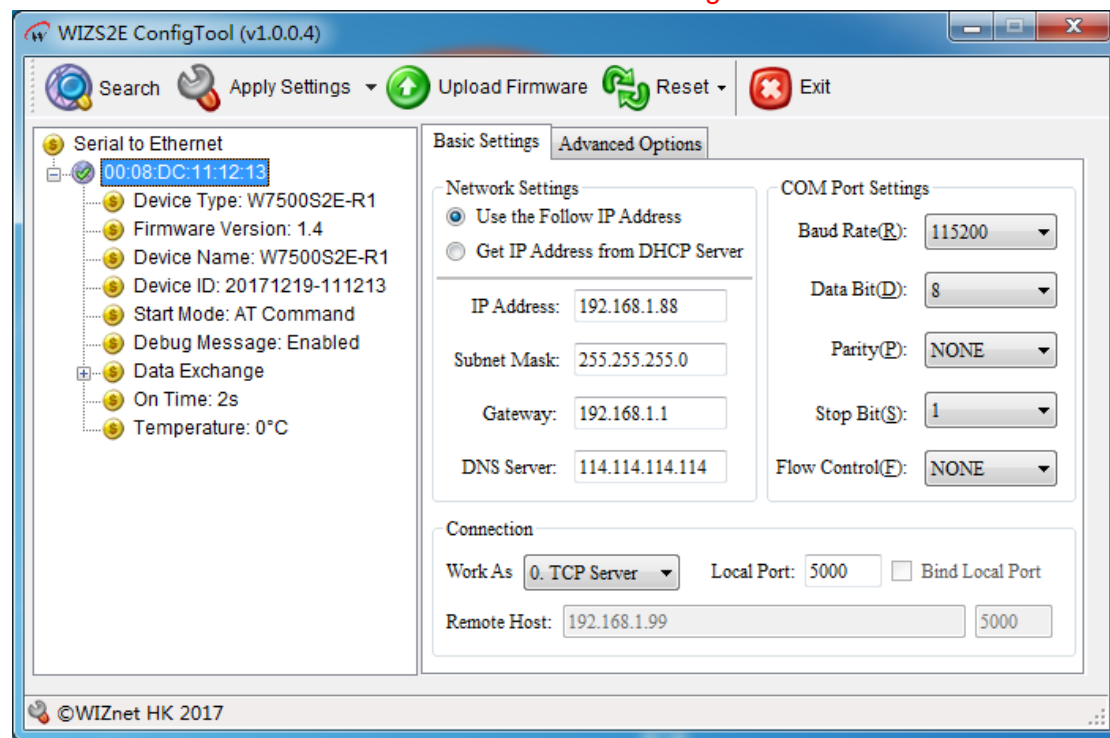

Figure 5-1 WIZS2E ConfigTool basic settings interface

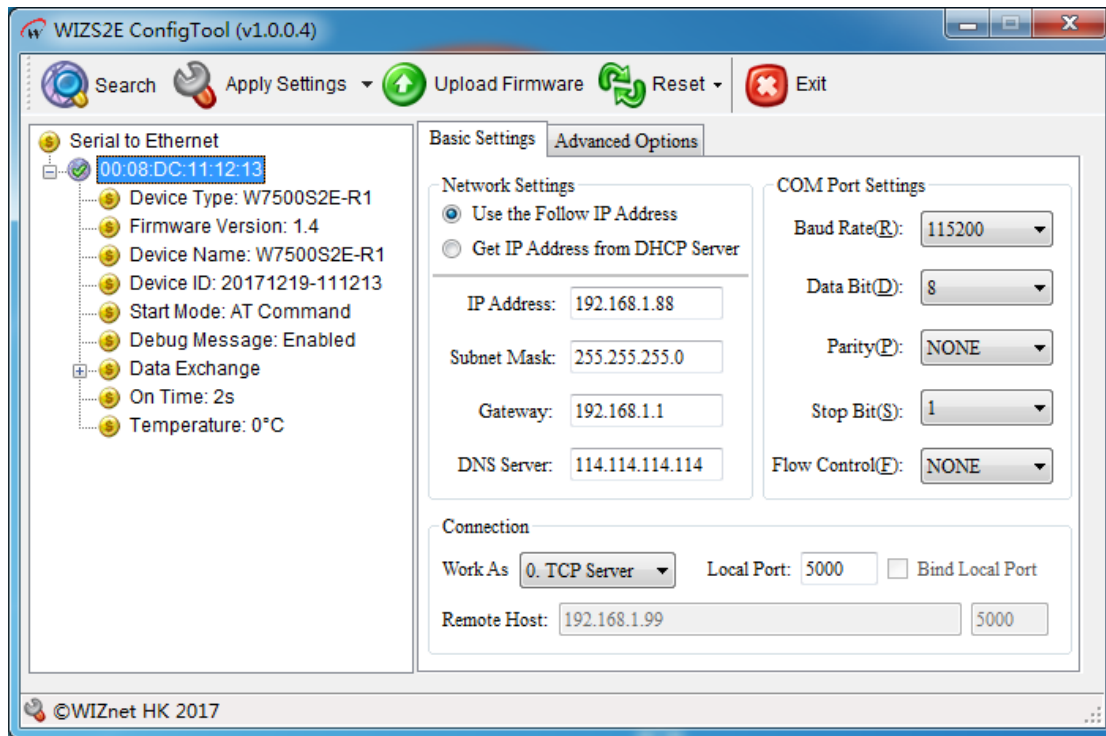
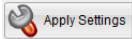

Figure 5-2 WIZS2E ConfigTool advance options interface

5.2 Modify the device settings

After searching the module, user could directly go to “Basic Settings” and “Advance Options” to configure the module. Please press  button to save your configuration.

5.3 Factory reset

If the customer found out some uncertainties with the WIZS2E module, the user could reset the module back to factory default setting to solve the problem. There are three kinds of method to factory: Software (ConfigTool), AT command and hardware reset.

5.3.1 Factory reset setting by software

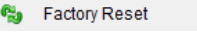
- I. In the WIZS2E ConfigTool, please click the module on the search section that needs to factory reset.
- II. Please press toolbar's  →  factory reset button to reset the module back to default settings.

5.3.2 Factory reset module through AT command

For detail information about this AT command (AT+DEFAULT) for factory reset, please refer section 6.4.2.6.

5.3.3 Hardware factory reset method

5.3.3.1 Factory reset through evaluation board



Figure 5-3 The evaluation board reset button

After providing power to the module, please press the DEFAULT button for more than 3 seconds to apply factory reset procedure.

5.3.3.2 Factory reset through module



Figure 5-4 through the module default PIN to restore factory settings

W7500S2E-R1 has a restored factory set PIN. After power on the module, pull down the DEFAULT pin for 3 seconds to activate factory default.

5.4 Firmware Upgrade

W7500S2E-R1 supports host computer firmware upgrade. For detail information, please refer section 8 Firmware upgrade.

6 AT command configuration

W7500S2E-R1 supports AT command configuration method. This method could only apply when W7500S2E-R1 is in command mode. User needs to send the AT serial command mentioned in this section, W7500S2E-R1 could be modified by requirement. User could use serial terminal or MCU main board that connected with W7500S2E-R1 for applying these configurations.

6.1 AT command overview

AT command is case insensitive. Except the “+++” command, all other commands are starting with string “AT”. These commands activate after received CRLF (Carriage-Return Line-Feed). This means “\r\n” (“0x0d 0x0a” in HEX). These commands and related parameters are defined. Sending wrong characters or sending in the inappropriate format will return an error.

AT commands have 4 types:

1. +++
Exit from data mode and changed to command mode.
2. Command without parameter
Format: AT+ <command>\r\n, No extra parameters or symbol after the command. For example: AT+EXIT\r\n.
3. Query Command
Format: AT+<command>?\r\n, this kind of command is checking the command's parameter value. In example: AT+ECHO?\r\n.
4. Commands with parameter
Format: AT +
<command>=<parameter1>,<parameter2>,<parameter3>...\r\n this will set the command's parameter value.

Based on users AT command inputs, W7500S2E-R1 will reply related return value. These values included correct and error message as showed on the following 6-1 table.

Return Value Type	Return Value	Meaning
Correct Input message	[Command] Value is: <value>\r\nOK\r\n	Command execute correctly
Wrong Input Message	Command Invalid\r\nERROR\r\n	Command Invalid
	<Error Info>\r\n	Invalid parameter input
	Password Error\r\nERROR\r\n	Password Error

Table 6-1 AT command return value list

6.2 Enter AT command Mode

W7500S2E-R1 has two modes, AT command mode and data mode. In AT command mode, user could use serial terminal or through user's MCU main board to configure the parameters of the module. Command enter will return a value (In echo mode, it will show the serial message). In data mode, all the commands except the "+++" would be ignored to the module. Thus, entering the "+++" command will change the module into AT command mode.

Note: "+++" command rules: It needs to send "+" symbol continuously in 3 times to through serial interface to the module. This command requires 1 second gap each before and after this command has entered to activate the correct response from W7500S2E-R1. If not, it will consider as user's data input. This command does not require CRLF (Carriage-Return Line-Feed)(\r\n). The factory default setting of the module is in AT command mode.

6.3 AT command list

The following list is the AT command (case insensitive)list and related return value that supports by WIZS2E module. The type "R" stands for read only. "R/W" means it could read and write. "< >" it means mandatory parameter. "[]" it means optional parameters. AT commands are classified into four categories: Basic commands, Control commands, device configuration commands and serial configuration commands

6.3.1 System control command list

Features	Command
Terminal check	AT
Entering command mode	+++
Exit command mode	AT+EXIT

6.3.2 Control command list

Features	Command	Type	Max length	Parameters / Description
Echo	AT+ECHO	R/W	1	0: Close echo 1: Open echo (Default)
List of commands	AT+LIST	R	0	Queries only: AT+LIST?
List of default / current values	AT+PRE	R	0	Queries only: AT+PRE?
Factory reset	AT+DEFAULT	W	16	Required Password (Case sensitive)
Reset	AT+RESET	W	16	Required Password (Case sensitive)
Ethernet send counter	AT+NETSEND	R	0	Queries only: AT+NETSEND?
Ethernet receive counter	AT+NETRCV	R	0	Queries only: AT+NETRCV?
Device uptime	AT+RUNTIME	R	0	Queries only: AT+RUNTIME?
Firmware version	AT+VER	R	0	Queries only: AT+VER?

6.3.3 Device configuration command list

Features	Command	Type	Max length	Parameters / Description
Device ID	AT+SN	R	0	Queries only: AT+SN?
Device type	AT+TYPE	R	0	Queries only: AT+TYPE? Reply: W7500S2E-R1
Device name	AT+NAME	R/W	15	Can set into any characters Default: W7500S2E-R1
Device password	AT+PASS	R/W	15	Must be numbers, alphabets or the mixed of both; blank input is not allowed
Device IP address	AT+IP	R/W	15	Default: 192.168.1.88
Local port number	AT+C1_PORT	R/W	5	Maximum: 65535, default: 5000
Local port binding	AT+C1_BIND	R/W	1	Only available on TCP Client mode: 0: Disable 1: Enable
Device subnet mask	AT+MARK	R/W	15	Default: 255.255.255.0
Device gateway	AT+GATEWAY	R/W	15	Default: 192.168.1.1
Operating mode	AT+C1_OP	R/W	1	0: TCP server (default) 1: TCP Client 3: UDP 2: Reserved 4: Not available
Start Mode	AT+START_MODE	R/W	1	0: AT command mode (default); 1: Data transmission mode
IP address (Remote host)	AT+C1_CLI_IP1	R/W	15	Default: 192.168.1.99
Port number (Remote host)	AT+C1_CLI_PP1	R/W	5	Max: 65535, Default: 5000
DNS server address	AT+DNS	R/W	15	Default: 114.114.114.114
MAC address	AT+MAC	R	17	Queries only: AT+MAC? Format: 00: 08: DC: XX: XX: XX (factory preset)
IP collection method	AT+IP_MODE	R/W	1	0: Static IP mode (default) 1: DHCP mode
Web port number	AT+WEB_PORT	R/W	5	Max: 65535, Default: 80
Remote host name	AT+DOMAIN	R/W	32	Default: www.iwiznet.cn
DNS	AT+DNSEN	R/W	1	0: Disable (default) 1: Enable
Print debug information	AT+DEBUGMSGEN	R/W	1	0: Disable (default); 1: Enable
Time to reconnect	AT+RECONTIME	R/W	5	Only available on TCP client mode Value range: 0~60000; Unit: ms Default: 0 (reconnect immediately)
NetBIOS	AT+NETBIOS	R/W	1	0: Disable (default) 1: Enable

6.3.3 Serial configuration command list

Features	Command	Type	Max length	Parameters / Description
Serial port 1 parameters	AT+COM1	R/W	10	Parameters format: [baud],[datab],[parity],[stopb],[c] Default: 7,1,0,1,0
Baud rate	AT+C1_BAUD	R/W	2	0: 300; 1: 600; 2: 1200; 3: 2400; 4: 4800; 5: 9600; 6: 14400; 7: 19200; 8: 38400; 9: 56000; 10: 57600; 11: 115200 (default); 12: 128000; 13: 230400; 14: 256000; 15: 460800
Data bit	AT+C1_DATAB	R/W	1	0: 7 bit 1: 8 bit (default)
Stop bit	AT+C1_STOPB	R/W	1	0: 1 bit (default) 1: 2 bit
Parity bit	AT+C1_PARITY	R/W	1	0: none (default) 1: odd 2: even
Serial flow control	AT+C1_SER_C	R/W	1	0: none (default) 1: Hardware flow control
Clear out serial buffer	AT+C1_BUF_CLS	R/W	1	Only available on TCP modes 0: Keeps data in serial after connection has created (default) 1: Clear data in serial after connected has created
Data packaging (length)	AT+C1_SER_LEN	R/W	4	Value range: 0~2048 byte; Default: 0 (Disable data packaging by size)
Nagle algorithm wait time (ms)	AT+C1_SER_T	R/W	5	Value range: 0~60000, unit: ms; Default: 0 (Disable data packaging by period)
Inactivity time (ms)	AT+C1_IT	R/W	5	Only available on TCP modes Value range: 0 ~ 60000, unit: ms; Default: 0 (disable this function)
TCP keep alive time (ms)	AT+C1_TCPAT	R/W	3	Only available on TCP modes Value range: 0~255, unit 5s; Default: 0 (disable this function)
TCP authentication	AT+C1_LINK_P	R/W	1	Only available on TCP server mode 0: No password is required for TCP connection (Default) 1: Required password for TCP connection

Features	Command	Type	Max length	Parameters / Description
TCP link establishment condition	AT+C1_LINK_T	R/W	1	Only available on TCP client 0: Reconnect after power up the module (default) 1: Reconnect after received data from serial interface
TCP link establishment message	AT+C1_LINK_M	R/W	1	Only available on TCP modes 0: No message 1: Send Device ID 2: Send MAC address 3: Send IP address
bytes sent by serial	AT+C1_SEND_NUM	R	-	Queries only: AT+C1_SEND_NUM? Counter range: 0 ~ 4,294,967,295
bytes received by serial	AT+C1_RCV_NUM	R	-	Queries only: AT+C1_RCV_NUM? Counter range: 0 ~ 4,294,967,295

6.4 AT command details

6.4.1 Basic commands

6.4.1.1 Terminal check (AT)

Command format	Parameters / Description	Usage
AT	Nil	Terminal check
return value	OK\r\n	

Check the terminal device is it working. If it is working normally with the module, it will return “OK” value. If the terminal is not working, it will not return anything.

6.4.2 Control commands

6.4.2.1 Enter command mode (+++)

Command format	Parameters / Description	Usage
+++	Nil	Exit from data mode
Return value	AT-Command Interpreter ready\r\n	

Under W7500S2E-R1's data mode, transmitting “+++” through serial interface in the same time will change the module from data mode to command mode.

6.4.2.2 Exit command mode (AT+EXIT)

Command format	Parameters / Description	Usage
AT+EXIT\r\n	Nil	Exit command mode
Return value	OK\r\nListening on XXX.XXX.XXX.XXX: XXX \r\n	

After finished configured the settings in command mode, user needs to input “AT+EXIT\r\n” for

saving the settings and exit from the command mode to data mode. Any updated parameter in this session will only be saved into EEPROM after executing this command.

6.4.2.3 Echo (AT+ECHO)

Command format	Parameters / Description	Usage
AT+ECHO=<echo>\r\n	<echo> 0: Close Echo feature	Define new value
AT+ECHO?\r\n	1: Open Echo feature (default)	Query current value
Return value	[ECHO] Value is: <echo>\r\nOK\r\n	

Echo means W7500S2E module could directly return any input values to the serial interface. Thus, this option may help some users working more easily through serial terminal software. However, this may cause trouble if the serial is connected to an embedded system. Turn off this function in this case.

6.4.2.4 List of commands (AT+LIST)

Command format	Parameters / Description	Usage
AT+LIST?\r\n	Nil	Query current value
return value	<AT command list>\r\nOK\r\n	

6.4.2.5 List of default / current values (AT+PRE)

Command format	Parameters / Description	Usage
AT+PER?\r\n	Nil	Query current value
return value	DEFAULT: \r\n<default list>\r\nCURRENT: \r\n<current list>\r\n	

6.4.2.6 Factory reset (AT+DEFAULT)

Command format	Parameters / Description	Usage
AT+DEFAULT=<pass>\r\n	<pass>: [device password]	Reset to factory default settings
Return value	OK\r\n<factory info>\r\n	

Exact password must be imputed to executed this command. When this command is successfully executed, the module restores the factory default settings and enters to AT command mode. Device password can be queried and set through "AT+PASS".

6.4.2.7 Reset (AT+RESET)

Command format	Parameters / Description	Usage
AT+RESET=<pass>\r\n	<pass>: [device password]	Reset the module
Return value	OK\r\n<factory info>\r\n	

Exact password must be imputed to executed this command. The module will be in data mode after reset. Device password can be queried and set through "AT+PASS".

6.4.2.8 Ethernet send counter (AT+NETSEND)

Command format	Description	Usage
AT+NETSEND?\r\n	Nil	Query the byte of data sent by Ethernet interface
Return value	[NETSEND] Value is: <number>\r\nOK\r\n	

Value ranged is 0 to 4,294,967,295.

6.4.2.9 Ethernet receive counter (AT+NETRCV)

Command format	Description	Usage
AT+NETRCV?\r\n	Nil	Query the byte of data received from Ethernet interface
return value	[NETRCV] Value is: <number>\r\nOK\r\n	

Value ranged is 0 to 4,294,967,295.

6.4.2.10 Device uptime (AT+RUNTIME)

Command format	Description	Usage
AT+RUNTIME?\r\n	No	Query current value
Return value	[RUNTIME] Value is: <time>000-00-18-26\r\nOK\r\n	

Received the device uptime of the WIZS2E module; Unit: seconds

Return format: ddd-hh-mm-ss

6.4.2.11 Firmware version (AT+VER)

Command format	Description	Usage
AT+VER?\r\n	Nil	Query current value
Return value	[VER] Value is: <firmware version>\r\nOK\r\n	

6.4.3 Device configuration command list

6.4.3.1 Device ID (AT+SN)

Command format	Description	Usage
AT+SN?\r\n	Nil	Query current value
Return value	[SN] Value is: <device ID>\r\nOK\r\n	

Device ID of the WIZS2E module for identification. It contains the last 6 HEX of the MAC address. This attribute is read only.

6.4.3.2 Device type (AT+TYPE)

Command format	Description	Usage
AT+TYPE?\r\n	Nil	Query current value
Return value	[TYPE] Value is: W7500S2E-R1\r\nOK\r\n	

Device type is clarifying the device is a serial to Ethernet module. This attribute is read only.

6.4.3.3 Device name (AT+NAME)

Command format	Description	Usage
AT+NAME=<name>\r\n	<name>	Define new value
AT+NAME?\r\n	Device name: it can be any character; the maximum length is 15 byte; user defined for identification	Query current value
Return value	[NAME] Value is: <name>\r\nOK\r\n	

Users can use this parameter to distinguish multiple devices in the same LAN.

Note: Device names require naming rules that conform to the NetBIOS Function (AT+NETBIOS) command if you use the NetBIOS feature.

6.4.3.4 Device password (AT+PASS)

Command format	Parameters	Usage
AT+PASS=<pass>\r\n	<pass>	Define new value
AT+PASS?\r\n	Device Password: It only accepts numbers, alphabets or the combination of both. It does not accept blank as input. Maximum input length: 16 bytes, Default: admin	Query current value
Return value	[PASS] Value is: <pass>\r\nOK\r\n	

6.4.3.5 Device IP address (AT+IP)

Command format	Parameters	Usage
AT+IP=<ip>\r\n	<ip>	Define new value
AT+IP?\r\n	Device IP address, default: 192.168.1.88	Query current value
Return value	[IP] Value is: <ip>\r\nOK\r\n	

W7500S2E-R1 support IP address format is separate in 4 sections; each section is a decimal value and using a dot to separate. The value range for each section is 0-255 therefore the maximum value size for IP address is 15 bytes. This command could not accept xxx.xxx.xxx.0 or xxx.xxx.xxx.255 value inputs.

6.4.3.6 Local port number (AT+C1_PORT)

Command format	Parameters	Usage
AT+C1_PORT=<port>\r\n	<port>	Define new value
AT+C1_PORT?\r\n	Local port number, Default: 5000	Query current value
Return value	[C1_PORT] Value is: <port>\r\nOK\r\n	

This command defines port number of the module. It is required to use under TCP server and UDP modes. The module will use this port number to communicate with other devices. The value range is 0 to 65535 (Port 80 is default port for web page configuration. Please avoid using this port number.)

6.4.3.7 Local port binding (AT+C1_BIND)

Command format	Parameters	Usage
AT+C1_BIND=<bind>\r\n	<bind>	Define new value
	0: Disable binding local port number	

AT+C1_BIND?\r\n	1: Enable binding local port number	Query current value
Return value	[C1_BIND] Value is: <bind>\r\nOK\r\n	

Only available on TCP client mode.

6.4.3.8 Device subnet mask (AT+MARK)

Command format	Parameters	Function features
AT+MARK=<mark>\r\n	<mark>	Define new value
AT+MARK?\r\n	Device subnet mask, default: 255.255.255.0	Query current value
Return value	[MARK] Value is: <mark>\r\nOK\r\n	

Subnet mask format is separate in 4 sections; each section is a decimal value and using a dot to separate. The value range for each section is 0-255 therefore the maximum value size for subnet mask is 15 bytes.

6.4.3.9 Device gateway (AT+GATEWAY)

Command format	Parameters	Usage
AT+GATEWAY=<gateway>\r\n	<gateway>	Define new value
AT+GATEWAY?\r\n	Device gateway, default: 192.168.1.1	Query current value
Return value	[GATEWAY] Value is: <gateway>\r\nOK\r\n	

This subnet mask format is separate in 4 sections; each section is a decimal value and using a dot to separate. The value range for each section is 0-255 therefore the maximum value size for Gateway address is 15 bytes. This command could not accept xxx.xxx.xxx.0 or xxx.xxx.xxx.255 value inputs.

6.4.3.10 Operating mode (AT+C1_OP)

Command format	Parameters	Function feature
AT+C1_OP=<mode>\r\n	<mode> 0: TCP server (default)	Define new value
AT+C1_OP?\r\n	1: TCP Client; 2: UDP	Query current value
Return value	[C1_OP] Value is: <mode>\r\nOK\r\n	

6.4.3.11 Start Mode (AT+START_MODE)

Command format	Parameters	Usage
AT+START_MODE =<mode>\r\n	<mode>	Define new value
AT+START_MODE?\r\n	0: AT command mode (default); 1: Data transmission mode	Query current value
Return value	[START_MODE] Value is: <mode>\r\nOK\r\n	

6.4.3.12 Remote host IP address (AT+C1_CLI_IP1)

Command format	Parameters	Usage
AT+C1_CLI_IP1=<ip>\r\n	<ip>	Define new value
AT+C1_CLI_IP1?\r\n	Remote host IP address, default: 192.168.1.99	Query current value

Return value	[C1_CL_I_IP1] Value is: <ip>\r\nOK\r\n
---------------------	--

Remote host IP address command sets the IP address that communicates with WIZS2E module. This command will only available for TCP client and UDP mode.

6.4.3.13 Remote host port number (AT+C1_CL_I_PP1)

Command format	Parameters	Usage
AT+C1_CL_I_PP1=<port>\r\n	<port>	Define new value
AT+C1_CL_I_PP1?\r\n	Remote host port number, default: 5000	Query current value
Return value	[C1_CL_I_PP1] Value is: <port>\r\nOK\r\n	

Remote host port number command sets the port number that communicates with WIZS2E module. The value range is 0 to 65535 (Port 80 has used for web port. Please avoid using this port number.) This command will only available for TCP client and UDP mode.

6.4.3.14 DNS server address (AT+DNS)

Command format	Parameters	Usage
AT+DNS=<dns>\r\n	<dns>	Define new value
AT+DNS?\r\n	DNS server address, default: 114.114.114.114	Query current value
Return value	[DNS] Value is: <dns>\r\nOK\r\n	

DNS server address format is separate in 4 sections; each section is a decimal value and using a dot to separate. The value range for each section is 0-255 therefore the maximum value size for DNS server address is 15 bytes. This command could not accept xxx.xxx.xxx.0 or xxx.xxx.xxx.255 values input.

6.4.3.15 Debug message (AT+DEBUGMSGEN)

Command format	Parameters	Usage
AT+DEBUGMSGEN=<debugmsg>\r\n	<debugmsg>	Define new value
AT+DEBUGMSGEN?\r\n	0: Turn off the print debugging information; 1: Turn on print debug information (default)	Query current value
Return value	[DEBUGMEGEN] Value is: < debugmsg >\r\nOK\r\n	

6.4.3.16 Reconnecting time (AT+RECONTIME)

Command format	Parameters	Usage
AT+RECONTIME=<time>\r\n	<time>	Query current value
AT+RECONTIME?\r\n	Reconnecting time, default 0.	Query current value
Return value	[RECONTIME] Value is: <time>\r\nOK\r\n	

This command sets the waiting time for reconnecting TCP Server after the connection between the module and TCP Server is disconnected. This command is valid when the TCP Client is connected. The default value is 0, that is, reconnect immediately. The value range is 0 to 60000, unit: ms.

6.4.3.17 MAC address (AT+MAC)

Command format	Parameters	Usage
----------------	------------	-------

AT+MAC?\r\n	Nil	Query current value
Return value	[MAC] Value is: <mac>\r\nOK\r\n	

This is the MAC address of this W7500S2E. This attribute is read-only.

6.4.3.18 IP setting method (AT+IP_MODE)

Command format	Parameters	Usage
AT+IP_MODE=<mode>\r\n	<mode> 0: Static IP mode (default)	Define new value
AT+IP_MODE?\r\n	1: DHCP mode	Query current value
Return value	[IP_MODE] Value is: <mode>\r\nOK\r\n	

When using static IP mode, the IP address, gateway, subnet mask and DNS server address are required configure by user. In DHCP mode, W7500S2E-R1 will get all above IP parameters from the DHCP server.

6.4.3.19 Web port number (AT+WEB_PORT)

Command format	Parameters	Usage
AT+WEB_PORT=<port>\r\n	<port>	Define new value
AT+WEB_PORT?\r\n	Web server port number, default: 80	Query current value
Return value	[WEB_PORT] Value is: <port>\r\nOK\r\n	

This port number will be used on W7500S2E-R1's webserver through web browser. The value range is 0 to 65535. If the port wasn't set to 80, it needs to add the port number at the end of IP address. For example: 192.168.1.88: 8000.

Note: If W7500S2E-R1 works on TCP server mode, HTTP port should be the difference to the local port.

6.4.3.20 Remote host domain name (AT+DOMAIN)

Command format	Parameters	Usage
AT+DOMAIN=<domain>\r\n	<domain> Remote host domain name	Define new value
AT+DOMAIN?\r\n	default: www.iwiznet.cn	Query current value
Return value	[DOMAIN] Value is: <domain>\r\nOK\r\n	

This command sets the remote domain name, so please do not enter IP address format to this command. This command requires "AT+DNSEN" command to analysis DNS domain name. This command will only available on TCP client and UDP modes.

6.4.3.21 DNS enable (AT+DNSEN)

Command format	Parameters	Usage
AT+DNSEN=<dns>\r\n	<dns> 0: Disable DNS function (default)	Define new value
AT+DNSEN?\r\n	1: Enable DNS function	Query current value

Return value	[DNSEN] Value is: <dns>\r\nOK\r\n
---------------------	-----------------------------------

After enable DNS function, W7500S2E-R1 can use remote host through domain name. Every time the module has power up, it activates DNS function. This command will only available on TCP client and UDP modes.

6.4.3.22 Reconnect time (AT+RECONTIME)

Command format	Parameters	Usage
AT+RECONTIME=<time>\r\n	<time>	Define new value
AT+RECONTIME?\r\n	Reconnect time, default: 0	Query current value
Return value	[RECONTIME] Value is: <time>\r\nOK\r\n	

This command configures to limit the time of the TCP client waiting for reconnection the module has disconnected from a TCP server. This command will only available on TCP client mode. Default value is 0 for direct reconnection. Value range is 0 to 60,000. Unit: ms.

6.4.3.23 NetBIOS (AT+NETBIOS)

Command format	Parameters	Usage
AT+NETBIOS=<netbios>\r\n	<netbios> 0: Disable NetBIOS function (default)	Define new value
AT+NETBIOS?\r\n	1: Enable NetBIOS function	Query current value
Return value	[NETBIOS] Value is: <netbios>\r\n	

NetBIOS protocol can provide LAN device naming service. After enable NetBIOS function, user could use web browser to search the module by entering "http://[DeviceName]" for visiting WIZS2E module configuration web page.

Note: To use this function, [DeviceName] can be a combination of letters, numbers, the hyphen "-" and the underscore "_". It can not be all numbers and can not be the same with other devices, and the length is not more than 15 bytes

6.4.4 Serial control command

6.4.4.1 Baud Rate (AT+C1_BAUD)

Command format	Parameters	Usage
AT+C1_BAUD=<baud>\r\n	<baud> 0: 300; 1: 600; 2: 1200; 3: 2400; 4: 4800; 5: 9600; 6: 14400; 7: 19200; 8: 38400; 9: 56000; 10: 57600; 11: 115200 (Default); 12: 128000; 13: 230400; 14: 256000; 15: 460800	Define new value
AT+C1_BAUD?\r\n		Query current value
Return value	[C1_BAUD] Value is: <baud>\r\n	

6.4.4.2 Data bit (AT+C1_DATA)

Command format	Parameters	Usage
AT+C1_DATA=<data>\r\n	<data> 0: 7 bit	Define new value

AT+C1_DATAB?\r\n	1: 8 bit (default)	Query current value
Return value	[C1_DATAB] Value is: <datab>\r\n	

6.4.4.3 Stop bit (AT+C1_STOPB)

Command format	Parameters	Usage
AT+C1_STOPB=<stopb>\r\n	<stopb>	Define new value
AT+C1_STOPB?\r\n	0: 1 bit (default) 1: 2 bit	Query current value
Return value	[C1_STOPB] Value is: <stopb>\r\n	

6.4.4.4 Paritybit (AT+C1_PARITY)

Command format	Parameters	Function value
AT+C1_PARITY=<parity>\r\n	<parity>	Define new value
AT+C1_PARITY?\r\n	0: none (default) 1: Odd 2: Even	Query current value
Return value	[C1_PARITY] Value is: <parity>\r\n	

6.4.4.5 Serial flow control (AT+C1_SER_C)

Command format	Parameters	Usage
AT+C1_SER_C=<c>\r\n	<c>	Define new value
AT+C1_SER_C?\r\n	0: None (default) 1: Hardware flow control	Query current value
Return value	[C1_SER_C] Value is: <c>\r\n	

This command activates the hardware flow control. This could improve the data accuracy for high speed transmission. Note: If turn on this function, the counter serial device also need to turn on this function.

6.4.4.6 Clear serial buffer if connect (AT+C1_BUF_CLS)

Command format	Parameters	Usage
AT+C1_BUF_CLS=<class>\r\n	<cls>	Define new value
AT+C1_BUF_CLS?\r\n	0: Do not clear the serial port buffer after establishing connection (default) 1: Clear data in serial buffer after establishing connection	Query current value
Return value	[C1_BUF_CLS] Value is: <cls>\r\n	

If there is disconnection during data communication, serial buffer may still contain data which haven't send out. This command could handle usage of those remaining data in serial interface after reconnection.

6.4.4.7 Data packaging size (AT+C1_SER_LEN)

Command format	Parameters	Usage
AT+C1_SER_LEN=<len>\r\n	<len> The length of the data package, value range: 0 ~ 2048 bytes, default: 0 (Disable data packaging by size)	Define new value
AT+C1_SER_LEN?\r\n		Query current value
Return Value	[C1_SER_LEN] Value is: <len>\r\n	

When receiving data from serial port, this value defined the length of single data package each time.

6.4.4.8 Data packaging time (AT+C1_SER_T)

Command format	Parameters	Usage
AT+C1_SER_T=<time>\r\n	<time> Data packaging by time, value range: 0 ~ 60000, unit: ms; default: 0 (disable data packaging by time)	Define new value
AT+C1_SER_T?\r\n		Query current value
Return value	[C1_SER_T] Value is: <time>\r\n	

When receiving data from serial port, this value defined the time frame for sending the data in buffer.

6.4.4.9 Inactivity timer (AT+C1_IT)

Command format	Parameters	Usage
AT+C1_IT=<time>\r\n	<time> Inactivity time to disconnect, value range 0 ~ 60000, unit: ms, default: 0 (Disable this function)	Define new value
AT+C1_IT?\r\n		Query current value
Return value	[C1_IT] Value is: <time>\r\n	

When the module is working in TCP server or client mode, there has a chance that opponent device will disconnect with the module (forcibly disconnected or network failure). However, the module may not notify the disconnection occur and still maintain the connection active status. Then, there will be a failure when either party initiates the communication. By defining an inactivity timer for the module, connection will be disconnected if the module didn't receive any data in a defined time. When the value of inactivity timer is 0, it will be disable and the connection will maintain active all the time.

6.4.4.10 Keep alive timer (AT+C1_TCPAT)

Command format	Parameters	Function feature
AT+C1_TCPAT=<time>\r\n	<time> Keep alive time, value range: 0 ~65535, unit: 5s; default: 0 (disable this function)	Define new value
AT+C1_TCPAT?\r\n		Query current value
Return value	[C1_TCPAT] Value is: <time>\r\n	

Under TCP server mode, the module will send out a keep alive package in a standard of time to check the connection is it active. If the module did not receive any response, it will disconnect the connection.

6.4.4.11 TCP authentication (AT+C1_LINK_P)

Command format	Parameters	Usage
AT+C1_LINK_P=<pass>\r\n	<pass> 0: No password is required for TCP connection	Define new value
AT+C1_LINK_P?\r\n	1: Required password for TCP connection	Query current value
Return value	[C1_LINK_P] Value is: <time>\r\n	

To improve security of communication, the module supports TCP authentication. When TCP authentication is enable, the module requires password input from the Ethernet. If the password is wrong, it requires re-entering password until it receives a correct password. Device password could be configured or query by “AT+PASS”.

6.4.4.12 TCP link establishment condition (AT+LINK_T)

Command format	Parameters	Usage
AT+C1_LINK_T=<link_t>\r\n	<link_t> 0: Reconnect after power up the module (default)	Define new value
AT+C1_LINK_T?\r\n	1: Reconnect after received data from serial interface	Query current value
Return value	[C1_LINK_T] Value is: <link_t>\r\n	

In TCP client mode, the connection is established by the module. If define it as 1, the module will establish the connection establishment by receiving the first package of data from serial interface. This data will be discard by the module. The actual data will be started from the second package that received from the serial interface.

6.4.4.13 TCP link establishment message (AT+C1_LINK_M)

Command format	Parameters	Usage
AT+C1_LINK_M=<link_m>\r\n	<link_m> 0: No message (default)	Define new value
AT+C1_LINK_M?\r\n	1: Send Device ID 2: Send MAC address 3: Send IP address	Query current value
Return value	[C1_LINK_M] Value is: <link_m>\r\n	

Only operate on TCP communication, it will send out device message after the connection established.

6.4.4.14 bytes sent by serial (AT+C1_SEND_NUM)

Command format	Parameters	Usage
AT+C1_SEND_NUM?\r\n	Nil	Query the bytes sent by serial interface
Return value	<C1_SEND_NUM> Value is: <num>\r\nOK\r\n	

Maximum value: 4,294,967,295 bytes

6.4.4.15 Serial interface receive counter (AT+C1_RCV_NUM)

Command format	Parameters	Usage
AT+C1_RCV_NUM?\r\n	Nil	Query the bytes received by serial interface
Return value	<C1_RCV_NUM> Value is: <num>\r\nOK\r\n	

Maximum value: 4,294,967,295 bytes.

6.5 AT command configuration examples

6.5.1 Set into TCP server mode example

```

AT\r\n                                     //Terminal check
OK\r\n
AT+ECHO=1\r\n                             //Echo ON
[ECHO] Value is:1\r\n
AT+CI_OP=0\r\n                             //Operating mode in TCP server
[CI_OP] Value is:0\r\n
OK\r\n
AT+IP_MODE=0\r\n                           //Set into static IP mode
[IP_MODE] Value is:0\r\n
OK\r\n
AT+IP=192.168.1.88\r\n                     //Set local IP address
[IP] Value is:192.168.1.88\r\n
OK\r\n
AT+CI_PORT=5000\r\n                         //Set the local port number
[CI_PORT] Value is:5000\r\n
OK\r\n
AT+EXIT\r\n                                 //Save the settings and switch to data mode

```

6.5.2 TCP client mode example

```
AT\r\n //Terminal check
OK\r\n
AT+ECHO=1\r\n //ECHO "ON"
[ECHO] Value is:1\r\n
AT+CI_OP=1\r\n //Operating mode in TCP Client mode
[CI_OP] Value is:1\r\n
OK\r\n
AT+IP_MODE=1\r\n //Set into DHCP mode
[IP_MODE] Value is:1\r\n
OK\r\n
AT+CI_PORT=5000\r\n //Set the local port number
[CI_PORT] Value is:5000\r\n
OK\r\n
AT+CI_CLI_IP1=192.168.1.99\r\n //Set the remote host IP address
[CI_CLI_IP1] Value is:192.168.1.99\r\n
OK\r\n
AT+CI_CLI_PP1=5000\r\n //Set the remote host port number
[CI_CLI_PP1] Value is:5000\r\n
OK\r\n
AT+EXIT\r\n //Save the settings and switch to data mode
```

6.5.3 UDP mode example

```
AT\r\n //Terminal Check
OK\r\n
AT+ECHO=1\r\n //Echo ON
[ECHO] Value is:1\r\n
AT+CI_OP=2 \r\n //Operating mode in UDP mode
[CI_OP] Value is:2\r\n
OK\r\n
AT+IP_MODE=1\r\n //Set into DHCP mode
[IP_MODE] Value is:1\r\n
OK\r\n
AT+CI_PORT=5000\r\n //Set local port number
[CI_PORT] Value is:5000\r\n
OK\r\n
AT+CI_CLI_IP1=192.168.1.99\r\n //Set remote host IP address
[CI_CLI_IP1] Value is:192.168.1.99\r\n
OK\r\n
AT+CI_CLI_PP1=5000\r\n //Set remote host Port number
[CI_CLI_PP1] Value is:5000\r\n
OK\r\n
AT+EXIT\r\n //Save the settings and switch to data mode
```

7 Web page configuration

WIZS2E module support web page configuration, it is recommended to use browsers including Internet Explorer 11, Chrome and Firefox. For other browsers, it may display or working improperly. The below example is using the Chrome browser.

Before using the web page configuration, you need to make sure that W7500S2E-R1 can be accessed correctly, that is, if you are configuring within the local area network, W7500S2E-R1 needs to be on the same network segment as the computer, and if you are remotely configured, you need to port-map W7500S2E-R1 to the public network IP. The following is a local area network example configuration, the configuration method is described below.

7.1 Main page

Starting the Chrome browser, input the IP address of WIZS2E module into address bar. Factory default: 192.168.1.88. Figure 7-1 shows the login page.

Figure 7-1 Login page

The default password is “admin”, click login button to enter the W7500S2E-R1 configuration main page. Please know that the time session for the W7500S2E-R1 webserver is 5 minutes. If over 5 minutes of inactivity, re-login is required.

Figure 7-3 shows the basic information for the web page. To exit the site, please press “Logout” that shows on the right top corner of the web page.

This page shows the basic information of the WIZS2E module. It is separate into four sections; the following paragraph talking about each section.

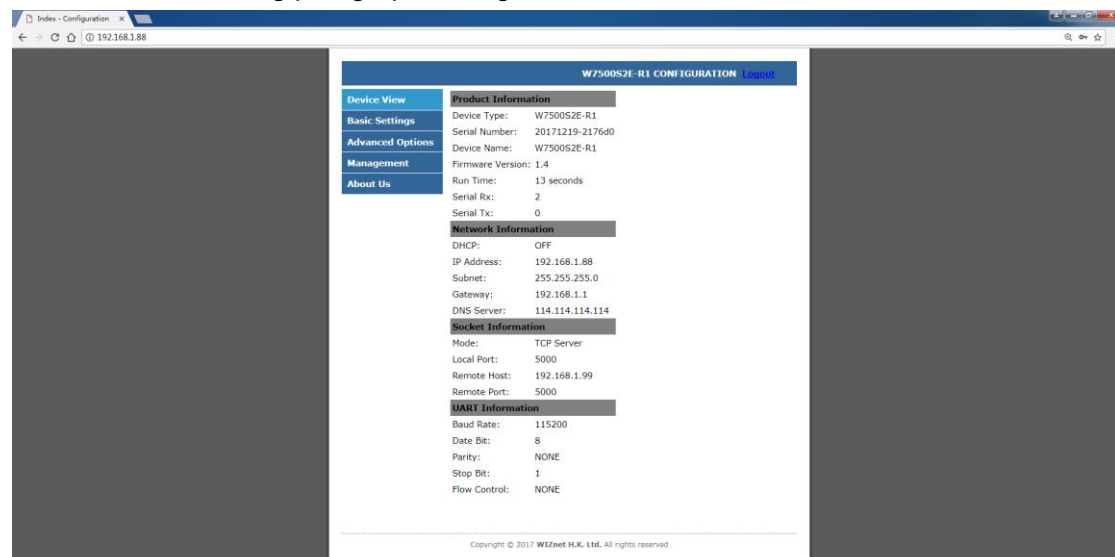

Figure 7-3 Basic information page

Product Information

- Device Type: factory default is W7500S2E-R1, cannot be modified.
- Device Name: name of module, the factory default is W7500S2E-R1 and it could

be changed from the advanced setting page

- Firmware Version: shows the firmware version
- Serial number: the last 3 parts of the serial number will be equal to the last 6 characters of the MAC address of the module
- Temperature: Shows 0°c degree, reserved function
- Run Time: W7500S2E-R1's operation time. Unit: seconds
- Serial Rx: Shows the bytes of data received at the serial interface
- Serial Tx: Shows the bytes of data sent from the serial interface

Network Information

- DHCP: on/off; Shows the DHCP mode is it active, default: off *
- IP Address: Shows the current IP address, default: 192.168.1.88 *
- Subnet: Shows the current subnet mask, default: 255.255.255.0 *
- Gateway: Shows the current gateway, default: 192.168.1.1 *
- DNS Server: Shows the current DNS address, default: 114.114.114.114 *

Socket Information

- Mode: Shows the operating mode, default: TCP Server *
- Local Port: Shows the local port, default: 5000 *
- Remote Host: Shows the Remote Host IP address, default: 192.168.1.99 *
- Remote Port: Shows the Remote Host Port number, default: 5000 *

UART Information

- Baud Rate: Shows the baud rate, default: 115200 *
- Data Bit: Shows the data bit, default: 8 *
- Parity: Shows the parity bit, default: NONE *
- Stop Bit: Shows the stop bit, default: 1 *
- Flow Control: Shows the flow control settings, default: NONE *

* These settings could be updated in the "Basic Settings"

7.2 Basic Settings

Figure 7-4 shows W7500S2E-R1 basic settings page. It is separate into four sections; The following paragraph talking about each section.

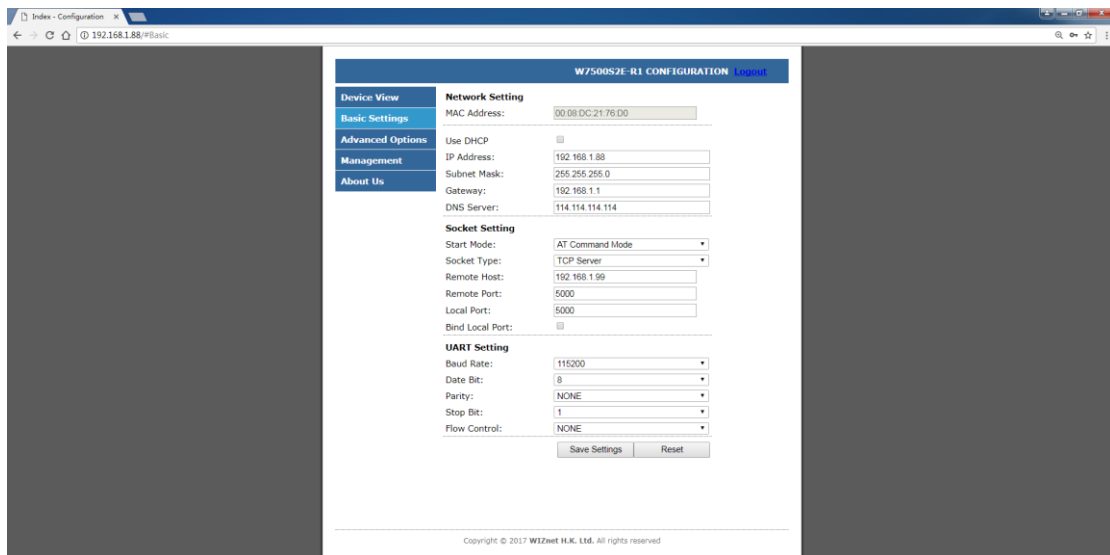

Figure 7-4 Basic setting page

Network Setting

- MAC Address: Shows MAC address provided with the module, user cannot modify
- Use DHCP: DHCP mode option, default: uncheck #
- IP address: Shows the IP address, default: 192.168.1.88 #
- Subnet Mask: Shows the Subnet Mask, default: 255.255.255.0 #
- Gateway: Shows the Gateway, default: 192.168.1.1 #
- DNS Server: Shows the DNS address, default: 114.114.114.114 #

Socket Setting

- Start Mode: Startup mode of the module, it could be “AT Command Mode” or “Data Mode” #
- Socket Type: The module’s operating mode: There are 3 types to use. TCP server, TCP client and UDP mode
- Remote Host: Shows remote host IP address, default: 192.168.1.99; It accepts IP address or domain name inputs #
- Remote Port: Shows remote host port number, default: 5000 #
- Local Port: Local port number, default: 5000. The value range is 0 to 65535 (Port 80 has used for web port. Please avoid using this port number.) #
- Bind Local Port: Binding Local Port option, default: uncheck, only available on TCP client mode #

UART Setting

- Baud Rate: The baud rate option, default: 115200, between 1.2Kps to 1.152Mbps #
- Data Bit: The data bit option, default: 8, it could set into 7 or 8 bits #
- Parity: The parity bit option, default: 8, it could set into NONE, ODD or EVEN #
- Stop Bit: The stop bit option, default: 1, it could set into 0.5, 1, 1.5 or 2 bits #
- Flow Control: Shows the flow control option, default is NONE, it could set into NONE or “CTS/RTS mode” #

User configurable

Save Settings: The button to save all these settings, it shows a prompt window with “Success saved!” message.

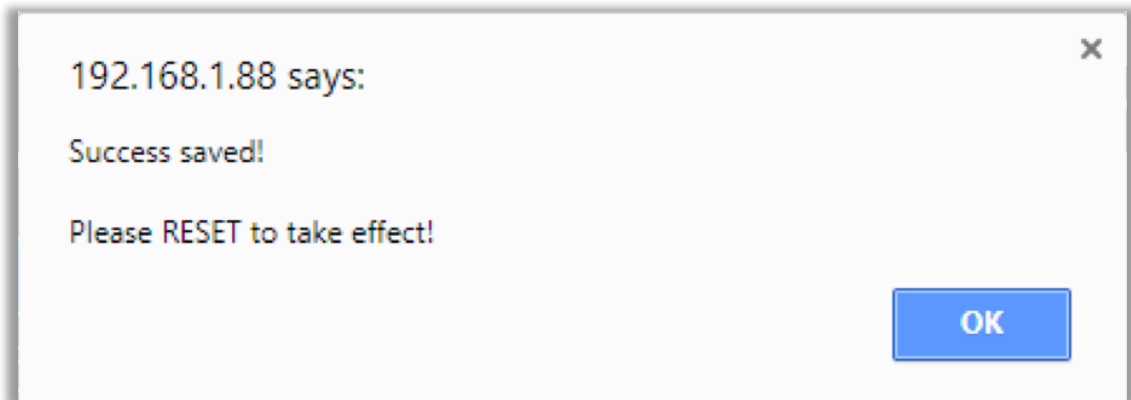

Figure 7-5 Web page prompt - Save Success

Reset: Reset button, if the user doesn't need to configure on advanced settings, please press the OK button for reset the module; after reset, the saved settings will be activated.

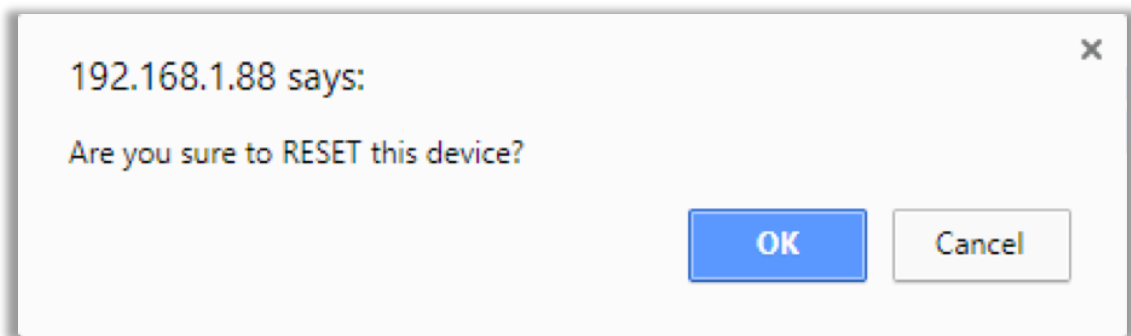

Figure 7-6 Web page prompt - reset

7.3 Advance Settings

Figure 7-7 shows the advance settings page of WIZS2E module.

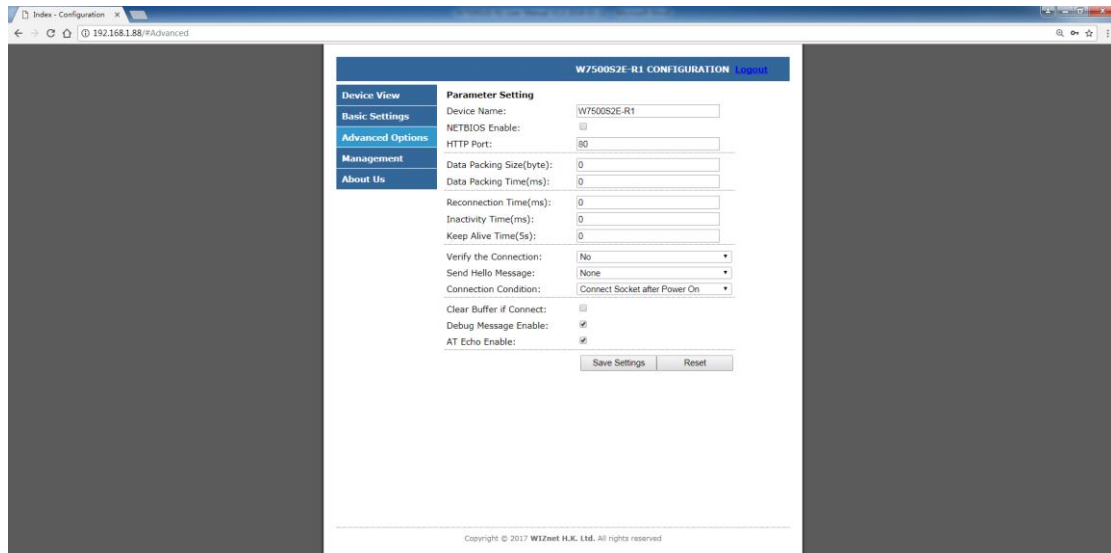

Figure 7-7 Basic setting page

Device Name: The device name, default: W7500S2E-R1, user could make its own definition, it could be any characters, Maximum 16 bit

NETBIOS Enable: NetBIOS option, click the NetBIOS to activate this feature, default: disable; if activated, user could type W7500S2E-R1 (case insensitive) in the browser to login to the webserver of this module. For more information, please refer 6.4.3.20 section.

HTTP Port: W7500S2E-R1's web server port number, default: 80, The value range is 0 to 65535. If the port wasn't set to 80, then need to input the port at the end of IP address. For example: 192.168.1.88: 8000.

Note: If W7500S2E-R1 works in TCP server mode, HTTP port must not be set to the same as the local port of the module.

Data Packing Size (byte): Data packaging length, default: 0 (disable), maximum size: 2048 bytes.

Data Packing Time (ms): Data packaging time, default: 0 (disable), maximum size: 2048 bytes.

Reconnection Time (ms): Set the time for reconnection, only available in TCP client mode, default: 0 (instant reconnection), value range: 0 to 60000, unit: ms

Inactivity Time (ms): Set the inactivity timer, only available on TCP modes, value range: 0 ~ 60000, unit: ms, default: 0 (disable)

Keep Alive Time (5s): Set the Keep alive timer, only available on TCP modes, value range: 0 ~ 65536, unit: 5s, default: 0 (disable)

Verify the Connection: When the user created a communication in TCP protocol and this command was enable, the module requires a password confirmation from the Ethernet side. If the password is wrong, it requires re-entering password until it receives a correct password. Default: No (disable)

Send Hello Message: Connected message input, only available on TCP modes, user could choose "None" for no message send (default), "Send Device Name" to send device name, "Send MAC address" to send device's MAC address or "Send IP address" to send

device IP address

Connection Condition: In TCP client mode, the connection is starts from W7500S2E-R1. This function can set as “Connect socket after power up” (Default) or “Connect socket after UART received data”

Clear Buffer if Connect: If a disconnection has created in the period of data communication, serial buffer may still contain some data that didn’t send out. After the module has reconnect with the remote host, this command could handle usage of those remaining data in serial interface. default: uncheck (disable)

Debug Message Enable: Shows debug message information, default: checked (enable).

AT Echo Enable: Echo means W7500S2E module could directly return the input values to the serial interface. Thus, this option may help some users working more easily through serial terminal software. However, this may cause trouble if the serial is connected to an embedded system. Turning off this function may help. Default: checked (enable)

7.4 Device management

Clicking “Management” to get into device management page as figure 7-9, this page contains 2 sections.

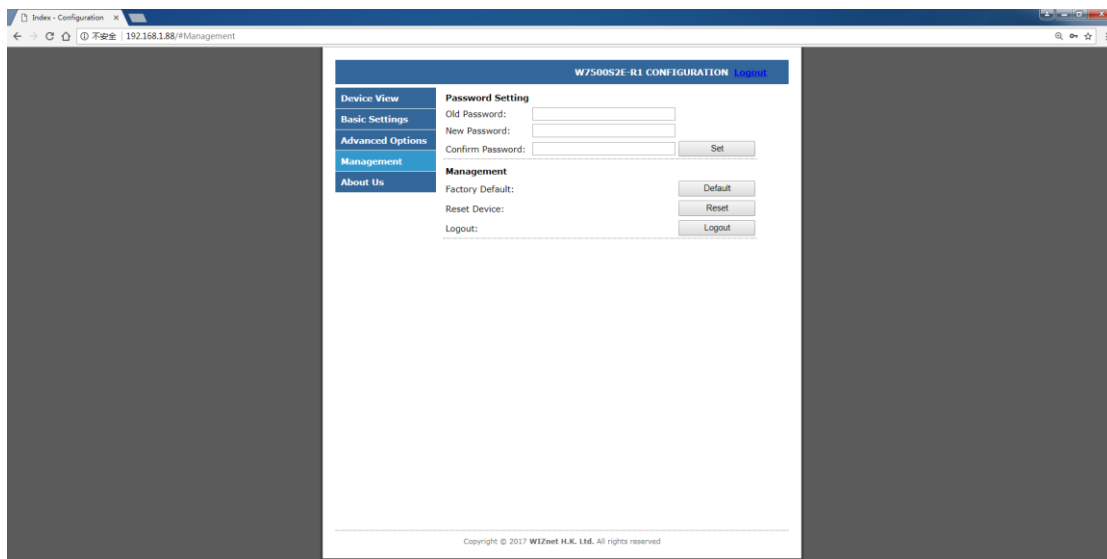

Figure 7-9 device management page

Password setting

Old Password: the old password, default: admin

New Password: Enter new password, maximum for 16 bytes, it needs to be numbers, alphabets or the combination of both. It does not accept blank as input value.

Confirm Password: Re-enter the new password

Set: Submit button for renewing password, when current password and the new passwords are correct, it shows a prompt window for password changed confirmation.

Please check “OK” and back to login page.

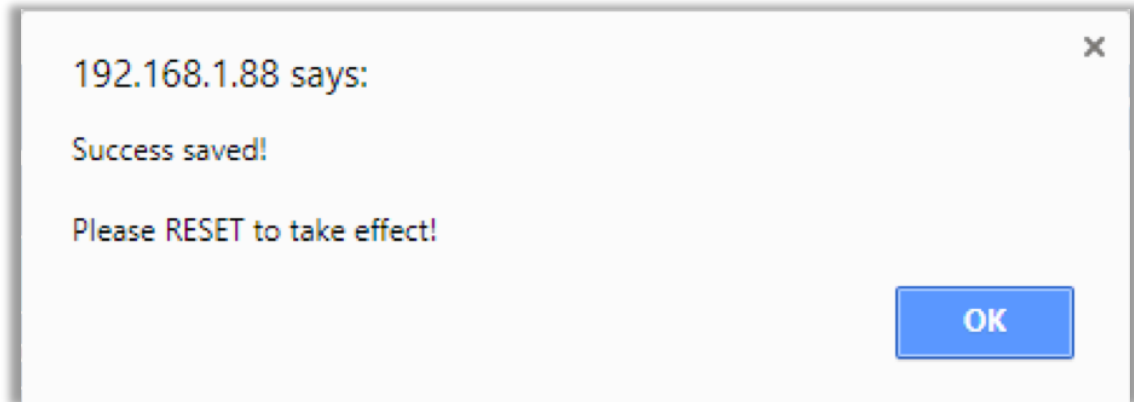

Figure 7-10 Web page prompt - device password modification successful

Management

Factory Default: factory reset button, pressing this button will activate factory reset procedure. It shows a prompt window for re-confirmation is procedure, please click "OK" for factory reset procedure and back to login page.

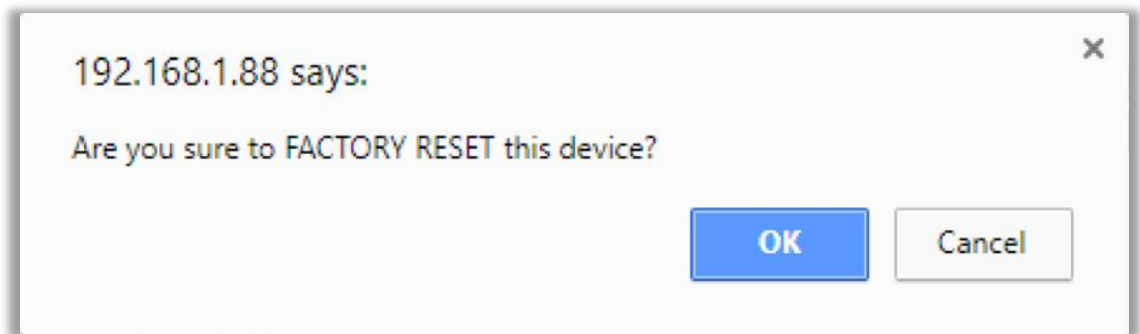

Figure 7-11 Prompt - Factory reset

Reset Device: Reset the module

Logout: Logout from session

8 Firmware Upgrade

W7500S2E-R1 supports configuration tools and remote web page firmware upgrade. This two types of upgrades are easy to use; the following information shows the firmware upgrade in both methods.

Note: the following firmware **MUST** be official W7500S2E-R1 firmware from WIZnet H.K. Limited in binary format.

8.1 W7500S2E-R1 firmware upgrade through ConfigTool

Firstly, the IP address for the module needs to be in the same network segment with the host computer. Open serial terminal to check on the upgrading process. Search the module and click “Upload Firmware” button and choose the related Firmware as figure 8-1 shows.

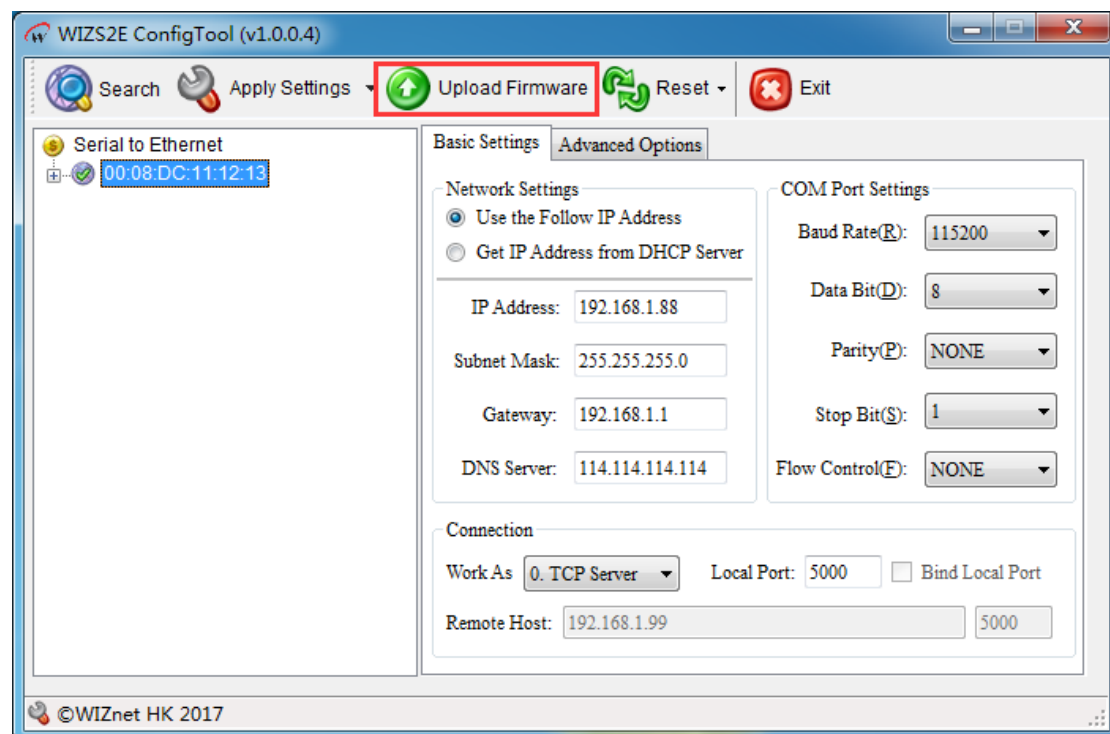

Figure 8-1 W7500S2E-R1 firmware upgrade through ConfigTool

Figure 8-2 shows the firmware upgrade progress has finished.

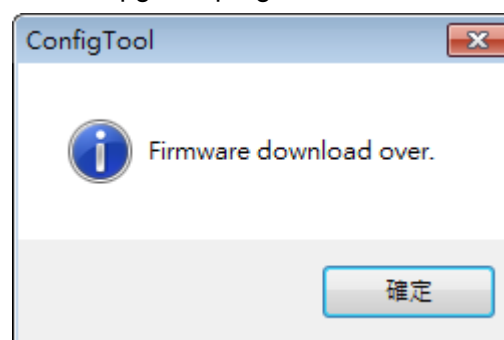

Figure 8-2 host computer prompt - Firmware upgrade complete

Disclaimers

WIZNET H.K. LIMITED and its subsidiaries (“WIZnet”) reserve the right to make changes, corrections, enhancements, modifications, and improvements to WIZnet products and/or to this document at any time without notice. Purchasers should obtain the latest relevant information on WIZnet products before placing orders. WIZnet products are sold pursuant to WIZnet’s terms and conditions of sale in place at the time of order acknowledgement. Purchasers are solely responsible for the choice, selection, and use of WIZnet products and WIZnet assumes no liability for application assistance or the design of Purchasers’ products. No license, express or implied, to any intellectual property right is granted by WIZnet herein. Resale of WIZnet products with provisions different from the information set forth herein shall void any warranty granted by WIZnet for such product. WIZnet and the WIZnet logo are trademarks of WIZnet. All other product or service names are the property of their respective owners. Information in this document supersedes and replaces information previously supplied in any prior versions of this document

© 2017 WIZNET H.K. LIMITED – All rights reserved