

Precision Current Shunt Meter

PCS-1000

USER MANUAL

GW INSTEK PART NO. 82CS-1K000EB1



ISO-9001 CERTIFIED MANUFACTURER

GW INSTEK

This manual contains proprietary information, which is protected by copyright. All rights are reserved. No part of this manual may be photocopied, reproduced or translated to another language without prior written consent of Good Will company.

The information in this manual was correct at the time of printing. However, Good Will continues to improve products and reserves the rights to change specification, equipment, and maintenance procedures at any time without notice.

Good Will Instrument Co., Ltd.
No. 7-1, Jhongsing Rd., Tucheng Dist., New Taipei City 236, Taiwan.

Table of Contents

SAFETY INSTRUCTIONS	4
GETTING STARTED	8
PCS-1000 Overview	9
Appearance	11
OPERATION	18
Set Up	19
Basic Operation	25
COMMUNICATION INTERFACE	42
Interface Configuration	44
Command Syntax	56
Command List	59
Status Registers	86
Error Messages	87
APPENDIX	88
PCS Default Settings	88
LED ASCII Table Character Set	88
PCS-1000 Specifications	89
PCS Dimensions	91
Declaration of Conformity	92
INDEX	93

S SAFETY INSTRUCTIONS

This chapter contains important safety instructions that you must follow during operation and storage. Read the following before any operation to insure your safety and to keep the instrument in the best possible condition.

Safety Symbols

These safety symbols may appear in this manual or on the instrument.



WARNING

Warning: Identifies conditions or practices that could result in injury or loss of life.



CAUTION

Caution: Identifies conditions or practices that could result in damage to the instrument or to other properties.



DANGER High Voltage



Attention Refer to the Manual



Protective Conductor Terminal



Earth (ground) Terminal



Do not dispose electronic equipment as unsorted municipal waste. Please use a separate collection facility or contact the supplier from which this instrument was purchased.

Safety Guidelines

General Guideline



CAUTION

- Do not place any heavy object on the instrument.
- Avoid severe impact or rough handling that leads to damaging the instrument.
- Do not discharge static electricity to the instrument.
- Use only mating connectors, not bare wires, for the terminals.
- Do not block the cooling fan opening.
- Do not disassemble the instrument unless you are qualified.

(Measurement categories) EN 61010-1:2001 specifies the measurement categories and their requirements as follows. The instrument falls under category II (600VAC).

- Measurement category IV is for measurement performed at the source of low-voltage installation.
- Measurement category III is for measurement performed in the building installation.
- Measurement category II is for measurement performed on the circuits directly connected to the low voltage installation.
- Measurement category I is for measurements performed on circuits not directly connected to Mains.

Power Supply



WARNING

- AC Input voltage range: 100V/120V/220V/240V $\pm 10\%$ (selectable range)
- Frequency: 50/60Hz
- To avoid electrical shock connect the protective grounding conductor of the AC power cord to an earth ground.

Cleaning the Instrument

- Disconnect the power cord before cleaning.
 - Use a soft cloth dampened in a solution of mild detergent and water. Do not spray any liquid.
 - Do not use chemicals containing harsh material such as benzene, toluene, xylene, and acetone.
-

Operation Environment

- Location: Indoor, no direct sunlight, dust free, almost non-conductive pollution (Note below)
- Relative Humidity: Full accuracy to 80% RH, at 40°C
- Altitude: < 2000m
- Temperature: 0°C to 50°C

(Pollution Degree) EN 61010-1:2001 specifies the pollution degrees and their requirements as follows. The instrument falls under degree 2.

Pollution refers to “addition of foreign matter, solid, liquid, or gaseous (ionized gases), that may produce a reduction of dielectric strength or surface resistivity”.

- Pollution degree 1: No pollution or only dry, non-conductive pollution occurs. The pollution has no influence.
 - Pollution degree 2: Normally only non-conductive pollution occurs. Occasionally, however, a temporary conductivity caused by condensation must be expected.
 - Pollution degree 3: Conductive pollution occurs, or dry, non-conductive pollution occurs which becomes conductive due to condensation which is expected. In such conditions, equipment is normally protected against exposure to direct sunlight, precipitation, and full wind pressure, but neither temperature nor humidity is controlled.
-

Storage environment

- Location: Indoor
 - Temperature: -40°C to 70°C
 - Relative Humidity: <90%
-

Disposal

Do not dispose this instrument as unsorted municipal waste. Please use a separate collection facility or contact the supplier from which this instrument was purchased. Please make sure discarded electrical waste is properly recycled to reduce environmental impact.

Power cord for the United Kingdom

When using the instrument in the United Kingdom, make sure the power cord meets the following safety instructions.

NOTE: This lead/appliance must only be wired by competent persons



WARNING: THIS APPLIANCE MUST BE EARTHED

IMPORTANT: The wires in this lead are coloured in accordance with the following code:

Green/ Yellow:	Earth
Blue:	Neutral
Brown:	Live (Phase)



As the colours of the wires in main leads may not correspond with the coloured marking identified in your plug/appliance, proceed as follows:

The wire which is coloured Green & Yellow must be connected to the Earth terminal marked with either the letter E, the earth symbol \oplus or coloured Green/Green & Yellow.

The wire which is coloured Blue must be connected to the terminal which is marked with the letter N or coloured Blue or Black.

The wire which is coloured Brown must be connected to the terminal marked with the letter L or P or coloured Brown or Red.

If in doubt, consult the instructions provided with the equipment or contact the supplier.

This cable/appliance should be protected by a suitably rated and approved HBC mains fuse: refer to the rating information on the equipment and/or user instructions for details. As a guide, a cable of 0.75mm² should be protected by a 3A or 5A fuse. Larger conductors would normally require 13A types, depending on the connection method used.

Any exposed wiring from a cable, plug or connection that is engaged in a live socket is extremely hazardous. If a cable or plug is deemed hazardous, turn off the mains power and remove the cable, any fuses and fuse assemblies. All hazardous wiring must be immediately destroyed and replaced in accordance to the above standard.

GETTING STARTED

This chapter describes the instrument in a nutshell, including its main features and front / rear panel introduction.



PCS-1000 Overview	9
Main Features	9
Accessories	10
 Appearance	 11
Front Panel	11
Rear Panel	16

PCS-1000 Overview

The PCS-1000 uses five high-precision shunt resistors as the basis for accurate current and voltage measurements. The 5 shunt ranges are 0.001 Ω , 0.01 Ω , 0.1 Ω , 1 Ω , 10 Ω with a current measurement range of 300A, 30A, 3A, 300mA and 30mA, respectively.

Main Features

- | | |
|-------------|---|
| Performance | <ul style="list-style-type: none">• Wide DC/AC voltage range (200mV ~ 600VAC/1000VDC)• Wide AC/DC current range (30mA ~ 300A)• Low drift at all ranges• Low temperature coefficients |
|-------------|---|
-

- | | |
|----------|--|
| Features | <ul style="list-style-type: none">• Shunts: 0.001Ω, 0.01Ω, 0.1Ω, 1Ω, 10Ω• Current Meter (6 1/2 digits current meter)• Voltage Meter (6 1/2 digits voltage meter)• Current Monitor• Voltage and current can be measured at the same time. |
|----------|--|
-

- | | |
|-----------|--|
| Interface | <ul style="list-style-type: none">• USB• GPIB for SCPI commands |
|-----------|--|

Accessories

Standard Accessories	Part number	Description
	Region dependant	User manual
	Region dependant	Power cord
	GTL-105A	Alligator clip test leads (3A max): 1x red, 1x black
	GTL-207	Banana plug test leads: 1x red, 1x black
	GTL-240	USB Cable
	PCS-001	Basic Accessory Kit: Bolt HMS M8*16 x2 Nut hexagon M8*0.75P x2 Spring washer M8 8.4*13.7*1.5T x2 Plain washer M8 8.4*16*1.6T x2
Optional Accessories	Part number	Description
	GRA-419-J	Rack mount adapter (JIS)
	GRA-419-E	Rack mount adapter (EIA)

Appearance

Front Panel

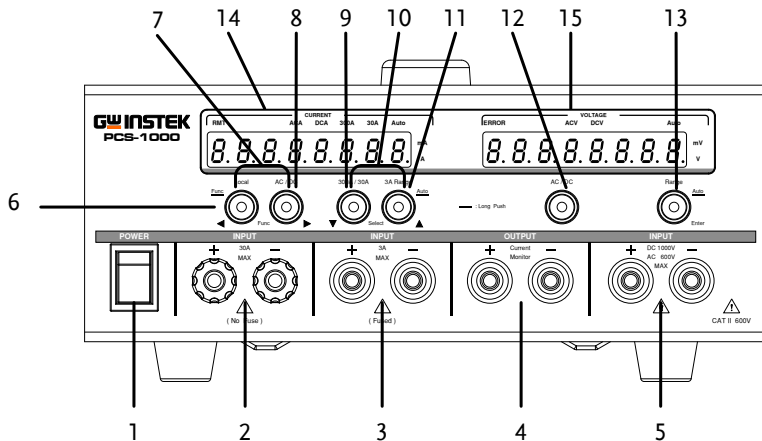

1. Power Switch

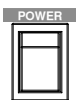

Turn on or off the main power.

2. AC/DC 30A Terminal

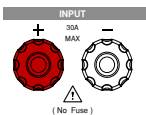

Accepts DC/AC. 30A maximum current input.

Warning: The maximum voltage difference between the negative terminal and earth cannot exceed 500V peak.

3. AC/DC 3A Terminal

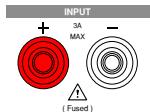

Accepts DC/AC. 3A maximum current input. Internally, there is a fuse which protects the instrument from over current:

Fuse Rating: T3.5A, 600V

 Note: If the fuse is damaged, please contact your dealer or a GW Instek service center to replace the fuse.

 Warning: The maximum voltage difference between the negative terminal and earth cannot exceed 500V_{peak}.

4. Current Monitor Sensor

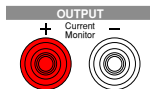

Current Monitor Output.

Range 0~300mV (0~full scale of selected input range).

5. AC/DC Voltage Terminal

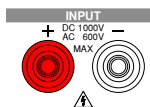

Accepts DC 1000V or AC 600V maximum voltage input.

 Warning: The maximum voltage difference between the negative terminal and earth cannot exceed 500V_{peak}.

6. Local

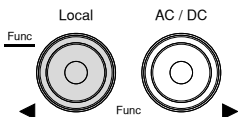

Local: Press to switch to local mode.

Func
(long push)

Func: Long push to enter the Function menu. The Function menu is used to configure the instrument.

7. ◀ Func ▶

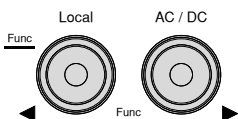

Use the Func arrows keys to scroll through each function when in the Function menu.

8. AC/DC
(Current)

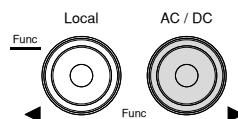

Selects DC or AC current measurement.

9. 300A/30A



Manually select the 300A or 30A measurement range.

10. ▼ Select ▲

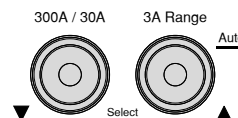

Use the Select arrow keys to edit parameter values when in the Function menu.

11. 3A Range

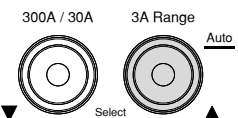

3A Range: Manually Select the 30mA, 300mA, or 3A measurement range.

Auto
(long push)

Auto: Long push to automatically select 30mA, 300mA or 3A measurement ranges.

12. AC/DC
(Voltage)



Selects DC or AC voltage measurement.

13. Range

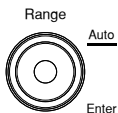

Manually select the voltage measurement range:
 DC: 200mV, 2V, 20V, 200V, 1000V
 AC: 200mV, 2V, 20V, 200V, 600V

Enter

Secondary function that confirms selections when in the Function menu.

Auto
(long push)

Voltage auto range.

14. Current Meter

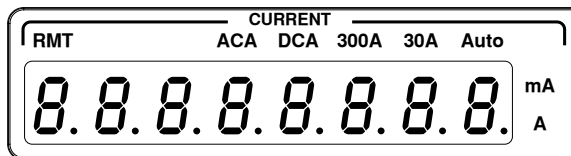

Displays current measurement.

RMT	The RMT icon will turn on when the instrument is in remote mode.
ACA	AC current measurement mode indicator.
DCA	DC current measurement mode indicator.
300A	300A measurement range indicator. Equivalent to choosing the rear panel 300A terminal.
30A	30A measurement range indicator. Equivalent to choosing the front panel 30A terminal.

Auto	Autorange indicator for the 30mA, 300mA and 3A ranges. If the Autorange indicator is off, then that indicates that the range has been manually selected.
mA	Milliamp unit indicator.
A	Ampere unit indicator.

15. Voltage Meter

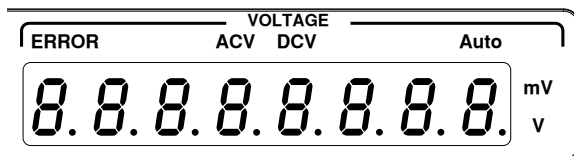

Displays voltage measurement.

ERROR	Indicates an interface error. The SYSTem:ERRor? query can be used to read back error messages. See page 87 and 74 for details.
ACV	AC voltage measurement mode indicator.
DCV	DC voltage measurement mode indicator.
Auto	Autorange indicator. If the Auto indicator is off, then that indicates that the range has been manually selected.
mV	Millivolt unit indicator.
V	Volt unit indicator.



Warning:

For the 3A, 30A and 300A terminals on the front and rear panels, the maximum voltage difference between the negative terminal and earth cannot exceed 500Vpeak.

Rear Panel

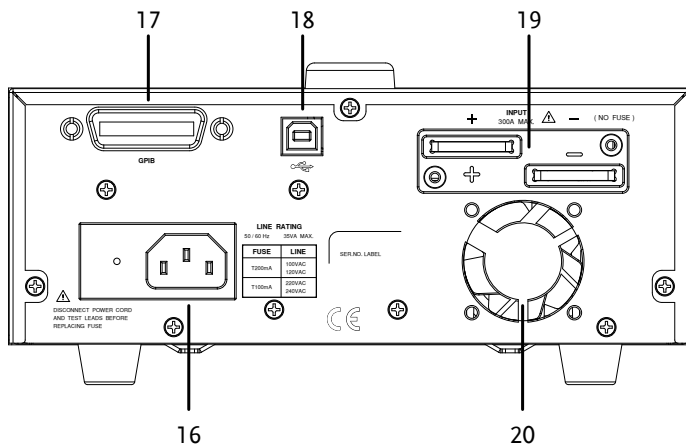

16. Power Cord Socket

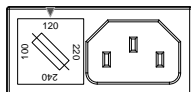

Fuse Socket

Accepts the power cord.
 Input: AC 100/120/220/240V
 ±10%
 Line frequency: 50Hz/60Hz
 Power: 35VA Max
 Fuse rating: T200mA, 250V for
 AC 100/120V; T100mA, 250V for
 AC 220/240V

17. GPIB
 Communicati
 on Port

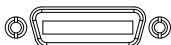

GPIB used for remote control.

18. USB
 Communicati
 on Port



USB B device port. Used for
 remote control and firmware
 update.

19. AC/DC 300A
Terminal

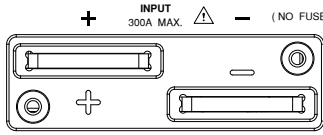

Accepts AC/DC.
300A maximum
current input.

20. Fan

Temperature controlled fan.

OPERATION

Set Up	19
Power Up	19
Rack Mount	20
Wire Gauge Considerations	21
Input Terminals	22
Basic Operation	25
Selecting AC/DC Current	25
Selecting the Current Range.....	25
Selecting AC/DC Voltage.....	26
Selecting the Voltage Range.....	27
Voltage Range Conversion Table	28
Crest Factor Table	29
Using the Current Monitor Output.....	30
How to Use the Function Menu	31
View the Software Version.....	33
Default Settings	34
Setting the USB-UART Baud Rate.....	35
Setting the GPIB Address.....	36
Setting the AD Speed	37
Setting the Averaging Mode.....	38
Setting the Averaging Number for the DCV/ACV/DCA/ACA	39
Setting the Autozero Function	40
Beeper Settings.....	41

Set Up

Power Up

- Steps
1. Connect the power cord to the rear panel socket.

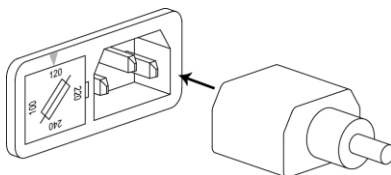

2. Press the power switch.

The unit will perform a calibration data and ROM check and then display the software version momentarily before it is ready to be used.

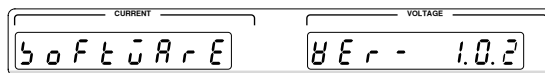

In the event the calibration data and ROM check fails, CAL DATA FAIL will be displayed on the screen, as shown below. If the calibration data and ROM check fails, return the unit to an authorized GW Instek service center.



Note: The CAL DATA FAIL message will remain on the display until it is cleared. Press any key to clear the error message.

Rack Mount

Background

The PCS-1000 has two types of the racks, GRA-419-E and the GRA-419-J for the EIA and JIS standards, respectively. Both types of the racks are 2U height racks and can fit 1 or 2 units. See the GRA-419 assembly manual for details.

GRA-419-E

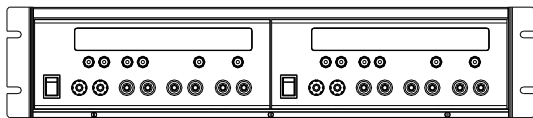
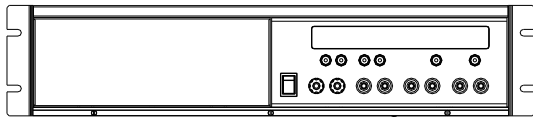

GRA-419-J

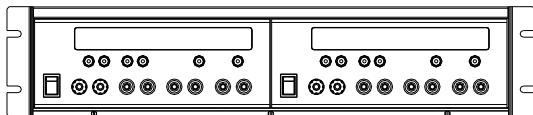
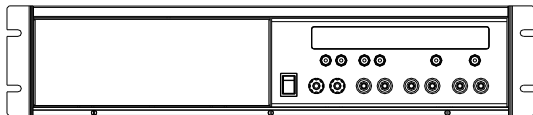

Wire Gauge Considerations

Background

Before connecting the input terminals to a current/voltage source, the wire gauge of the cables should be considered.

It is essential that the current capacity of the cables is adequate. The rating of the cables must equal or exceed the maximum current input for the selected range.

Recommended wire gauge

Wire Gauge (AWG)	Nominal Cross Section (mm ²)	Maximum Current (A)
20	0.5	9
18	1	13
16	1.5	18
14	2.5	24
12	4	34
10	6	45
8	10	64
6	16	88
4	25	120
2	32	145
1	50	190
00	70	240
000	95	290
0000	120	340



WARNING

Withstand voltage wire recommendations

As the PCS-1000 is a CAT II instrument, please ensure that the insulation capacity of the test cables exceed the DUT output voltage when performing current measurement.

Input Terminals

Background

There are 3 terminals for the 300A, 30A and 3A/300mA/30mA ranges, respectively.

The 300A range uses the rear panel terminals and uses M8 crimped terminal cables.

The 30A range uses the 30A terminal and uses M4 sized crimped terminal cables or banana plugs.

The 3A input terminal uses standard banana plugs (GW Instek part number GTL-105A). The 3A terminal supports 3A, 30mA and 300mA ranges.



WARNING

Ensure any current or voltage sources are disabled before connecting any cables to the PCS-1000.

Steps

1. Turn the power switch off.

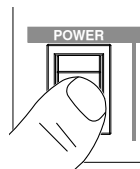

2. Connect the PCS-1000 in series with the load and source. The current monitor output can be used in conjunction with a voltage meter.

Page 20



WARNING:

Do not short the positive or negative 3A, 30A and 300A terminals.

Current Meter
Connection

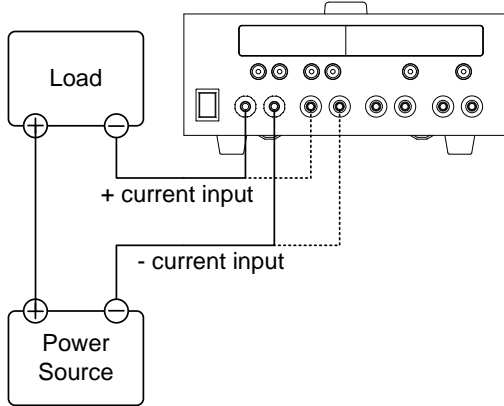

Voltage Meter
Connection

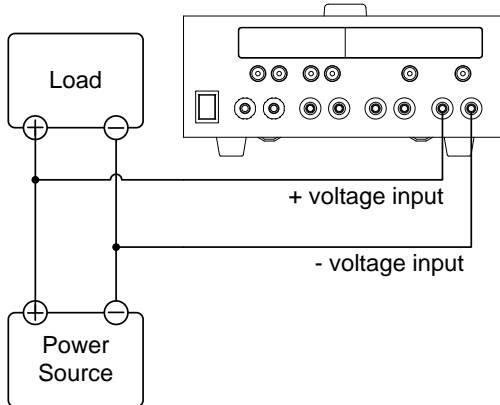

Voltage + Current
Meter Connection

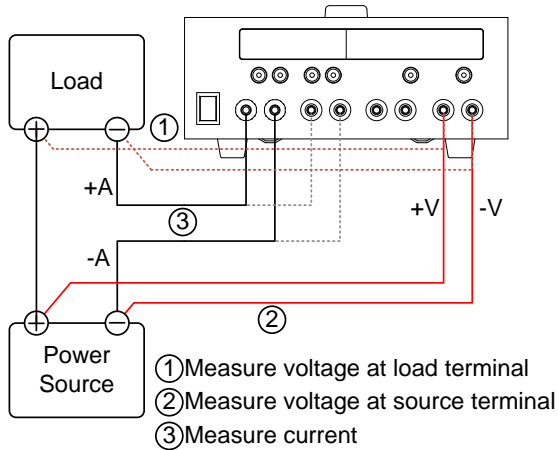

Current Monitor

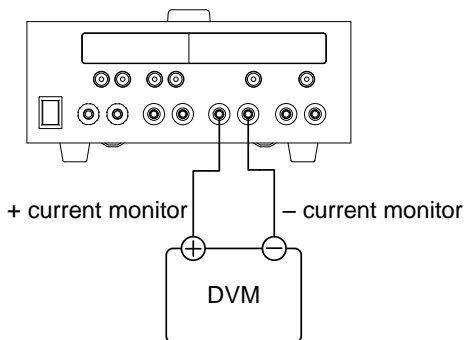

Rear Panel
Terminals

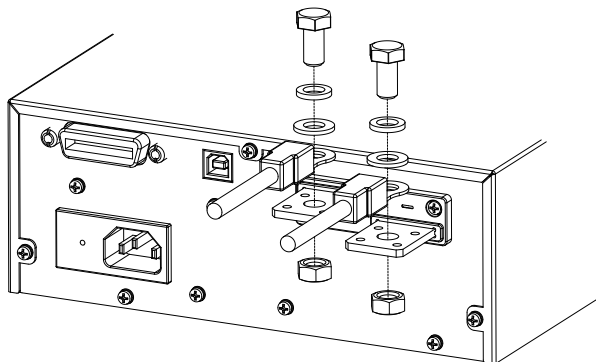

Basic Operation

Selecting AC/DC Current

Background AC or DC current can be measured when in measurement mode.

- Steps**
1. Press the AC/DC key under the CURRENT meter current display to toggle between AC and DC current measurement.
 2. The ACA or DCA indicator will be shown on the display.

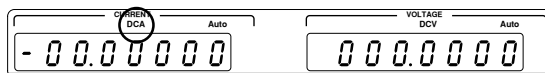

Selecting the Current Range

Background There are 5 selectable current ranges. The range can be manually or automatically selected. Selecting a current range will also select the corresponding the input terminal.

300A/30A Press the *300/30A* key to toggle between the 300A and 30A ranges (as indicated on the display).

The 300A range will select the 300A terminal.
The 30A range will select the 30A terminal.

3A Press the *3A Range* key toggle between the 30mA, 300mA and 3A ranges. Selecting the 3A, 30mA or 300mA range will select the 3A terminal.



Note

The selected range is indicated by the displayed unit (A or mA) and the number of significant digits before the decimal place:

- 3A: Unit=A; 1 significant digit
- 30mA: Unit=mA; 2 significant digits
- 300mA: Unit=mA; 3 significant digits

Autorange

Long push the Auto (3A Range) key to select autorange.

Auto will be displayed in the CURRENT display when autorange is active.

The autorange function is only applicable for the 3A, 30mA and 300mA ranges. Autorange is not supported for the 30A and 300A ranges.



Note

Autorange will also be automatically selected when switching from 300A/30A to 3A.

Selecting AC/DC Voltage

Background

AC or DC voltage can be measured.

Steps

1. Press the AC/DC key under the VOLTAGE meter display to toggle between AC and DC voltage measurement.
2. The ACV or DCV indicator will be shown on the display.



Selecting the Voltage Range

Background There are 5 selectable voltage ranges. The range can be manually or automatically selected.

Manual Ranges Press the *Range* key to cycle between each voltage range.

ACV:	200mV, 2V, 20V, 200V, 600V
DCV:	200mV, 2V, 20V, 200V, 1000V



Note

The selected range is indicated by the displayed unit (V or mV) and the number of significant digits before the decimal place:

200mV: Unit=mV; 3 significant digits

2V: Unit=V; 1 significant digit

20V: Unit=V; 2 significant digits

200V: Unit=V; 3 significant digits

AC 600V: Unit=V; 3 significant digits

DC 1000V: Unit=V; 4 significant digits

Autorange

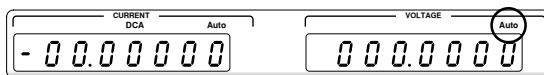

Long push the Auto key to select autorange.

Auto will be displayed in the VOLTAGE display when autorange is active.

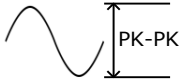
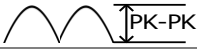
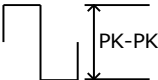

Voltage Range Conversion Table

This table shows the relationship between AC and DC readings in various waveforms.

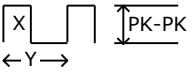
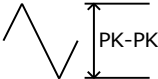





Waveform	Peak to Peak	AC (True RMS)	DC
Sine 	2.828	1.000	0.000
Rectified Sine (full wave) 	1.414	0.435	0.900
Rectified Sine (half wave) 	2.000	0.771	0.636
Square 	2.000	1.000	0.000
Rectified Square 	1.414	0.707	0.707
Rectangular Pulse 	2.000	$2K$ $K = \sqrt{(D - D^2)}$ $D = X/Y$	$2D$ $D = X/Y$
Triangle Sawtooth 	3.464	1.000	0.000

Crest Factor Table

Crest factor is the ratio of the peak signal amplitude to the RMS value of the signal. It determines the accuracy of AC measurement.

If the crest factor is less than 3.0, voltage measurement will not result in error due to dynamic range limitations at full scale.

If the crest factor is more than 3.0, it usually indicates an abnormal waveform as seen from the below table.

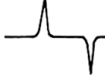
Waveform	Shape	Crest factor
Square wave		1.0
Sine wave		1.414
Triangle sawtooth		1.732
Mixed frequencies		1.414 ~ 2.0
SCR output 100% ~ 10%		1.414 ~ 3.0
White noise		3.0 ~ 4.0
AC Coupled pulse train		>3.0
Spike		>9.0

Using the Current Monitor Output

Background The current monitor is used to measure the voltage drop across the shunt resistors manually.

The current monitor outputs the full scale current input (for the selected range) as a voltage of 0~300mV.

Shunt Values	Range	Shunt
	30 mA	10Ω
	300 mA	1Ω
	3 A	0.1Ω
	30 A	0.01Ω
	300 A	0.001Ω

Steps 1. Set the PCS-1000 for normal operation, as described previously in this chapter, page 25~27.

Make note of the range used and the shunt that is used for that range.

2. Connect the current monitor output to a DVM.
3. Use OHM's law, $V=IR$, to determine the current across the shunt resistor.

For example:

If we are using the 3A current range (and thus the 0.1Ω shunt) and the current monitor outputs 150mV, then:

$$\begin{aligned} \text{Input current} &= \text{monitor output} / \text{shunt } \Omega \\ &= 150\text{mV} / 0.1\Omega \\ &= 1.5\text{A} \end{aligned}$$

How to Use the Function Menu

Background

The function menu allows you to view the software information, set the remote settings, the DCV, ACV, DCA, ACA averaging settings and other settings.

Menu Item	Range/Description
Software Version	Displays the software version on the display.
Factory Default	Load the default settings.
USB to Serial Port Baud Rate	115200, 57600, 38400, 19200, 9600, 4800
GPIB Address	00 ~ 30
AD Speed (measurement resolution)	7_sec (6½ digits), 30_sec (5½ digits), 100_sec (4½ digits)
AVG Mode	SHIFT, TOTAL
DCV AVG	01 ~ 10, 20, 30, 40, 50, 60, 70, 80, 90, 100
ACV AVG	01 ~ 10, 20, 30, 40, 50, 60, 70, 80, 90, 100
DCA AVG	01 ~ 10, 20, 30, 40, 50, 60, 70, 80, 90, 100
ACA AVG	01 ~ 10, 20, 30, 40, 50, 60, 70, 80, 90, 100
Auto Zero	Enable, Disable
Beeper	On, Off
Save Func Set	Saves the settings in the function menus.
Exit Func Set	Exits the function menu.

Steps

1. Press and long push the *Func* key.

The software version will be displayed first.

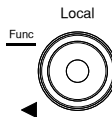

2. Use the ◀ *Func* ▶ keys to scroll through the menu items.

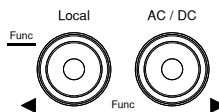

3. Use the ▼ *Select* ▲ keys to choose the parameter for the selected menu item.

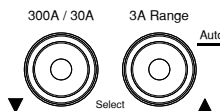

4. Press the *Enter* key to set the parameter and go to the next menu item.

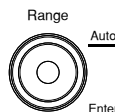

Save Setup

To save the settings use the ◀ *Func* ▶ keys to navigate to *SAVE FUNC SET*.

Press the *Enter* key to save all the settings and exit the function menu.

Exit Without Saving

To exit without saving, navigate to the *EXIT FUNC SET* menu using the ◀ *Func* ▶ keys and press the *Enter* key to exit without saving any settings.

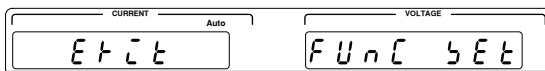

Note

If the settings in the function menu are not saved, then the settings will only apply until the unit is reset.



Note

The display uses a 7 segment LED display. The appendix has an ASCII Table if you have trouble understanding the characters on the LED display character set. See page 88.

View the Software Version

Background The display will show the software version.

Display

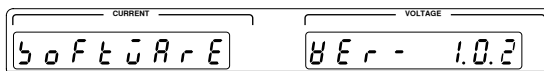

Steps Long push the *Func* key.

The software version is displayed on the screen (it is the first item in the function menu).

Exit To exit, use the ◀ *Func* ▶ keys to change the menu to the *EXIT FUNC SET* menu item. Press the *Enter* key to exit.

Default Settings

Background The Factory Default function will restore the default settings.

- Steps
1. Long push the *Func* key.

The function menu will appear.
 1. Use the ◀ *Func* ▶ keys to navigate to the *FACTORY DEFAULT* menu.
 2. Press the *Enter* key to set the mode.
- See page 88 for a list of the default settings.

Setting the USB-UART Baud Rate

Background The baud rate settings are used for remote control via the USB B port. The USB B connection uses a virtual COM port to simulate a serial port (UART) connection. The baud rate can be set to 115200, 57600, 38400, 19200, 9600, 4800.

See the Communication Interface chapter on page 42 chapter for details on remote control.



Note

The USB driver needs to be installed for the baud rate settings to be applicable. See page 48 for details.

Steps

1. Long push the *Func* key.

The function menu will appear.

2. Use the ◀ *Func* ▶ keys to navigate to the *BAUDRATE* settings.
 3. Use the ▼ *Select* ▲ keys to select a baud rate. Press the *Enter* key to set the baud rate.
 4. Use the ◀ *Func* ▶ keys to change the menu to the *SAVE FUNC SET* menu item. Press the *Enter* key to save.
-



Note

To exit without saving, navigate to the *EXIT FUNC SET* menu using the ◀ *Func* ▶ keys and press the *Enter* key to exit without saving any settings.

Setting the GPIB Address

Background The GPIB port is used for remote control. The GPIB address can be set between 00 ~ 30.

See the Communication Interface chapter on page 42 chapter for details on remote control.

- Steps**
1. Long push the *Func* key.
The function menu will appear.
 2. Use the ◀ *Func* ▶ keys to navigate to the *ADDRESS* settings.
 3. Use the ▼ *Select* ▲ keys to select the GPIB address. Press the *Enter* key to set the address.
 4. Use the ◀ *Func* ▶ keys to navigate to the *SAVE FUNC SET* menu item. Press the *Enter* key to save.
-



Note

To exit without saving, navigate to the *EXIT FUNC SET* menu using the ◀ *Func* ▶ keys and press the *Enter* key to exit without saving any settings.

Setting the AD Speed

Background The ADC IC speed has a number of settings. The higher the setting, the lower the accuracy and resolution of the meter.

Range: Seconds (resolution):
7 (6½ digits), 30 (5½ digits),
100 (4½ digits)

- Steps**
1. Long push the *Func* key.

The function menu will appear.
 2. Use the ◀ *Func* ▶ keys to navigate to the *AD SPEED* menu.
 3. Use the ▼ *Select* ▲ keys to select the AD speed. Press the *Enter* key to set the speed.

By default the AD Speed is set to 7 (6½ digits).
 4. Use the ◀ *Func* ▶ keys to navigate to the *SAVE FUNC SET* menu item. Press the *Enter* key to save.
-



Note

To exit without saving, navigate to the *EXIT FUNC SET* menu using the ◀ *Func* ▶ keys and press the *Enter* key to exit without saving any settings.

Setting the Averaging Mode

Background There are two different types of averaging modes, SHIFT or TOTAL.

SHIFT is a box car averaging mode while TOTAL will average all the collected samples to get the average value.

Range SHIFT, TOTAL

- Steps**
1. Long push the *Func* key.
The function menu will appear.
 2. Use the ◀ *Func* ▶ keys to navigate to the *AVG MODE* menu.
 3. Use the ▼ *Select* ▲ keys to select the Averaging Mode. Press the *Enter* key to set the mode.

By default the average mode is set to SHIFT.
 4. Use the ◀ *Func* ▶ keys to navigate to the *SAVE FUNC SET* menu item. Press the *Enter* key to save.
-



Note

To exit without saving, navigate to the *EXIT FUNC SET* menu using the ◀ *Func* ▶ keys and press the *Enter* key to exit without saving any settings.

Setting the Averaging Number for the DCV/ACV/DCA/ACA

Background Each of the different measurement modes (DCV, ACV, DCA, ACA) can have the number of averages set individually.

Range 01 ~ 10, 20, 30, 40, 50, 60, 70, 80, 90, 100

- Steps
1. Long push the *Func* key.

The function menu will appear.
 2. Use the ◀ *Func* ▶ keys to navigate to the *DCV AVG*, *ACV AVG*, *DCA AVG* or *ACA AVG* menu.
 3. Use the ▼ *Select* ▲ keys to select the number of averages for the selected mode. Press the *Enter* key to set the mode.

By default the number of averages is 10.

4. Use the ◀ *Func* ▶ keys to navigate to the *SAVE FUNC SET* menu item. Press the *Enter* key to save.
-



Note

To exit without saving, navigate to the *EXIT FUNC SET* menu using the ◀ *Func* ▶ keys and press the *Enter* key to exit without saving any settings.

Setting the Autozero Function

Background	The Autozero function will automatically perform a zero calibration when the unit is turned on.	
	Range	Enable, Disable

- Steps
1. Long push the *Func* key.
The function menu will appear.
 2. Use the ◀ *Func* ▶ keys to navigate to the *AUTOZERO* menu.
 3. Use the ▼ *Select* ▲ keys to enable autozero. Press the *Enter* key to set the mode.

By default the Autozero is already enabled.
 4. Use the ◀ *Func* ▶ keys to navigate to the *SAVE FUNC SET* menu item. Press the *Enter* key to save.



Note

To exit without saving, navigate to the *EXIT FUNC SET* menu using the ◀ *Func* ▶ keys and press the *Enter* key to exit without saving any settings.

Beeper Settings

Background	The beeper sound that is used for key presses and other system sounds can be turned on or off using this menu.
------------	--

Range	On, Off
-------	---------

- Steps
1. Long push the *Func* key.
The function menu will appear.
 2. Use the ◀ *Func* ▶ keys to navigate to the *BEEPER* menu.
 3. Use the ▼ *Select* ▲ keys to the beeper on or off. Press the *Enter* key to set the mode.
By default the beeper sound is turned on.
 4. Use the ◀ *Func* ▶ keys to navigate to the *SAVE FUNC SET* menu item. Press the *Enter* key to save.
-



Note

To exit without saving, navigate to the *EXIT FUNC SET* menu using the ◀ *Func* ▶ keys and press the *Enter* key to exit without saving any settings.

C COMMUNICATION INTERFACE

This chapter describes basic configuration of IEEE488.2 based remote control.

Interface Configuration	44
Configure GPIB Interface	44
GPIB Function Check	45
USB Driver Installation.....	48
USB Interface Settings	50
USB Function Check.....	53
Return to Local Operation.....	55
 Command Syntax	 56
 Command List.....	 59
Configure Commands	61
CONFigure.....	61
CONFigure:CURRent	62
CONFigure:CURRent[:DC]	62
CONFigure:CURRent:AC.....	63
CONFigure:VOLTage	63
CONFigure:VOLTage[:DC]	64
CONFigure:VOLTage:AC.....	65
CONFigure:AVERage:MODE	65
Measure Commands	66
MEASure.....	66
MEASure:CURRent[:DC].....	66
MEASure:CURRent:AC	67
MEASure:VOLTage[:DC].....	67
MEASure:VOLTage:AC	67
READ.....	67

Sense Commands.....	69
[SENSe:]CURRent:RANGe.....	69
[SENSe:]CURRent:DC:AVERAge:COUNT.....	70
[SENSe:]CURRent:AC:AVERAge:COUNT.....	70
[SENSe:]VOLTage:RANGe.....	70
[SENSe:]VOLTage:DC:AVERAge:COUNT.....	71
[SENSe:]VOLTage:AC:AVERAge:COUNT.....	72
System Commands	73
SYSTem:BEEPer:STATe	73
SYSTem:ERRor.....	74
SYSTem:LOCal.....	74
SYSTem:REMOte.....	75
SYSTem:RWLock	75
SYSTem:VERSion.....	75
SYSTem:OUTPut:FORMat	75
Status Commands	77
STATus:OPERation:CONDition	77
STATus:OPERation:ENABle	78
STATus:OPERation[:EVENT].....	78
STATus:PRESet	79
STATus:QUEStionable:CONDition.....	79
STATus:QUEStionable:ENABle.....	80
STATus:QUEStionable[:EVENT].....	80
Common Commands	81
*IDN?	81
*ESE	81
*ESR?	82
*SRE	82
*STB?	83
*PSC.....	84
*OPC.....	84
*TST?	85
*CLS.....	85
*RST	85
*WAI.....	85
Status Registers	86
Error Messages	87

Interface Configuration

Configure GPIB Interface

To use GPIB the GPIB address must first be set.

- Configure GPIB
1. Connect the GPIB cable from the GPIB controller to the PCS-1000.
 2. Turn the PCS-1000 on.
 3. Long push *Func* key to enter the function menu. Page 31
 4. Use the ◀ *Func* ▶ keys to go to the *ADDRESS* function.
 5. Select the address using the ▼ *Select* ▲ keys.
GPIB Address 00~30
 6. Press the *Enter* key to confirm the selection.



Note

RMT will be displayed on the screen when the unit is remote mode.

- GPIB constraints
- Maximum 14 devices altogether, 20m cable length, 2m between each device
 - Unique address assigned to each device
 - At least 2/3 of the devices turned On
 - No loop or parallel connection

GPIB Function Check

Background To test the GPIB functionality, National Instruments Measurement and Automation Explorer can be used. This program is available on the NI website, www.ni.com, via a search for the VISA Run-time Engine page, or “downloads” at the following URL, <http://www.ni.com/visa/>

Requirements Operating System: Windows XP, 7, 8

Functionality check 1. Start the NI Measurement and Automation Explorer (MAX) program. Using Windows, press:

Start>All Programs>National Instruments>Measurement & Automation



1. From the Configuration panel access;

My System>Devices and Interfaces>GPIBX (where X is the GPIB card number that is connected to the PCS-1000).

2. Click *Scan for Instruments*.

3. Double click on the *Instrument 0* icon.

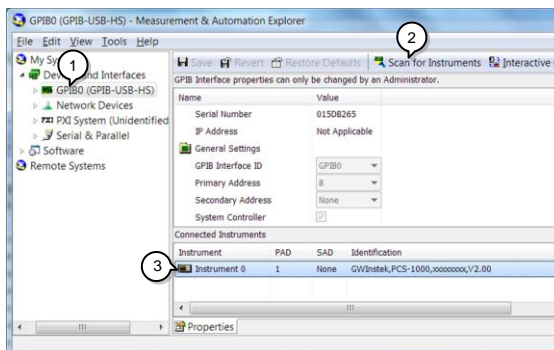

4. Click on *Communicate with Instrument*.
5. In the communicator window that appears, ensure **IDN?* is written in the *Send* test box.
6. Click on the *Query* button to send the **IDN?* query to the instrument.
7. The following string should be returned:

GWInstek, PCS-1000, xxxxxxxxx, Vx.xx

(Manufacturer, model, serial, software version)

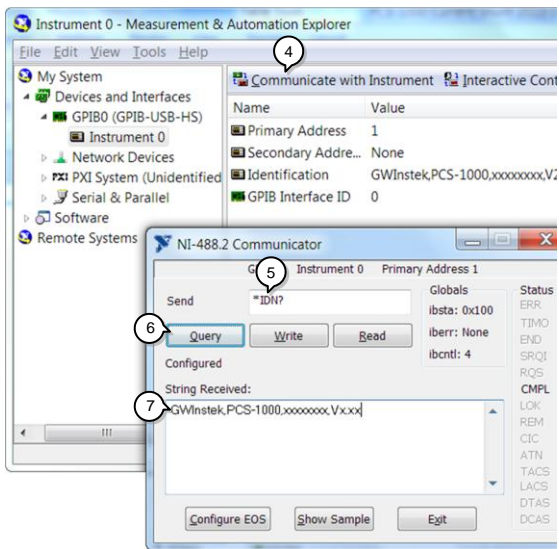

209.1711 mm.

USB Driver Installation

Background The USB driver is actually a virtual COM port driver that simulates a serial port (UART) connection.

Note: The USB driver should not need to be manually installed if your operating system has been fully updated. In most cases, the PCS-1000 driver should be automatically installed when connected to the PC.

If the driver is not automatically detected, or if your operating system is not fully updated, it may be necessary to install the USB driver, as shown below.

Requirements Operating System: Windows XP, Vista, 7, 8, 8.1



Note

The following installation instructions only apply if the USB driver does not get automatically installed.

- Steps**
1. Connect the PCS-1000 to a PC using the USB Type A-Type B cable (GTL-240).
 2. The Windows *Found New Hardware* wizard should pop up asking you to install the device driver.
 3. Select *Locate and install driver software*.
 4. You will now be asked to insert a disk that contains the USB driver.

Insert the User Manual CD. Windows will automatically install the USB driver.

Note: If the Windows Security pop-up appears,

choose *Install this driver software anyway*.

5. The PCS-1000 will now become available in the device tree under *PORTS (COM & LPT)* in the Windows Device Manager.

Alternate Installation

If the Found New Hardware wizard does not appear or you wish to install the driver from another location, the driver can be also installed from the Windows Device Manager.

1. Open the Windows Device Manager. Using Windows 7, press:

Start>Control Panel>Hardware and Sound>Device Manager

2. From the device tree go to: *Other devices>USB Serial Port*

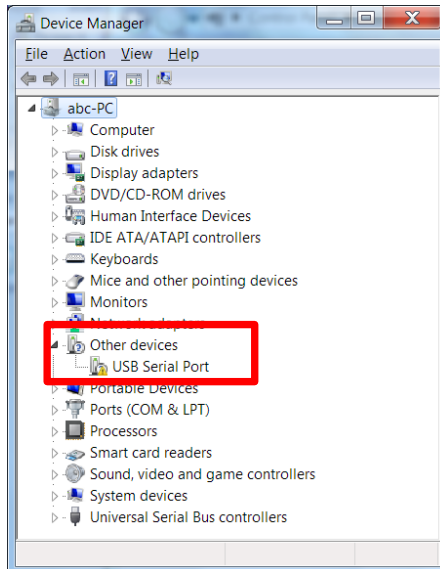

The yellow error sign indicates that a driver has not been installed.

3. Right-click USB Serial Port and select *Update Driver Software*.

Select *Browse my computer for driver software* when prompted.

Select the directory with the USB drivers from the User Manual CD when prompted.

Note: If the Windows Security pop-up appears, choose *Install this driver software anyway*.

4. The PCS-1000 will now become available in the device tree under *PORTS (COM & LPT)*.



Note

If required, the USB drivers can be downloaded from <http://www.ftdichip.com/Drivers/VCP.htm>.

If the drivers are downloaded, they can be installed using the Alternate Installation method described on the previous page.

USB Interface Settings

Baud Rate Settings

1. Connect the USB cable from the PC to the rear panel USB-B port on the PCS-1000.
2. Turn the PCS-1000 on.
3. Long push *Func* key to enter the function menu. Page 31
4. Use the ◀ *Func* ▶ keys to go to the *BAUDRATE* function.
5. Select the baud rate using the ▼ *Select* ▲ keys.

Baud Rate	4800, 9600(default), 19200, 38400, 57600, 115200
-----------	---

6. Press the *Enter* key to confirm the selection.
 7. Use the ◀ *Func* ▶ keys to go to the *SAVE FUNC SET* function.
 8. Press the *Enter* key to save the baud rate settings.
-

Edit UART Settings

1. Connect the PCS-1000 to the PC using the GTL-240 USB cable.
2. Open the Windows Device Manager, using Windows 7, click:

Start>Control Panel>Hardware and Sound>Device Manager:
3. In the device tree go to: PORTS (COM & LPT)>PCS-1000 (COM XX)
4. Right-click PCS-1000 and select Properties.
5. Go to the Port Settings tab and from there you can set any other UART settings such as data bits, parity, number of stop bits and the flow control.

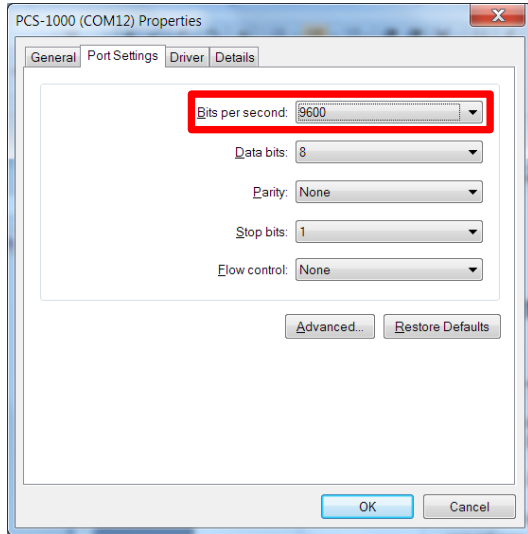

USB Function Check

Background To test the USB functionality, National Instruments Measurement and Automation Explorer can be used. This program is available on the NI website, www.ni.com, via a search for the VISA Run-time Engine page, or “downloads” at the following URL, <http://www.ni.com/visa/>

Requirements Operating System: Windows XP, 7, 8, 8.1

- Functionality check**
1. Open the Windows Device Manager to see which COM port the PCS has been assigned. Using Windows 7, press:

Start>Control Panel>Hardware and Sound>Device Manager

The COM port number will be shown in the device tree under: *PORTS (COM & LPT)>PCS-1000 (COM XX)*
 2. Start the NI Measurement and Automation Explorer (MAX) program. Using Windows, press:

Start>All Programs>National Instruments>Measurement & Automation



3. From the Configuration panel access;

My System>Devices and Interfaces>Serial & Parallel>COMX (where X is the COM port number assigned to the PCS-1000).

4. Click on the *Port Settings* tab at the bottom.

5. Make sure the *Baud rate* settings are correct (PCS-1000 default = 9600 baud).

6. Click on *Open Visa Test Panel*.

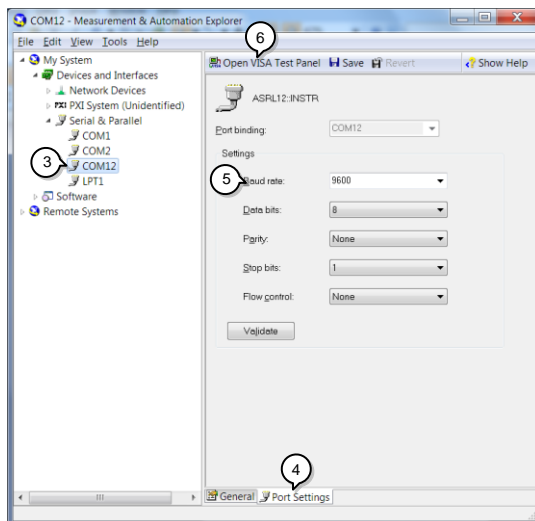

7. Click on *Input/Output*.
8. In the *Select or Enter Command* drop down list, ensure **IDN?* is selected.
9. Click on the *Query* button to send the **IDN?* query to the instrument.
10. The following string should be returned:

GWInstek, PCS-1000, xxxxxxxxx, Vx.xx

(Manufacturer, model, serial, software version)

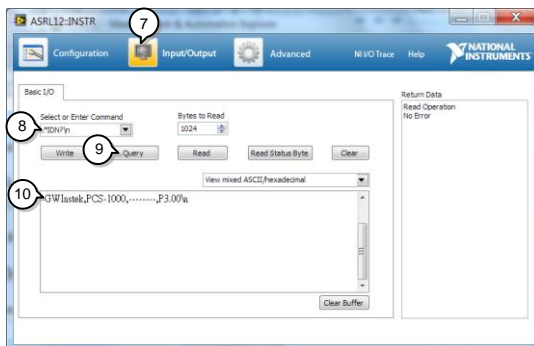

Return to Local Operation

Steps

1. Press the *Local* key to return to local operation.
2. The RMT icon will turn off when you have returned to local mode.

Command Syntax

Compatible Standard	IEEE488.2	Partial compatibility
	SCPI, 1999	Partial compatibility

Command Structure

SCPI commands follow a tree-like structure, organized into nodes. Each level of the command tree is a node. Each keyword in a SCPI command represents each node in the command tree. Each keyword (node) of a SCPI command is separated by a colon (:).

For example, the diagram below shows an SCPI sub-structure and a command example.

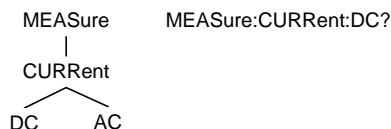

Command types

There are a number of different instrument commands and queries. A command sends instructions or data to the unit and a query receives data or status information from the unit.

Command types

Simple A single command with/without a parameter

Example *IDN?

Query A query is a simple or compound command followed by a question mark (?). A parameter (data) is returned.

Example meas:curr:dc?

Compound Two or more commands on the same command line. Compound commands are separated with either a semi-colon (;) or a semi-colon and a colon (;:).

A semi-colon is used to join two related commands, with the caveat that the last command must begin at the last node of the first command.

A semi-colon and colon are used to combine two commands from different nodes.

Example conf:curr?::meas:volt:dc?

Command Forms Commands and queries have two different forms, long and short. The command syntax is written with the short form of the command in capitals and the remainder (long form) in lower case.

The commands can be written in capitals or lower-case, just so long as the short or long forms are complete. An incomplete command will not be recognized.

Below are examples of correctly written commands.

Long form	CONFigure:VOLTage? CONFIGURE:VOLTAGE? configure:voltage?
Short form	CONF:VOLT? conf:volt?

Square Brackets Commands that contain square brackets indicate that the contents are optional. The function of the command is the same with or without the square bracketed items, as shown below.

For “MEASure:CURRent[:DC]?”, both “MEASure:CURRent:DC?” and “MEASure:CURRent?” are both valid forms.

Command Format	<p>CURR:RANG AUTO</p> <p>1 2 3</p>	<ol style="list-style-type: none"> 1. Command header 2. Space 3. Parameter 1
-----------------------	--	---

Parameters	Type	Description	Example
	<Boolean>	Boolean logic	0, 1
	<NR1>	integers	0, 1, 2, 3

<NR2>	decimal numbers	0.1, 3.14, 8.5
<NR3>	floating point	4.5e-1, 8.25e+1
<NRf>	any of NR1, 2, 3	1, 1.5, 4.5e-1
<block data>	Definitive length arbitrary block data. A single decimal digit followed by data. The decimal digit specifies how many 8-bit data bytes follow.	

Message Terminator	LF	Line feed code
--------------------	----	----------------

Command List

Configure	CONFigure.....	61
Commands	CONFigure:CURRent.....	62
	CONFigure:CURRent[:DC]	62
	CONFigure:CURRent:AC.....	63
	CONFigure:VOLTage.....	63
	CONFigure:VOLTage[:DC]	64
	CONFigure:VOLTage:AC.....	65
	CONFigure:AVERage:MODE	65
	MEASure	66
Measure Commands	MEASure:CURRent[:DC].....	66
	MEASure:CURRent:AC	67
	MEASure:VOLTage[:DC].....	67
	MEASure:VOLTage:AC	67
	READ	67
	[SENSe:]CURRent:RANGe	69
Sense Commands	[SENSe:]CURRent:DC:AVERage:COUNT.....	70
	[SENSe:]CURRent:AC:AVERage:COUNT	70
	[SENSe:]VOLTage:RANGe.....	70
	[SENSe:]VOLTage:DC:AVERage:COUNT.....	71
	[SENSe:]VOLTage:AC:AVERage:COUNT	72

System	SYSTem:BEEPer:STATe	73
Commands	SYSTem:ERRor	74
	SYSTem:LOCal	74
	SYSTem:REMOte.....	75
	SYSTem:RWLock	75
	SYSTem:VERSion.....	75
	SYSTem:OUTPut:FORMat	75
Status	STATus:OPERation:CONDition	77
Commands	STATus:OPERation:ENABle	78
	STATus:OPERation[:EVENT].....	78
	STATus:PRESet	79
	STATus:QUEStionable:CONDition.....	79
	STATus:QUEStionable:ENABle.....	80
	STATus:QUEStionable[:EVENT].....	80
Common	*IDN?	81
Commands	*ESE	81
	*ESR?	82
	*SRE.....	82
	*STB?	83
	*PSC.....	84
	*OPC.....	84
	*TST?	85
	*CLS	85
	*RST	85
	*WAI.....	85

Configure Commands

CONFigure.....	61
CONFigure:CURRent.....	62
CONFigure:CURRent[:DC]	62
CONFigure:CURRent:AC.....	63
CONFigure:VOLTage.....	63
CONFigure:VOLTage[:DC]	64
CONFigure:VOLTage:AC.....	65
CONFigure:AVERage:MODE	65

CONFigure

→ **Query**

Description	The CONFigure query will return both the current and voltage configuration as a string.
Query Syntax	CONFigure?
Return Parameter	<string> Current mode, range unit, voltage mode, range unit.
Query Example	CONF? >"CURR:DC 0.01,VOLT:DC 0.1"



Note

The range that is returned is the base unit. See the table below:

Unit	Voltage Range	Current Range
1000	1000VDC	N/A
600	600ACV	N/A
100	200V	300A
10	20V	30A
1	2V	3A
0.1	200mV	300mA
0.01	N/A	30mA

CONFigure:CURRent

→ **Query**

Description	The CONFigure:CURRent query will return the current range unit.
Query Syntax	CONFigure:CURRent?
Return Parameter	<string> Returns the current mode and range unit.
Query Example	CONF:CURR? > "DC 0.01"



Note

The range that is returned is the base unit. See the table below:

Unit	Current Range
100	300A
10	30A
1	3A
0.1	300mA
0.01	30mA

CONFigure:CURRent[:DC]

Set →

Description	This command will set the current mode to DC and set the range. If the range is not specified, then it will not change.
Syntax	CONFigure:CURRent[:DC] [<Range> AUTO]
Parameter	<p><Range> Current range <NRf>: 0.00000001~305 The unit will automatically be set to the closest range.</p> <p>AUTO Autorange; Only applicable for the ≤3A ranges. Autorange is not supported for the 30A and 300A ranges.</p>

Example	CONF:CURR 20 Sets the current mode to DC and the range to 30A
Example	CONF:CURR Sets the current mode to DC. The range is not changed.

CONFigure:CURRent:AC (Set) →

Description	This command will set current mode to AC and set the range. If the range is not specified, then it will not change.	
Syntax	CONFigure:CURRent:AC [<Range> AUTO]	
Parameter	<Range>	Current range <NRf>: 0.00000001~305 Current range. The unit will automatically be set to the closest range.
	AUTO	Autorange; Only applicable for the ≤3A ranges. Autorange is not supported for the 30A and 300A ranges.
Example	CONF:CURR:AC 100	Sets the current mode to AC and the range to 300A.
Example	CONF:CURR:AC	Sets the current mode to AC. The range is not changed.

CONFigure:VOLTage → (Query)

Description	The CONFigure:VOLTage query will return the voltage mode and the voltage range unit.	
Query Syntax	CONFigure:VOLTage?	
Return Parameter	<string>	Returns the voltage mode and range unit.

Query Example `CONF:VOLT?`
 `>"DC 0.1"`

The mode is DCV and the range is 200mV.



Note

The range that is returned is the base voltage unit. See the table below:

Unit	Voltage Range
1000	1000VDC
600	600ACV
100	200V
10	20V
1	2V
0.1	200mV

CONFigure:VOLTage[:DC]



Description This command will set the voltage mode to DC and set the DCV range. If the range is not specified then it will not be changed.

Syntax `CONFigure:VOLTage[:DC] [<Range> | AUTO]`

Parameter `<Range>` Voltage range `<NRf>`: 0.0000001 ~ 1050
 The unit will automatically be set to the closest range.

`AUTO` Autoset

Example `CONF:VOLT:DC 20`
 Sets the voltage mode to DC and the DCV range to 20V.

Example `CONF:VOLT:DC`
 Sets the voltage mode to DC. The range stays the same.

CONFigure:VOLTage:AC

Set →

Description This command will set the voltage mode to AC and set the ACV range. If the range is not specified then it will not be changed.

Syntax CONFigure:VOLTage:AC [<Range> | AUTO]

Parameter

<Range>	Voltage range <NRf>: 0.0000001~630 The unit will automatically be set to the closest range.
AUTO	Autoset

Example CONF:VOLT:AC 20
Sets the voltage mode to AC and the ACV range to 20V.

Example CONF:VOLT:AC
Sets the voltage mode to AC. The range stays the same.

Set →

CONFigure:AVERage:MODE

→ Query

Description This command will set or query the average mode.

Syntax CONFigure:AVERage:MODE {0|1,TOTAL|SHIFT}

Query Syntax CONFigure:AVERage:MODE?

Parameter

0, TOTAL	Total mode
1, SHIFT	Shift mode

Return Parameter

Total	Total mode
Shift	Shift mode

Example CONF:AVER:MODE 0
Sets the average mode to Total mode.

Measure Commands

MEASure	66
MEASure:CURRent[:DC].....	66
MEASure:CURRent:AC	67
MEASure:VOLTage[:DC].....	67
MEASure:VOLTage:AC	67
READ	67

MEASure

→ Query

Description	This query will return all the measurements.	
Query Syntax	MEASure?	
Return Parameter	<NRf>	Returns the current measurement voltage measurement: <current>,<voltage>
Query Example	MEAS? > 9.9768E-1, 3.21E-1 Returns the current measurement (0.99A) and voltage (0.321V) measurement.	

MEASure:CURRent[:DC]

→ Query

Description	This query will return the DC current.	
Query Syntax	Measure:CURRent[:DC]?	
Return Parameter	<NRf>	Return the DC current.
Query Example	MEAS:CURR:DC? >+9.9067E-1 Returns DC current measurement (0.99A).	

MEASure:CURRent:AC → Query

Description	This query will return the AC current.
Query Syntax	MEASure:CURRent:AC?
Return Parameter	<NRf> Returns the AC current.
Query Example	MEAS:CURR:AC? >+9.9067E-1 Returns the AC current measurement (0.9A).

MEASure:VOLTage[:DC] → Query

Description	This query will return the DC voltage.
Query Syntax	MEASure:VOLTage[:DC]?
Return Parameter	<NRf> Returns the DC voltage
Query Example	MEAS:VOLT:DC? >+1.5E+1 Returns the DC voltage measurement (15.0 V).

MEASure:VOLTage:AC → Query

Description	This query will return the AC voltage.
Query Syntax	MEASure:VOLTage:AC?
Return Parameter	<NRf> Returns the AC voltage.
Query Example	MEAS:VOLT:AC? >+2.5E+1 Returns the AC voltage measurement (25V).

READ → Query

Description	The read command will return current and voltage reading.
-------------	---

Query Syntax	READ?
Return Parameter	<NRf> Returns the current and voltage readings, respectively <current>,<voltage>
Query Example	READ? > +9.9067E-1,+2.5E+1 Returns the current and voltage readings.

Sense Commands

[SENSe:]CURRent:RANGe.....	69
[SENSe:]CURRent:DC:AVERAge:COUNT.....	70
[SENSe:]CURRent:AC:AVERAge:COUNT.....	70
[SENSe:]VOLTage:RANGe.....	70
[SENSe:]VOLTage:DC:AVERAge:COUNT.....	71
[SENSe:]VOLTage:AC:AVERAge:COUNT.....	72

[SENSe:]CURRent:RANGe

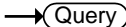

Description	Sets or queries the current range.
Syntax	[SENSe:]CURRent:RANGe {<Range> AUTO}
Query Syntax	[SENSe:]CURRent:RANGe?
Parameter / Return Parameter	<p><Range> Current range <NRf>: 0.00000001~305 Sets the current range in amps. The unit will automatically choose the closest range that is programmed.</p> <p>AUTO Sets the range to AUTO; Only applicable for the ≤3A ranges. Autorange is not supported for the 30A and 300A ranges.</p>
Example	<p>CURR:RANG AUTO Sets the current range to AUTO.</p>

 **Note** The range that is returned is the base unit. See the table below:

Unit	Current Range
100	300A
10	30A
1	3A
.1	300mA
.01	30mA

[SENSe:]CURRent:DC:AVERAge:COUNT (Set) →
→ (Query)

Description	This query will set or return average count setting for DC current.	
Syntax	[SENSe:]CURRent:DC:AVERAge:COUNT (NR1)	
Query Syntax	[SENSe:]CURRent:DC:AVERAge:COUNT?	
Parameter / Return Parameter	<NR1>	The average count setting for DC current. 1~10, 20, 30, 40, 50, 60, 70, 80, 90, 100
Query Example	CURR:DC:AVER:COUN? >10 The average count setting for DC current is 10.	

[SENSe:]CURRent:AC:AVERAge:COUNT (Set) →
→ (Query)

Description	This query will set or return average count setting for AC current.	
Syntax	[SENSe:]CURRent:AC:AVERAge:COUNT (NR1)	
Query Syntax	[SENSe:]CURRent:AC:AVERAge:COUNT?	
Return Parameter	<NR1>	The average count setting for AC current. 1~10, 20, 30, 40, 50, 60, 70, 80, 90, 100
Query Example	CURR:AC:AVER:COUN? >10 The average count setting for AC current is 10.	

[SENSe:]VOLTage:RANGe (Set) →
→ (Query)

Description	Sets or queries the voltage range.	
Syntax	[SENSe:]VOLTage:RANGe {<Range> AUTO}	
Query Syntax	[SENSe:]VOLTage:RANGe?	

Parameter / Return Parameter	<Range> AUTO	Sets the voltage range in volts. The unit will automatically choose the closest range that is programmed. DC Range <NRf>: 0.0000001 ~ 1050 AC Range <NRf>: 0.0000001 ~ 600 Sets the range to AUTO.
---------------------------------	-----------------	---

Example VOLT:RANG AUTO
Sets the voltage range to auto.

 Note The range that is returned is the base voltage unit. See the table below:

Unit	Voltage Range
1000	1000VDC
600	600ACV
100	200V
10	20V
1	2V
0.1	200mV

[SENSe:]VOLTage:DC:AVERage:COUNT  → → 

Description This command will set or return the average count setting for DC voltage.

Syntax [SENSe:]VOLTage:DC:AVERage:COUNT <NR1>

Query Syntax [SENSe:]VOLTage:DC:AVERage:COUNT?

Parameter / Return Parameter	<NR1>	The average count setting for DC voltage. 1~10, 20, 30, 40, 50, 60, 70, 80, 90, 100
---------------------------------	-------	--

Query Example VOLT:DC:AVER:COUN?
>10
The average count setting for DC voltage is 10.

[SENSe:]VOLTage:AC:AVERage:COUNT





Description	This query will set or return the average count setting for AC current.	
Syntax	[SENSe:]VOLTage:AC:AVERage:COUNT <NR1>	
Query Syntax	[SENSe:]VOLTage:AC:AVERage:COUNT?	
Return Parameter	<NR1>	The average count setting for AC voltage. 1~10, 20, 30, 40, 50, 60, 70, 80, 90, 100
Query Example	VOLT:AC:AVER:COUNT? >10 The average count setting for AC voltage is 10.	

System Commands

SYSTem:BEEPer:STATe	73
SYSTem:ERRor.....	74
SYSTem:LOCal.....	74
SYSTem:REMOte.....	75
SYSTem:RWLock	75
SYSTem:VERSion.....	75
SYSTem:OUTPut:FORMat	75

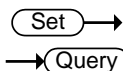
SYSTem:BEEPer:STATe



Description	Sets or queries the beeper status.	
Syntax	SYSTem:BEEPer:STATe {0 1}	
Query Syntax	SYSTem:BEEPer:STATe?	
Parameter/	1	Beeper on
Return Parameter	0	Beeper off
Query Example	SYST:BEEP:STAT? >1 The beeper is on.	

SYSTem:ERRor



Description Queries the error queue. Error messages are stored in FIFO order. Up to 20 error messages are stored in the error queue. The first error message that is stored is the first message that is returned. Each time a message is returned it is also cleared from the queue. When the error queue is queried and there are no error messages, 0, "No error" will be returned. If the error queue is full (20 messages) and an error occurs, the last-stored error message will be overwritten with the -350, "Error queue overflow" message. This message will remain, and no additional messages will be stored until it is cleared.

See page 87 for a list of the error messages.

Query Syntax SYSTem:ERRor?

Return Parameter <string> Returns the next error message in the error queue.

Query Example SYST:ERR?
> 0, "No error."
Returns no error in the error queue.

SYSTem:LOCal



Description Returns the unit back to local mode. This command will enable all panel keys that may have been locked.

Syntax SYSTem:LOCal

SYSTem:REMOte (Set) →

Description Sets the PCS-1000 operation to remote mode. All panel keys except the *Local* key are locked.

Syntax SYSTem:REMOte

SYSTem:RWLock (Set) →

Description Sets the PCS-1000 operation to remote mode. All panel keys are locked, including the *Local* key.

Syntax SYSTem:RWLock

SYSTem:VERSIon → (Query)

Description Queries the SCPI version number.

Query Syntax SYSTem:VERSIon?

Return Parameter <string> Returns the SCPI version as a string.

Query Example SYST:VERS?
 >1999.0
 Returns the SCPI version number as 1999.0.

SYSTem:OUTPut:FORMat (Set) →
→ (Query)

Description Sets or queries the output formatting. There are 4 types of output formatting: 0, 1, 2, 3.

Format "0" is the default format.

The following table will show how each format will differ from each other when the MEASure? query is used.

Format	Description	Example
0	Returns the output in NR3 format.	+0.0E+0,-4.0E-7

- | | |
|---|---|
| 1 | Returns the output in +0.0E+0 ADC,-5.0E-NR3 format + unit. 7 VDC |
| 2 | Returns the output in +0.00000000,-NR2 format. 0.0000004 |
| 3 | Returns the output in +0.00000000 ADC,-NR2 format + unit. 0.0000004 VDC |

Syntax SYSTem:OUTPut:FORMat (0~3)

Query Syntax SYSTem:OUTPut:FORMat?

Parameter / <NR1> 0~3

Return Parameter

Example SYST:OUTP:FORM?
 >3
 Returns the format as NR2 + unit.

Status Commands

STATus:OPERation:CONDition	77
STATus:OPERation:ENABLE	78
STATus:OPERation[:EVENT]	78
STATus:PRESet	79
STATus:QUEStionable:CONDition	79
STATus:QUEStionable:ENABLE	80
STATus:QUEStionable[:EVENT]	80

STATus:OPERation:CONDition

→ Query

Description	Returns the contents of the Standard Operation Condition Register.		
	Bit	Bit weight	Description
	0	1	Calibrating
	1~3	~	Not used
	4	16	Measuring
	5~7	~	Not used
	8	256	Config Change
	9~15	~	Not used
Query Syntax	STATus:OPERation:CONDition?		
Return Parameter	<NR1>	0~65535: Returns the bit weight of the Standard Operation Condition Register.	
Query Example	STAT:OPER:COND? > 256 Indicates that the configuration has been changed.		

STATus:OPERation:ENABLE

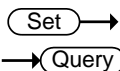

Description	Returns or sets the contents of the Standard Operation Enable Register.	
	Bit	Bit weight
	0	1
	1~3	~
	4	16
	5~7	~
	8	256
	9~15	~
Syntax	STATus:OPERation:ENABLE (0~65535)	
Query Syntax	STATus:OPERation:ENABLE?	
Parameter / Return Parameter	<NR1>	0~65535: Indicates the bit weight of the Standard Operation Enable Register.
Query Example	STAT:OPER:ENAB 273 Enables bit 0, 4 and 8 of the Standard Operation Enable Register.	

STATus:OPERation[:EVENT]

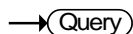

Description	Returns the contents of the Standard Operation Event Register.	
	Bit	Bit weight
	0	1
	1~3	~
	4	16
	5~7	~
	8	256
	9~15	~
Query Syntax	STATus:OPERation[:EVENT]?	
Return Parameter	<NR1>	0~65535: Returns the bit weight of the Standard Operation Event Register.

Example SYST:OPER?
 >256
 Indicates that bit 8 has been latched.

STATus:PRESet (Set) →

Description Resets the Standard Event Enable Register, the Questionable Data Enable Register and the Standard Operation Enable Register to their default state.

Syntax STATus:PRESet

STATus:QUESTionable:CONDition → (Query)

Description Returns the contents of the Questionable Data Condition Register.

Bit	Bit weight	Description
0	1	Volt Overload
1	2	Current Overload
2~15	~	Not used

Query Syntax STATus:QUESTionable:CONDition?

Return Parameter <NR1> 0~65535: Returns the bit weight of the Questionable Data Condition Register.

Query Example STAT:QUES:COND?
 > 1
 Indicates there was a voltage overload.

Set →

→ Query

STATus:QUESTIONable:ENABLE

Description	Returns or sets the contents of the Questionable Data Enable Register.		
	Bit	Bit weight	Description
	0	1	Volt Overload
	1	2	Current Overload
	2~15	~	Not used
Syntax	STATus:QUESTIONable:ENABLE (0~65535)		
Query Syntax	STATus:QUESTIONable:ENABLE?		
Parameter / Return Parameter	<NR1>	0~65535: Indicates the bit weight of the Questionable Data Enable Register.	
Query Example	STAT:QUES:ENAB 3 Enables bit 1 and 2 of the Questionable Data Enable Register.		

STATus:QUESTIONable[:EVENT]

→ Query

Description	Returns the contents of the Questionable Data Event Register.		
	Bit	Bit weight	Description
	0	1	Volt Overload
	1	2	Current Overload
	2~15	~	Not used
Query Syntax	STATus:QUESTIONable[:EVENT]?		
Return Parameter	<NR1>	0~65535: Returns the bit weight of the Questionable Data Event Register.	
Example	SYST:QUES? >0 Indicates that no events have been latched.		

Common Commands

*IDN?	81
*ESE	81
*ESR?	82
*SRE	82
*STB?	83
*PSC	84
*OPC	84
*TST?	85
*CLS	85
*RST	85
*WAI	85

*IDN?

→ Query

Description Returns the manufacturer, model number, serial number and software version number.

Query Syntax *IDN?

Query Example *IDN?
>GWInstek,PCS-1000,xxxxxxxx,Vx.xx

Set →

*ESE

→ Query

Description Returns or sets the contents of the Standard Event Enable Register.

Bit	Bit weight	Description
0	1	Operation Complete
1	2	Not used
2	4	Query Error
3	8	Device Error
4	16	Execution Error
5	32	Command Error
6	64	Not used
7	128	Power On

Syntax	*ESE (0~255)
Query Syntax	*ESE?
Parameter / Return Parameter	<NR1> 0~255: Indicates the bit weight of the Standard Event Enable Register.
Query Example	*ESE 189 Enables all bits except for bit 1 and 6.

***ESR?** → Query

Description	Queries the Standard Event Register.		
	Bit	Bit weight	Description
	0	1	Operation Complete
	1	2	Not used
	2	4	Query Error
	3	8	Device Error
	4	16	Execution Error
	5	32	Command Error
	6	64	Not used
	7	128	Power On

Query Syntax	*ESR?
Parameter	<NR1> 0~255: Indicates the bit weight of the Standard Event Register.
Query Example	*ESR? >32 Indicates a command error was encountered.

***SRE** Set →
→ Query

Description	Returns or sets the contents of the Service Request Enable Register.		
	Bit	Bit weight	Description
	0	1	Not used
	1	2	Not used

	2	4	ERR: Error queue
	3	8	QUES: Questionable Data Register summary bit
	4	16	MAV: Message available bit
	5	32	ESB: Event summary bit
	6	~	~
	7	128	OPER: Standard Operation Register summary bit

Syntax *SRE (0~255)

Query Syntax *SRE?

Parameter / Return Parameter <NR1> 0~255: Indicates the bit weight of the Service Request Enable Register.

Query Example *SRE?
>188
Indicates that bits 2, 3, 4, 5 and 7 are enabled.

***STB?**



Description Queries the Status Byte Register.

Bit Summary	Bit	Bit weight	Description
	0	1	Not used
	1	2	Not used
	2	4	ERR: Error queue
	3	8	QUES: Questionable Data Register summary bit
	4	16	MAV: Message available bit
	5	32	ESB: Event summary bit
	6	64	MSS: Master summary bit of the Service Request Register and the Status Byte Register.
	7	128	OPER: Operation status register summary bit

Query Syntax *STB?

Parameter <NR1> 0~255: Indicates the bit weight of the Status Byte Register.

Query Example *STB?
 >4
 Indicates that there is a message in the error queue.

Set →

→ Query

***PSC**

Description The Power on Status Clear command enables the unit to clear the Service Request Enable, the Standard Event Enable and other event enable registers at power up.

Syntax *PSC (0|1)

Query Syntax *PSC?

Parameter / Return Parameter	0	Disabled
	1	Enabled

Query Example *PSC 0
 Disables the clearing of the event registers at power up.

Set →

→ Query

***OPC**

Description The Operation Complete command will set bit 0 of the Standard Event Register when all pending operations are complete. The OPC? query will return 1 when all pending operations are complete.

Syntax *OPC

Query Syntax *OPC?

Return Parameter	1	Enabled
------------------	---	---------

Query Example *OPC?
 >1
 Indicates that all pending operations are complete.

***TST?**

→ Query

Description Self-test query. This query will initiate a self-test and return the result.

Query Syntax *TST?

Parameter	0	All tests have passed.
	1	One of more tests have failed.

Query Example *TST?
>0
Indicates that all tests have passed.

***CLS**

Set →

Description The Clear Status command will clear the Status Byte Register by clearing the error queue, and register groups that connect to the Status Byte Register with a summary bit.

Syntax *CLS

***RST**

Set →

Description The Reset command will reset the unit to factory default settings.

Syntax *RST

***WAI**

Set →

Description The Wait command will make the unit wait until all pending operations are complete.

Syntax *WAI

Status Registers

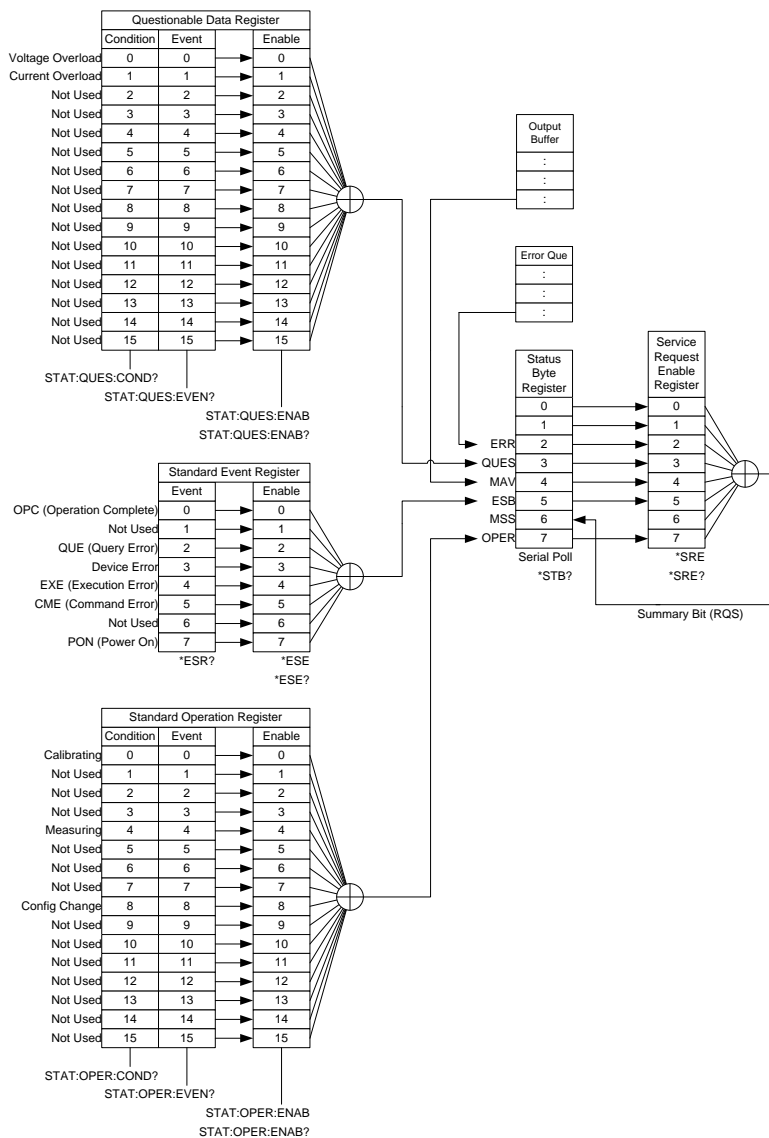

Error Messages

Command Errors	0, "No error"
	-101, "Invalid character"
	-102, "Syntax error"
	-103, "Invalid separator"
	-108, "Parameter not allowed"
	-109, "Missing parameter"
	-113, "Undefined header"
	-121, "Invalid character in number"
	-123, "Numeric overflow"
	-131, "Invalid suffix"
	-148, "Character data not allowed"
	-151, "Invalid string data"
Execution Errors	-222, "Data out of range"
	-224, "Illegal parameter value"
Device Specific Errors	-300, "Device-specific error"
	-330, "Self-test failed"
	-350, "Error queue overflow"
Query Errors	-410, "Query INTERRUPTED"
	-420, "Query UNTERMINATED"
	-521, "Input buffer overflow"
	-522, "Output buffer overflow"

APPENDIX

PCS Default Settings

The following default settings are the factory configuration settings when the unit first ships. See page 34 to restore the factory default settings.

Initial Settings	Default Setting
Current Meter	DCA
Voltage Meter	DCV
Current Range	Auto (Auto range only for 30mA, 300mA, 3A)
Voltage Range	Auto
Baud rate	9600
GPIB address	08
AD Speed	7 seconds (6½ digits)
AVG Mode	Shift
DCV AVG	10 (samples)
ACV AVG	10 (samples)
DCA AVG	10 (samples)
ACA AVG	10 (samples)
Autozero	Enable
Beeper	On

LED ASCII Table Character Set

Use the following table to read the LED display messages.

0	1	2	3	4	5	6	7	8	9	A	B	C	D
0	1	2	3	4	5	6	7	8	9	A	b	C	d
E	F	G	H	I	J	K	L	M	N	O	P	Q	R
E	F	G	H	I	J	K	L	M	N	O	P	Q	R
S	T	U	V	W	X	Y	Z	()	+	-	,		
S	T	U	V	W	X	Y	Z	()	+	-	,		

PCS-1000 Specifications

The specifications apply when the PCS is powered on for at least 30 minutes.

General

Power Supply	100 V / 120 V / 220 V / 240 V \pm 10%
Power Line Frequency	50/60Hz
Operating Environment	Full accuracy for 0°C to 50°C, Full accuracy to 80% R.H. at 40°C
Storage Environment	-40°C to 70°C
Power Consumption	Max 35VA
Dimensions	210mm (W) * 80mm (H) * 390mm (D)
Weight	Approximately 6 kg

DC Characteristics

DC Voltage	Range	1 Year 23°C \pm 5°C	Temperature Coefficient/°C
	200.0000 mV		0.0050 + 0.0035
2.000000 V		0.0050 + 0.0010	0.0005 + 0.0001
20.00000 V		0.0050 + 0.0010	0.0005 + 0.0001
200.0000 V		0.0050 + 0.0010	0.0005 + 0.0001
1000.000 V		0.0050 + 0.0020	0.0005 + 0.0001
Accuracy specification : \pm (% of reading + % of range)			
Voltage input Resistance: 10M Ω for all DC Voltage ranges			

DC Current	Range	Burden Voltage	1 Year 23°C \pm 5°C	Temperature Coefficient/°C
	30.00000 mA	<0.4 V		0.01 + 0.005
300.0000 mA	<0.5 V		0.01 + 0.005	0.001 + 0.002
3.000000 A	<0.8 V		0.01 + 0.005	0.001 + 0.002
30.00000 A	<0.8 V		0.01 + 0.005	0.001 + 0.002
300.0000 A	<0.8 V		0.02 + 0.005	0.001 + 0.002
Accuracy specification : \pm (% of reading + % of range)				

AC Characteristics

True RMS AC Voltage	Range	Frequency	1 Year 23 °C ± 5 °C	Temperature Coefficient/°C
	200.0000 mV			
2.000000 V	45 Hz - 2 kHz		0.5 + 0.05	0.005 + 0.005
20.00000 V	2 kHz - 10 kHz		1.0 + 0.05	0.005 + 0.005
200.0000 V	10 kHz - 20 kHz		2.0 + 0.10	0.005 + 0.005
600.000 V				0.005 + 0.005
Accuracy specification : ± (% of reading + % of range)				

True RMS AC Current (AC+DC)	Range	Frequency	1 Year 23 °C ± 5 °C	Temperature Coefficient/°C
	30.00000 mA	45 Hz - 2 kHz		0.5 + 0.05
300.0000 mA	2 kHz - 10 kHz		1.0 + 0.05	0.03 + 0.006
3.000000 A				0.03 + 0.006
30.00000 A	45 Hz - 400 Hz		0.5 + 0.05	0.03 + 0.006
300.0000 A				0.03 + 0.006
Accuracy specification : ± (% of reading + % of range)				

Current Monitor Accuracy

Range	Shunt Value	DC Accuracy	AC Accuracy ≤ 400 Hz	Max Input DC/AC rms
30.00000 mA	10 Ω	0.01%	0.1%	30 mA
300.0000 mA	1 Ω	0.01%	0.1%	300 mA
3.000000 A	0.1 Ω	0.01%	0.1%	3 A
30.00000 A	0.01 Ω	0.01%	0.1%	30 A
300.0000 A	0.001 Ω	0.02%	0.1%	300 A

PCS Dimensions

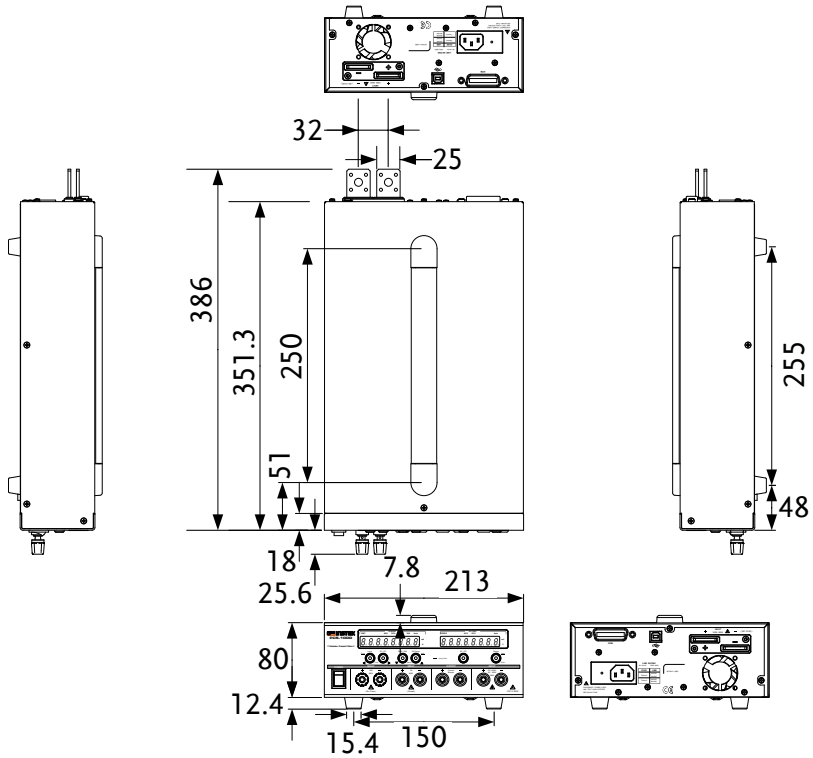

scale = mm.

Declaration of Conformity

We

GOOD WILL INSTRUMENT CO., LTD.

No. 7-1, Jhongsing Rd, Tucheng Dist., New Taipei City 236, Taiwan

GOOD WILL INSTRUMENT (SUZHOU) CO., LTD.

No. 69 Lushan Road, Suzhou New District Jiangsu, China.

declare that the below mentioned product

Type of Product: Digital Current and Voltage Meter

Model Number: PCS-1000

are herewith confirmed to comply with the requirements set out in the Council Directive on the Approximation of the Law of Member States relating to Electromagnetic Compatibility (2004/108/EC) and Low Voltage Directive (2006/95/EC).

For the evaluation regarding the Electromagnetic Compatibility and Low Voltage Directive, the following standards were applied:

◎ EMC	
EN 61326-1: EN 61326-2-1:	Electrical equipment for measurement, control and laboratory use -- EMC requirements (2013)
Conducted & Radiated Emission EN 55011: 2009+A1:2010	Electrostatic Discharge EN 61000-4-2: 2009
Current Harmonics EN 61000-3-2: 2006+A1: 2009+A2: 2009	Radiated Immunity EN 61000-4-3: 2006+A1:2008+A2:2010
Voltage Fluctuations EN 61000-3-3: 2008	Electrical Fast Transients IEC 61000-4-4: 2012
-----	Surge Immunity EN 61000-4-5: 2006
-----	Conducted Susceptibility EN 61000-4-6: 2009
-----	Power Frequency Magnetic Field EN 61000-4-8: 2010
-----	Voltage Dip/ Interruption EN 61000-4-11: 2004

Low Voltage Equipment Directive 2006/95/EC	
Safety Requirements	EN 61010-1: 2010 EN 61010-2-030: 2010

INDEX

AC/DC Current	25	LCD conversion.....	88
AC/DC Voltage	26	List of features	9
Accessories	10	Overview	9
AD speed	37	Power on/off	
Autozero function.....	40	safety instruction.....	5
Average mode	38	Power up	19
Average number settings.....	39	Rack mount.....	20
Baudrate.....	35	Rear panel	16
Beeper settings	41	Remote control	42
Caution symbol.....	4	Command list.....	59
Cleaning the instrument	5	Command syntax	56
Connections	22	GPIB configuration.....	44
Current monitor	30	return to local mode.....	55
Current range selection.....	25	USB configuration	50
Declaration of conformity.....	92	Restore default settings	34
Default settings	34, 88	Service operation	
Dimensions	91	about disassembly	5
Display format	88	Software version	33
Disposal instructions	6	Specifications	89
EN61010		Status Registers	86
measurement category	5	UK power cord.....	7
pollution degree.....	6	USB driver installation	48
Environment		USB function check.....	53
safety instruction	6	Voltage range selection	27
Error messages	87	Warning symbol.....	4
Front panel diagram.....	11	Waveform type crest factor	
Function menu	31	comparison	29
GPIB address	36	Waveform type voltage	
GPIB function check	45	comparison	28
Ground		Wire gauge chart	21
symbol	4		