

DATA SHEET for LED

LG30240

Part No.	LG30240	
Emitted Color	Lens Color	Chip Material
Green	Green Diffused	GaP

Package Dimensions :

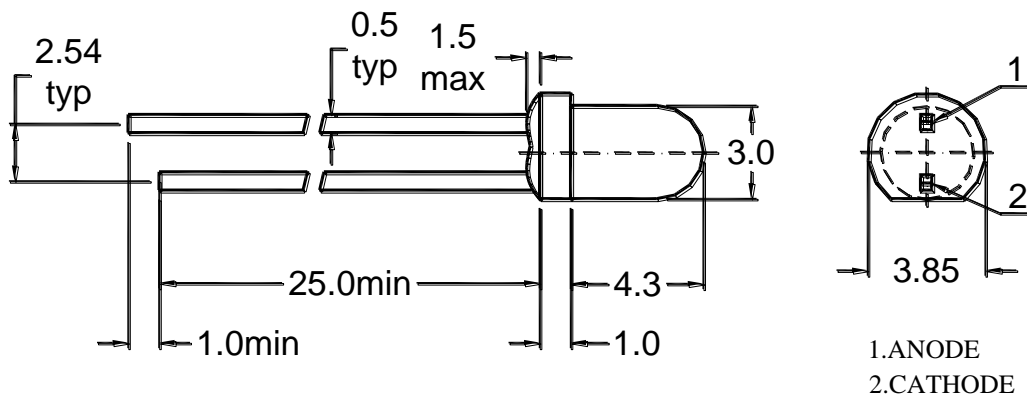

Note :

1. All dimensions are in millimeters(mm)
2. Tolerance is ± 0.25 mm unless otherwise noted

Absolute Maximum Rating of Each Segment (Ta = 25 °C)

Parameter	Symbol	Maximum Rating	Unit
Power Dissipation	P_d	60	mW
Pulse Forward Current (Duty 1/10 @ 1kHz)	I_{FP}	70	mA
Continuous Forward Current	I_F	20	mA
Reverse Voltage	V_R	5	V
Operation Temperature	T_{opr}	-30°C ~85°C	°C
Storage Temperature	T_{stg}	-40°C ~100°C	°C
Soldering Temperature	T_{sol}	260 \pm 5	°C

Note : Soldering Time ≤ 5 seconds

Electron-Optical Characteristics of Each Segment (Ta = 25°C)

Parameter	Symbol	Min.	Typ.	Max.	Unit	Test Condition
Luminous Intensity	I _v		60		mcd	I _F =20 mA
Forward Voltage	V _F		2.2	2.5	V	I _F =20 mA
Reverse Current	I _R			20	μA	V _R =5V
Dominant Wavelength	λ _d		570		nm	I _F =20 mA
Peak Emission Wavelength	λ _p		565		nm	I _F =20 mA
Spectral Line Half Width	Δλ		30		nm	I _F =20 mA
Viewing Angle	2θ _{1/2}		35		deg	I _F =20 mA

Typical Electro- Optical Characteristic Curves :

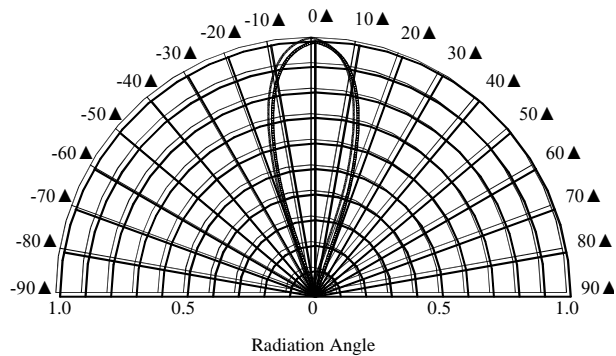
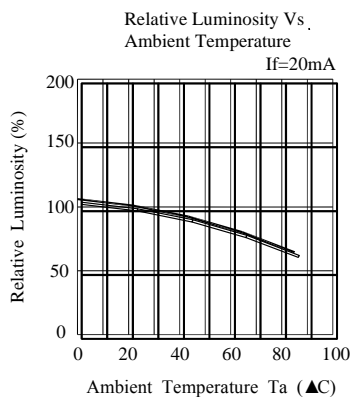
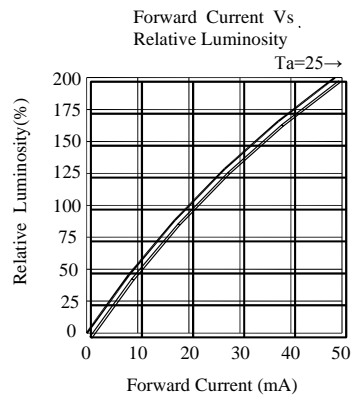
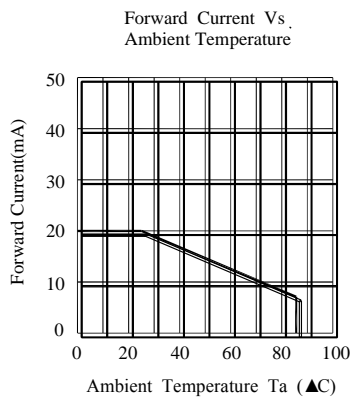
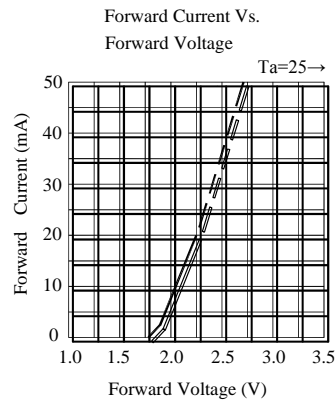
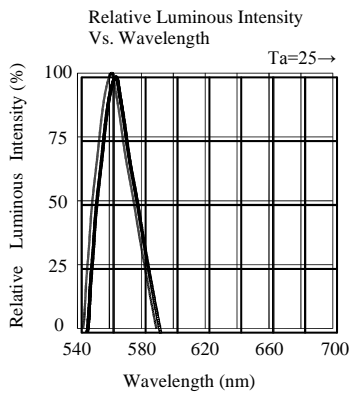

Reliability Test Items and Conditions

Test Item	Test Conditions	Duration	Sample	Ac/Re
Temperature Cycle	-40°C(30 min.) ~ 25°C(5 min.) ~ 100°C(30 min.) ~ 25°C(5 min.)	50 cycles	100	0/1
High Temp. Storage	Ta=100°C	1,000 hours	100	0/1
Temp. & Humidity Test	Ta=85°C RH=85%	1,000 hours	100	0/1
Low Temp. Storage	Ta=-40°C	1,000 hours	100	0/1
Operating Life Test	Ta=25±5°C DC IF=20mA	1,000 hours	100	0/1
Solder Heat	Tsol=260±5°C, 10s	1 time	20	0/1

Precautions In Use

A. Soldering Conditions

1. Maximum allowable soldering conditions are.

Solder dipping : 260 °C max., 5 seconds max., one time.

Soldering iron : 350 °C max., 5 seconds max., one time.

2. In soldering, do not put any stress on the lead frame, particularly when heated.

B. Lead frame Forming and Use

1. When mounting the LEDs onto a printed circuit board ,the holes on the circuit board should be exactly aligned with the leads of the LEDs.

2. Please avoid conditions which may cause the LED to corrode, tarnish or discolor. This corrosion or discoloration may cause difficulty during soldering operations. It is recommended that the LEDs be used as soon as possible.

3. Please avoid rapid transitions in ambient temperature, especially, in high humidity environments.

Notes :

1. Above specification may be changed without notice. We will reserve authority on material change for above specification.

2. When using this product, please observe the absolute maximum ratings and the instructions for the specification sheets. We assume no responsibility for any damage resulting from use of the product which does not comply with the instructions included in the specification sheets.