



**MODEL NO. :** TM097TDH02

**ISSUED DATE:** 2012-5-15

**VERSION :** Ver. 2.0

- Preliminary Specification
- Final Product Specification

**Customer :** \_\_\_\_\_

Approved by	Notes

**SHANGHAI AVIC Confirmed :**

Prepared by	Checked by	Approved by
Xugang Pan 2012/5/15	TonyXiao 2012/5/15	Hyman Chen 2012/5/15

This technical specification is subjected to change without notice



## Table of Contents

Table of Contents.....	2
Record of Revision.....	3
1 General Specifications.....	4
2 Input/Output Terminals.....	5
3 Absolute Maximum Ratings.....	6
4 Electrical Characteristics.....	7
5 Timing Chart.....	10
6 Optical Characteristics.....	15
7 Environmental / Reliability Test.....	18
8 Mechanical Drawing.....	19
9 Packing drawing.....	20
10 Precautions for Use of LCD Modules.....	21

AVIC CONFIDENTIAL





## 1 General Specifications

Feature		Spec
Display Spec	Size	9.7 inch
	Resolution	1024 (RGB) x 768
	Interface	LVDS 6-bit
	Color Depth	262K
	Technology Type	a-Si
	Pixel Pitch (mm)	0.192 (H) x 0.192 (V)
	Pixel Configuration	R.G.B. Vertical Stripe
	Display Mode	TM with Normally White
	Surface Treatment(Up Polarizer)	Clear
	Viewing Direction	3 o'clock
	Gray Scale Inversion Direction	9 o'clock
Mechanical Characteristics	LCM (W x H x D) (mm)	210.20 (W) x166.30(H)x3.5(D)
	Active Area(mm)	196.61 (W) x 147.46 (H)
	With /Without TSP	Without TSP
	Weight (g)	200
	LED Numbers	36LEDS

Note 1: Viewing direction for best image quality is different from TFT definition. There is a 180 degree shift.

Note 2: Requirements on Environmental Protection: RoHS

Note 3: LCM weight tolerance: +/- 5%



## 2 Input/Output Terminals

### 2.1 CN1 of FPC

Pin No.	Symbol	I/O	Function	Remarks
1	GND	P	Ground	-
2	VCC	P	Power supply 3.3V	-
3	VCC	P	Power supply 3.3V	-
4	V EEDID	P	DDC 3.3V	-
5	GSP	-	GSP	-
6	Clk EEDID	I	DDC clock	-
7	Data EEDID	I	DDC data	-
8	R <sub>IN</sub> 0-	I	Negative LVDS differential data input	-
9	R <sub>IN</sub> 0+	I	Positive LVDS differential data input	-
10	GND	P	Ground	-
11	R <sub>IN</sub> 1-	I	Negative LVDS differential data input	-
12	R <sub>IN</sub> 1+	I	Positive LVDS differential data input	-
13	GND	P	Ground	-
14	R <sub>IN</sub> 2-	I	Negative LVDS differential data input	-
15	R <sub>IN</sub> 2+	I	Positive LVDS differential data input	-
16	GND	P	Ground	-
17	Clk <sub>IN</sub> -	I	Negative LVDS differential data input	-
18	Clk <sub>IN</sub> +	I	Positive LVDS differential data input	-
19	GND	P	Ground	-
20	NC	-	No connection	-
21	Vdc	P	LED Anode (positive)	-
22	Vdc	P	LED Anode (positive)	-
23	NC	-	No connection	-
24	Vdc 1	P	LED Cathode (Negative)	-
25	Vdc 2	P	LED Cathode (Negative)	-
26	Vdc 3	P	LED Cathode (Negative)	-
27	Vdc 4	P	LED Cathode (Negative)	-
28	Vdc 5	P	LED Cathode (Negative)	-
29	Vdc 6	P	LED Cathode (Negative)	-
30	NC	-	No connection	-

Note: I/O definition.

I---Input pin, O---Output pin, P--- Power/Ground, N--- No Connection



### 3 Absolute Maximum Ratings

AGND= GND=0V, Ta = 25°C

Item	Symbol	Min	Max	Unit	Remark
Power Voltage	VCC	-0.5	5.0	V	
Operating Temperature	T <sub>OPR</sub>	-20	70	°C	
Storage Temperature	T <sub>STG</sub>	-30	80	°C	

AVIC CONFIDENTIAL



## 4 Electrical Characteristics

### 4.1 Recommended Operating Condition

AGND=GND=0V, Ta = 25°C

Item	Symbol	Min	Typ	Max	Unit	Remark
Digital Supply Voltage	VCC	3.0	3.3	3.6	V	

Note: The value is for design stage only.

AVIC CONFIDENTIAL



### 4.2 Recommended Driving Condition for Backlight

Ta=25°C

Item	Symbol	Min	Typ	Max	Unit	Remark
Forward Current	I <sub>F</sub>		120		mA	36 LEDs (6 LED Serial, 6 LED Parallel)
Forward Voltage	V <sub>F</sub>		19.2		V	
Operating Life Time	-		30000	-	Hrs	

Note1: For each LED: I<sub>F</sub> (1/6) =20mA, V<sub>F</sub> (1/6) =3.2V.

Note2: Under LCM operating, the stable forward current should be inputted. And forward voltage is for reference only.

Note3: I<sub>F</sub> is defined for one channel LED. Optical performance should be evaluated at Ta=25°C only If LED is driven by high current, high ambient temperature & humidity condition. The life time of LED will be reduced. Operating life means brightness goes down to 50% initial brightness. Typical operating life time is estimated data.

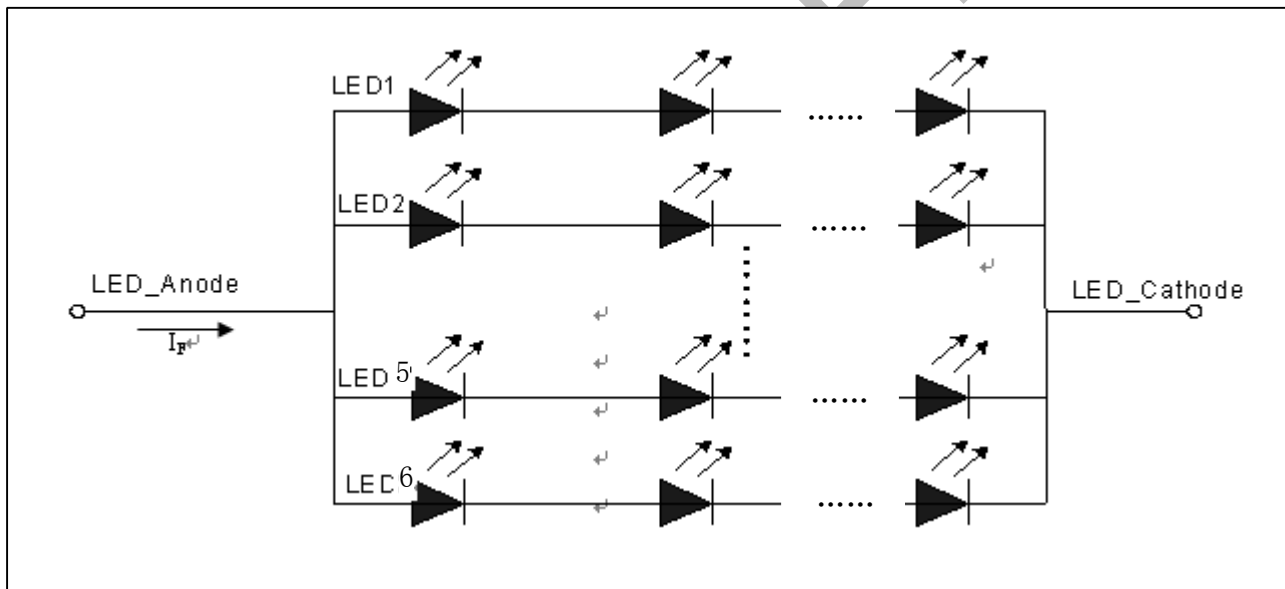

Note4: The LED driving condition is defined for each LED module.





4.3 Power Consumption

AGND=GND=0V, Ta = 25°C

Item	Symbol	Condition	Min	Typ	Max	Unit	Remark
Power Supply Current	I <sub>DVDD</sub>	VCC=3.3V	-	271	-	mA	
Power Consumption	Panel&Gamma		-	894.3	-	mW	
	Backlight		-	2.304	-	W	
	Total		-	3.198	-	W	

AVIC CONFIDENTIAL



## 5 Timing Chart

### 5.1 TFT-LCD Input Timing

#### DC specification

Parameter	Symbol	Min.	Typ.	Max.	Unit	Condition
Differential input high threshold voltage	$R_{xVTH}$			+0.1	V	$R_{xVCM} = 1.2V$
Differential input low threshold voltage	$R_{xVTL}$	-0.1			V	
Input voltage range (singled-end)	$R_{xVIN}$	0		2.4	V	
Differential input common mode voltage	$R_{xVCM}$	$ V_{ID} /2$		$2.4 -  V_{ID} /2$	V	
Differential input voltage	$ V_{ID} $	0.2		0.6	V	
Differential input leakage current	$R_{V_{xIIZ}}$	-10		+10	$\mu A$	
LVDS Digital Operating Current	Iddlvs	-	40	50	mA	Fclk=65 MHz, VDD=3.3V
LVDS Digital Stand-by Current	Istlvs	-	10	50	$\mu A$	Clock & all Functions are stopped

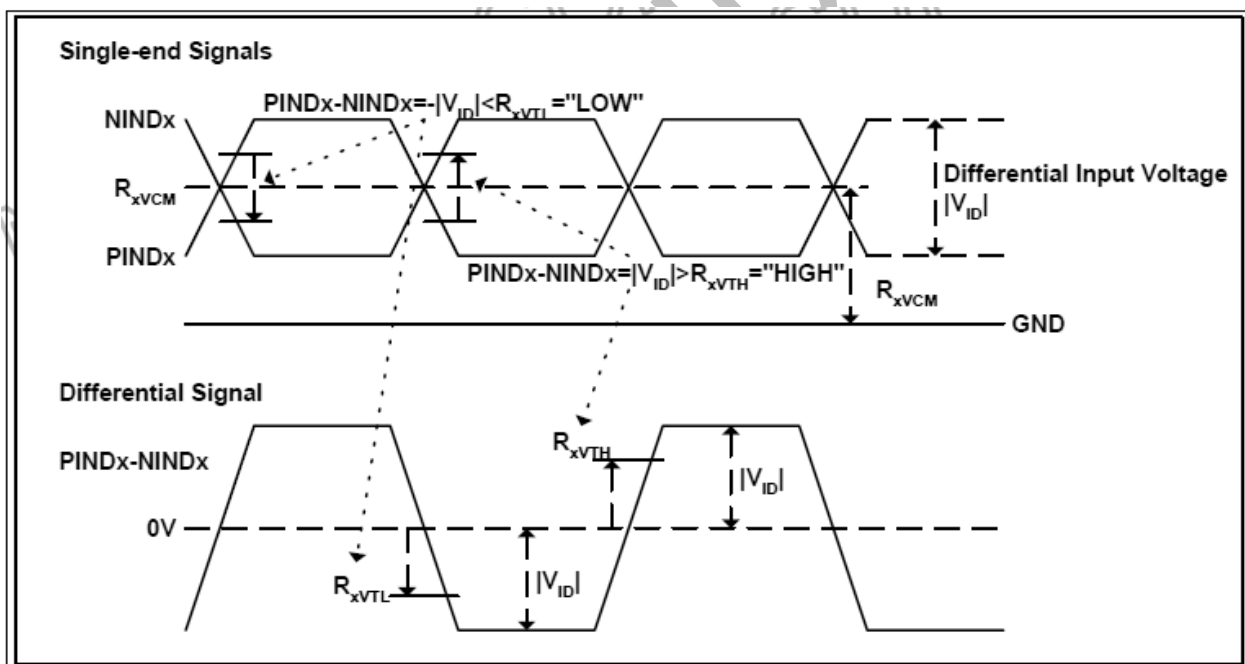



AC specification

Parameter	Symbol	Min.	Typ.	Max.	Unit	Condition
Clock frequency	$R_{xFCLK}$	20		71	MHz	
Input data skew margin	$T_{RSKM}$	500			pS	$ V_{ID}  = 400mV$ $R_{xVCM} = 1.2V$ $R_{xFCLK} = 71 MHz$
Clock high time	$T_{LVCH}$		$4/(7 * R_{xFCLK})$		ns	
Clock low time	$T_{LVCL}$		$3/(7 * R_{xFCLK})$		ns	
PLL wake-up time	$T_{enPLL}$			150	uS	

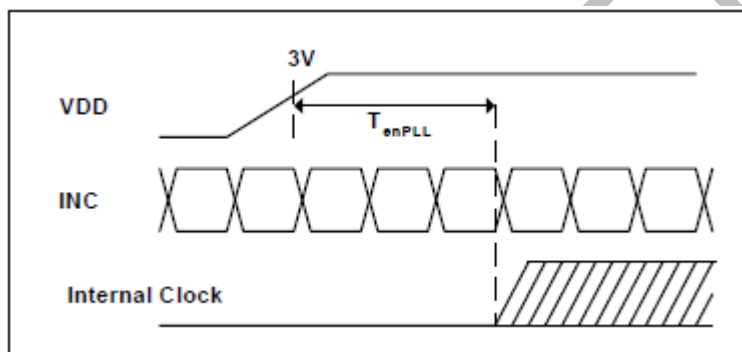
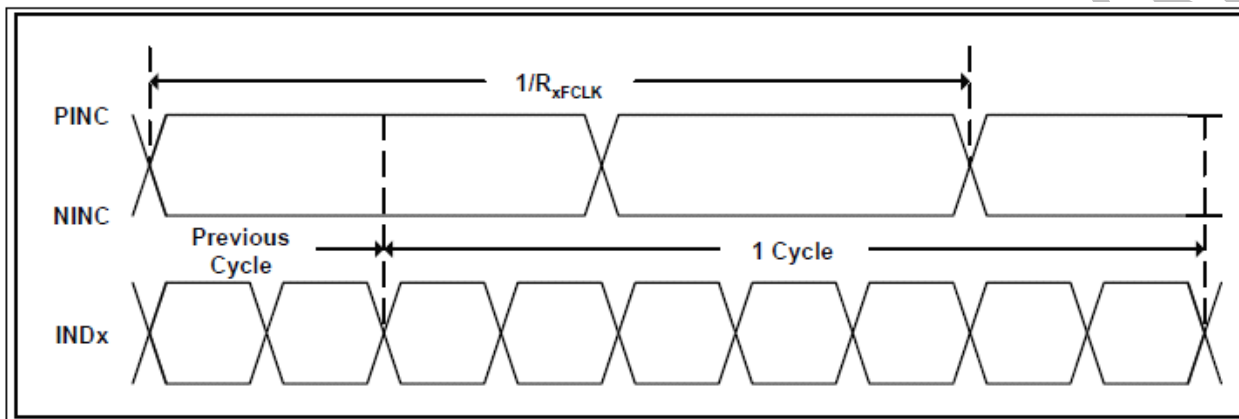

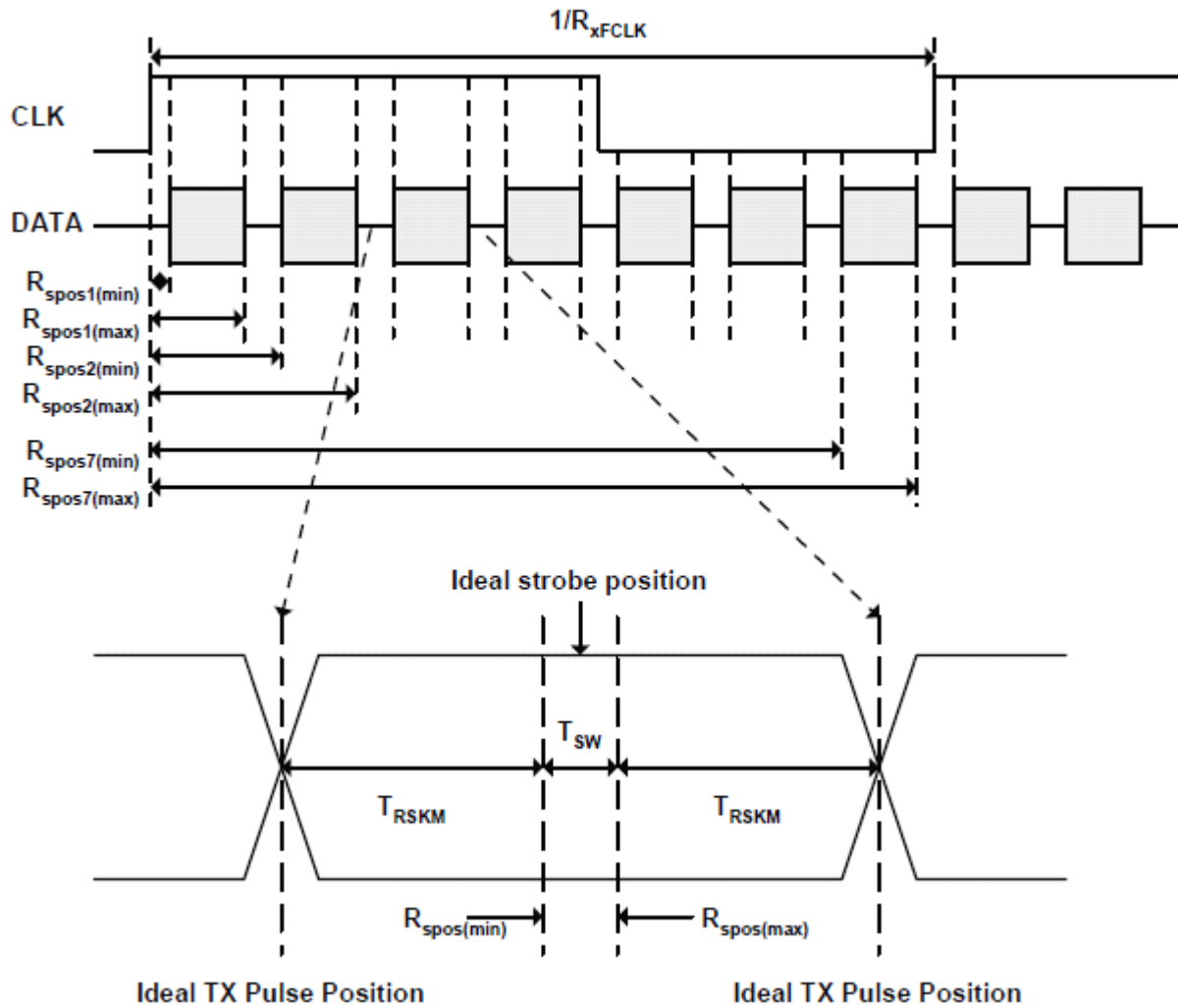

$T_{RSKM}$ : Receiver strobe margin  
 $R_{SPOS}$ : Receiver strobe position  
 $T_{SW}$ : Strobe width (Internal data sampling window)

SSC tolerance of LVDS receiver						
Symbol	parameter	condition	Min.	Typ.	Max.	Units
SSCMF	Modulation Frequency		23		93	KHz
SSCMR	Modulation Rate	LVDS clock = 71MHz center spread			$\pm 3$	%



5.2 Timing Setting Of Signal

Input Timing Of Connector

Parameter	Symbol	Min	Typ	Max	Unit	Remark
DCLK	fclk	52	65	71	MHZ	
Hsync	thd	1024			tclk	
	th	1114	1344	1400	tclk	
	thb+thfp	90	320	376	tclk	
Vsync	tvd	768			thp	
	tv	778	806	845	thp	
	tvbp+tvfp	10	38	77	thp	

Date input:

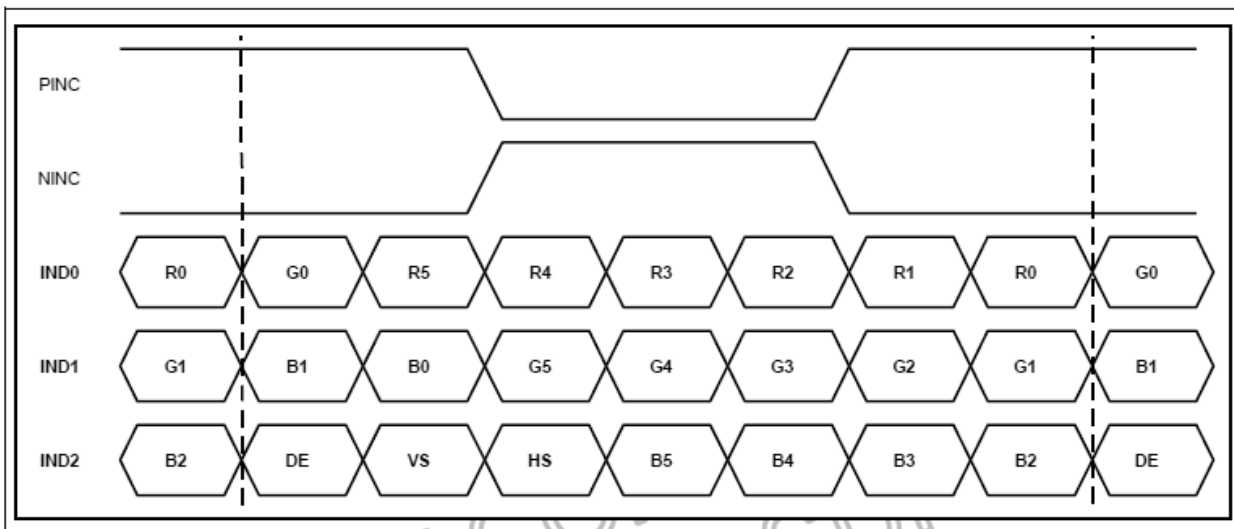



### 5.3 POWER ON/OFF SEQUENCE

Item	Symbol	Min	Typ	Max	Unit	Remark
VDD to signal starting	Tp1	5	-	50	ms	
Signal starting to backlight on	Tp2	150	-	-	ms	
Signal off to VDD 3.0V	Tp3	5	-	50	ms	
Backlight off to signal off	Tp4	150	-	-	ms	

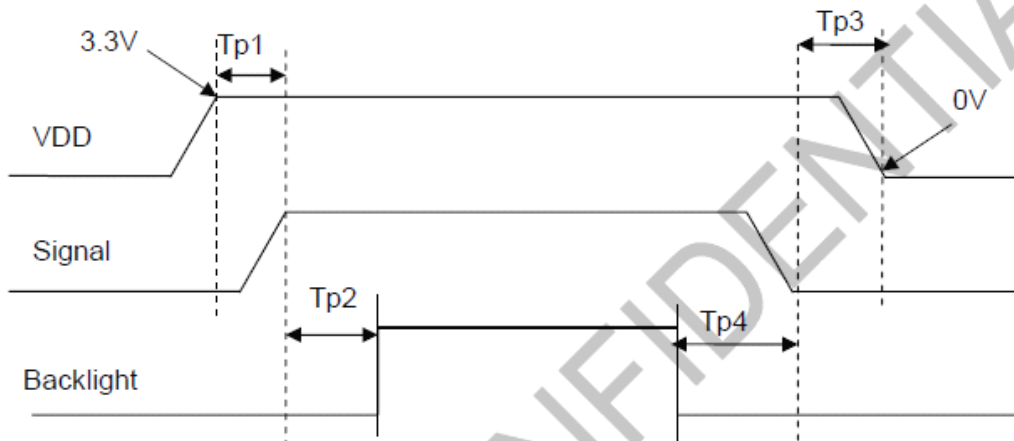



## 6 Optical Characteristics

Ta=25°C

Item	Symbol	Condition	Min	Typ	Max	Unit	Remark	
View Angles	$\theta T$	$CR \geq 10$	60	70	-	Degree	Note 2	
	$\theta B$		60	70	-			
	$\theta L$		60	70	-			
	$\theta R$		50	60	-			
Contrast Ratio	CR	$\theta=0^\circ$	400	500	-		Note1 Note3	
Response Time	$T_{ON}$	25°C	-	20	25	ms	Note1 Note4	
	$T_{OFF}$							
Chromaticity	White	Backlight is on	x	0.261	0.311	0.361		Note1 Note5
			y	0.266	0.316	0.366		
	Red		x	0.533	0.583	0.633		
			y	0.296	0.346	0.396		
	Green		x	0.298	0.348	0.398		
			y	0.518	0.568	0.618		
	Blue		x	0.101	0.151	0.201		
			y	0.039	0.089	0.139		
Uniformity	U		75	--	%	Note1 Note6		
NTSC			45	50	-	%	Note 5	
Luminance	L		280	350	-	cd/m <sup>2</sup>	Note1 Note7	

Test Conditions:

1.  $I_F=120\text{ mA}$ ,  $V_F=19.2\text{ V}$  and the ambient temperature is 25°C.
2. The test systems refer to Note 1 and Note 2.
3. The Transmittance and NTSC are the emulated values base on the panel with normal EWW polarizer and C-Light, and when using Normal LED back light they will be to decrease.



Note 1: Definition of optical measurement system.

The optical characteristics should be measured in dark room. After 5 Minutes operation, the optical properties are measured at the center point of the LCD screen. All input terminals LCD panel must be ground when measuring the center area of the panel.

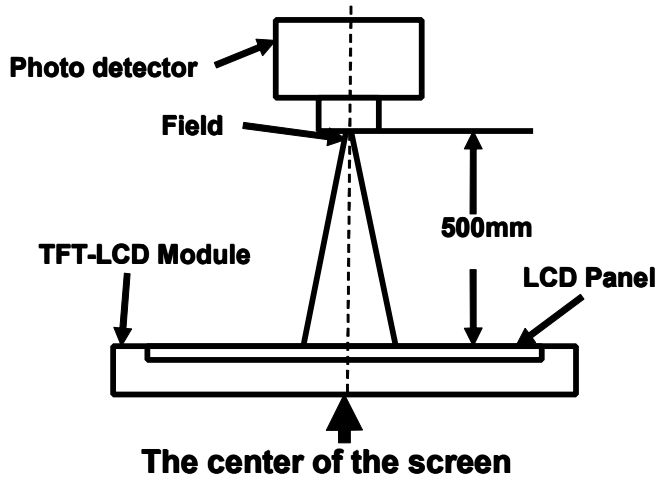

Item	Photo detector	Field
Contrast Ratio	BM-5A	1°
Luminance		
Lum Uniformity		
Chromaticity	SR-3A	
Response Time	TRD100	-

Note 2: Definition of viewing angle range and measurement system.

viewing angle is measured at the center point of the LCD by CONOSCOPE(ergo-80).

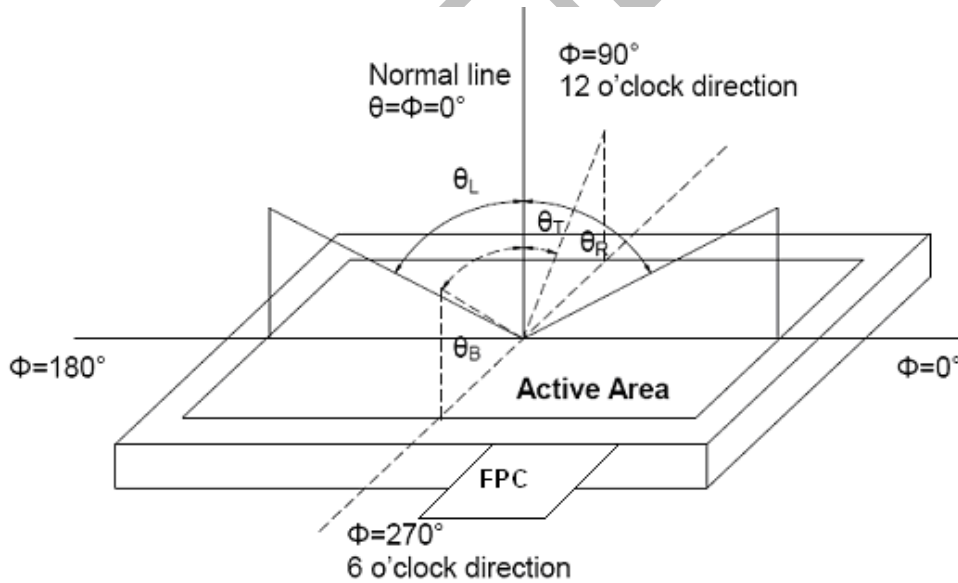

Note 3: Definition of contrast ratio

$$\text{Contrast ratio (CR)} = \frac{\text{Luminance measured when LCD is on the "White" state}}{\text{Luminance measured when LCD is on the "Black" state}}$$

“White state “: The state is that the LCD should drive by  $V_{white}$ .

“Black state”: The state is that the LCD should drive by  $V_{black}$ .

$V_{white}$ : To be determined     $V_{black}$ : To be determined.





Note 4: Definition of Response time

The response time is defined as the LCD optical switching time interval between “White” state and “Black” state. Rise time ( $T_{ON}$ ) is the time between photo detector output intensity changed from 90% to 10%. And fall time ( $T_{OFF}$ ) is the time between photo detector output intensity changed from 10% to 90%.

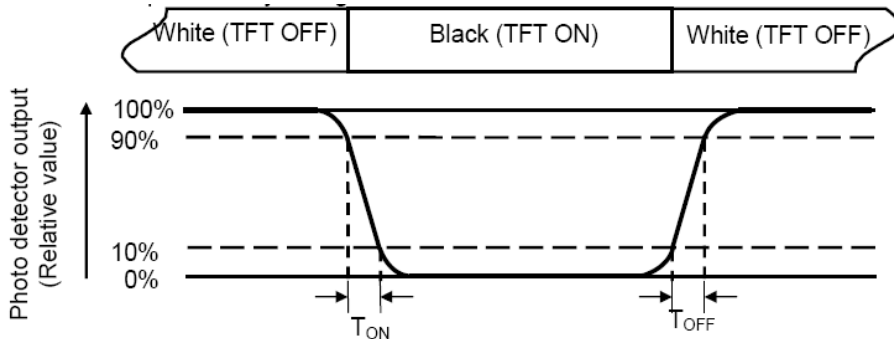

Note 5: Definition of color chromaticity (CIE1931)

Color coordinates measured at center point of LCD.

Note 6: Definition of Luminance Uniformity

Active area is divided into 9 measuring areas (Refer Fig. 2). Every measuring point is placed at the center of each measuring area.

$$\text{Luminance Uniformity (U)} = L_{\min} / L_{\max}$$

L-----Active area length W----- Active area width

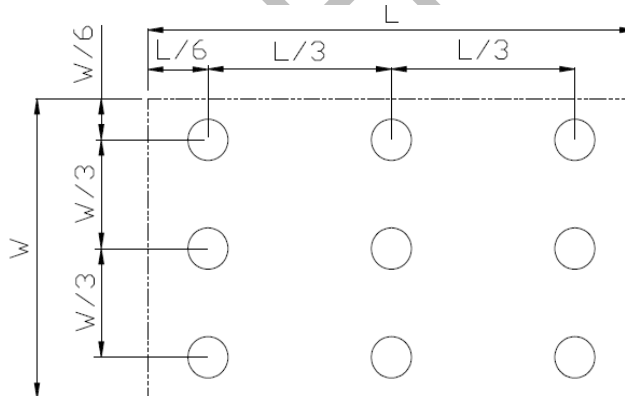

$L_{\max}$ : The measured Maximum luminance of all measurement position.

$L_{\min}$ : The measured Minimum luminance of all measurement position.

Note 7: Definition of Luminance:

Measure the luminance of white state at center point.



## 7 Environmental / Reliability Test

No	Test Item	Condition	Remarks
1	High Temperature Operation	Ts = +50°C, 96 hours	IEC60068-2-1:2007 GB2423.2-2008
2	Low Temperature Operation	Ta = 0°C, 96 hours	IEC60068-2-1:2007 GB2423.1-2008
3	High Temperature Storage	Ta = +60°C, 96 hours	IEC60068-2-1:2007 GB2423.2-2008
4	Low Temperature Storage	Ta = -20°C, 96 hours	IEC60068-2-1:2007 GB2423.1-2008
5	Storage at High Temperature and Humidity	Ta = +60°C, 90% RH max,96hours	IEC60068-2-78 :2001 GB/T2423.3—2006
6	Thermal Shock (non-operation)	-20°C 30 min~+60°C 30 min, Change time:5min, 20 Cycle	Start with cold temperature, End with high temperature, IEC60068-2-14:1984,G B2423.22-2002
7	ESD	C=150pF,R=330Ω,5point/panel Air:±8Kv,5times; Contact:±4Kv,5times (Environment:15°C~35°C, 30%~60%.86Kpa~106Kpa)	IEC61000-4-2:2001 GB/T17626.2-2006
8	Vibration Test	Frequency range:10~55Hz Stroke:1.5mm Sweep:10Hz~55Hz~10Hz 2 hours for each direction of X.Y.Z. (6 hours for total)	IEC60068-2-6:1982 GB/T2423.10—1995
9	Mechanical Shock (Non Op)	Half Sine Wave 60G 6ms, ±X,±Y,±Z 3times for each direction	IEC60068-2-27:1987 GB/T2423.5—1995
10	Package Drop Test	Height:50cm, 1corner,3edges,6surfaces	IEC60068-2-32:1990 GB/T2423.8—1995

Note1: Ts is the temperature of panel's surface.

Note2: Ta is the ambient temperature of samples.

Note3: In the standard condition,there is not display function NG issue occurred.All the cosmetic specification is judged before the reliability stress.



# 8 Mechanical Drawing

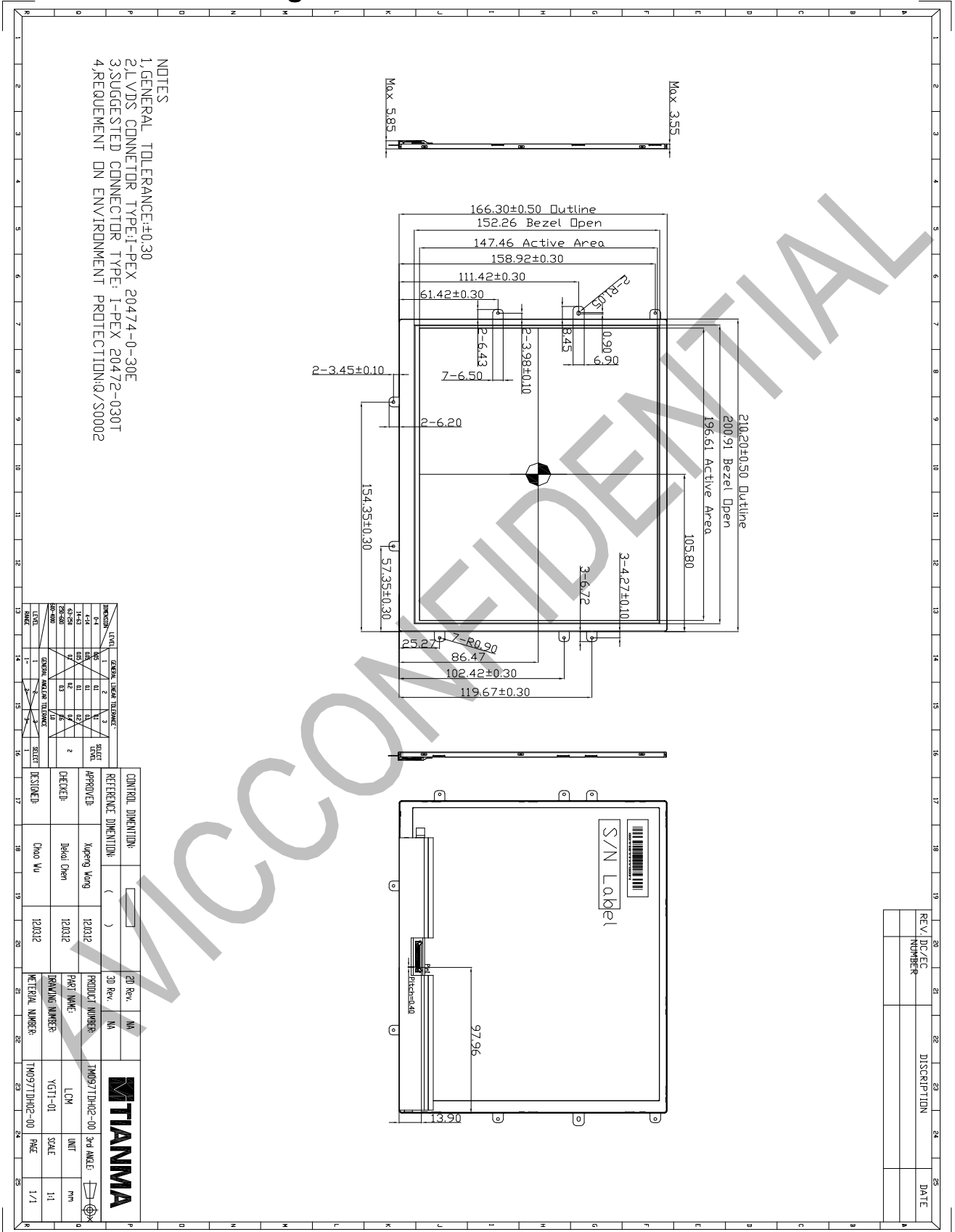

The information contained herein is the exclusive property of SHANGHAI AVIC OPTOELECTRONICS Corporation, and shall not be distributed, reproduced, or disclosed in whole or in part without prior written permission of SHANGHAI AVIC OPTOELECTRONICS Corporation.



### 9 Packing drawing

No	Item	Model (Material)	Dimensions(mm)	Unit Weight(Kg)	Quantity	Remark	
1	LCM module	TM097TDH02	210.2X166.3X3.55	0.2	60		
2	Tray	PET	519 X437 X20	0.295	16		
3	Dust-Proof Bag	PE	830 X 525 X 0.09	0.05	1		
4	EPE Spacer	EPE	544 X426 X15	0.2	2		
5	EPE Spacer	EPE	462 X246 X15	0.1	2		
6	EPE Spacer	EPE	514 X246 X15	0.1	2		
7	EPE Spacer	EPE	451 X368 X1	0.02	15		
8	Carton	Corrugated paper	565 X 483 X 312	1.4	1		
9	Total weight	19.27kg±5%					

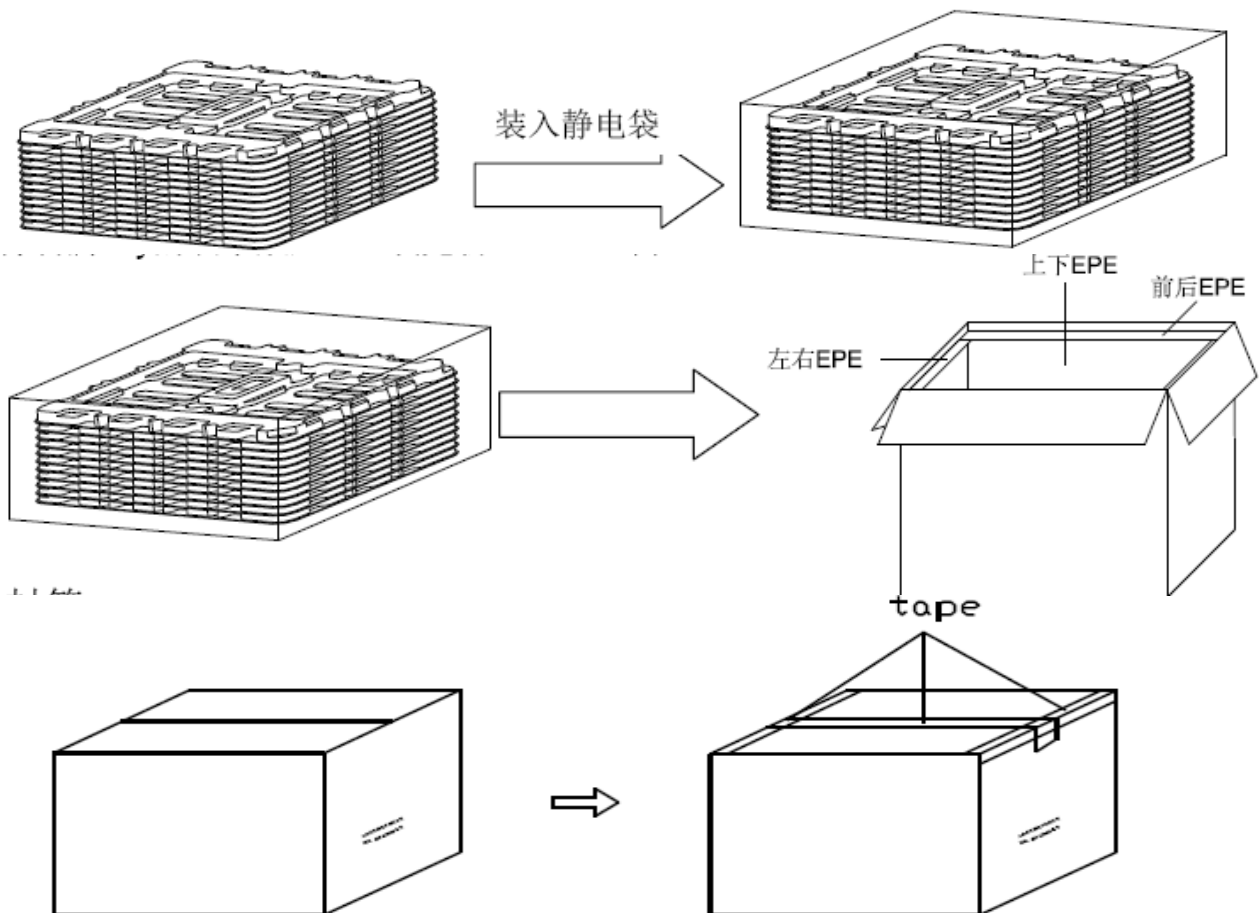

The information contained herein is the exclusive property of SHANGHAI AVIC OPTOELECTRONICS Corporation, and shall not be distributed, reproduced, or disclosed in whole or in part without prior written permission of SHANGHAI AVIC OPTOELECTRONICS Corporation.



## 10 Precautions for Use of LCD Modules

### 10.1 Handling Precautions

10.1.1 The display panel is made of glass. Do not subject it to a mechanical shock by dropping it from a high place, etc.

10.1.2 If the display panel is damaged and the liquid crystal substance inside it leaks out, be sure not to get any in your mouth, if the substance comes into contact with your skin or clothes, promptly wash it off using soap and water.

10.1.3 Do not apply excessive force to the display surface or the adjoining areas since this may cause the color tone to vary.

10.1.4 The polarizer covering the display surface of the LCD module is soft and easily scratched. Handle this polarizer carefully.

10.1.5 If the display surface is contaminated, breathe on the surface and gently wipe it with a soft dry cloth. If still not completely clear, moisten cloth with one of the following solvents:

- Isopropyl alcohol
- Ethyl alcohol

Solvents other than those mentioned above may damage the polarizer. Especially, do not use the following:

- Water
- Ketone
- Aromatic solvents

10.1.6 Do not attempt to disassemble the LCD Module.

10.1.7 If the logic circuit power is off, do not apply the input signals.

10.1.8 To prevent destruction of the elements by static electricity, be careful to maintain an optimum work environment.

10.1.8.1 Be sure to ground the body when handling the LCD Modules.

10.1.8.2 Tools required for assembly, such as soldering irons, must be properly ground.

10.1.8.3 To reduce the amount of static electricity generated, do not conduct assembly and other work under dry conditions.

10.1.8.4 The LCD Module is coated with a film to protect the display surface. Be care when peeling off this protective film since static electricity may be generated.

### 10.2 Storage precautions

10.2.1 When storing the LCD modules, avoid exposure to direct sunlight or to the light of fluorescent lamps.

10.2.2 The LCD modules should be stored under the storage temperature range. If the LCD modules will be stored for a long time, the recommend condition is:

Temperature : 0°C ~ 40°C      Relatively humidity: ≤80%

10.2.3 The LCD modules should be stored in the room without acid, alkali and harmful gas.

### 10.3 Transportation Precautions

10.3.1 The LCD modules should be no falling and violent shocking during transportation, and also should avoid excessive press, water, damp and sunshine.