

MASTECH® MS8250D

DUAL DISPLAY DIGITAL MULTIMETER User's Manual

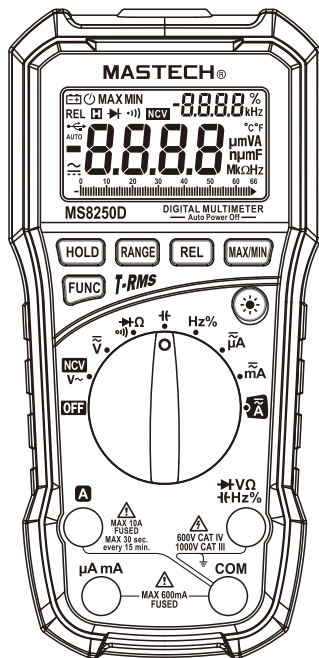

1. Safety Information



WARNING

Use caution and follow all safety guidelines to prevent electric shock or damage to the meter. Please read carefully all instructions before use.

Instrument meets GB/T 13978-92 concerning digital multimeter standards, along with GB4793.1-2007 (IEC61010-1, IEC61010-2-032) safety standards or electrical measuring instruments with an over-voltage category of CAT IV 600V, CAT III 1000V.

Follow all safety instructions to ensure safe use and long life of the instrument.







1.1 Preparation

- 1.1.1 When using the meter, follow all standard safety guidelines:
 - For universal protection against electric shock.
 - To prevent the misuse of the instrument.
- 1.1.2 Check the meter for damage during transit.
- 1.1.3 Test leads must be in good condition. Check the insulation and tips before use.
- 1.1.4 Safety can only be guaranteed with leads provided. If leads need to be replaced, they must be replaced with leads of same electrical specifications.

1.2 Using the Meter

- 1.2.1 Always set the meter to the proper function and range first.
- 1.2.2 Never exceed protection limits indicated for each measurement.
- 1.2.3 Keep fingers behind the probe barriers while measuring.
- 1.2.4 Always be careful when working with voltages above 60V DC or 30V AC RMS.
- 1.2.5 When using the CAT IV environment, if the measuring voltage between terminals and earth ground exceeds 600V, CAT III environments or voltage measurement between the terminal and the earth more than 1000V, do not measure voltage.
- 1.2.6 In manual range, if the circuit value is unknown, start the meter at the maximum range and then adjust accordingly.
- 1.2.7 Remove the leads from the circuit first before switching between functions.
- 1.2.8 Do not power on circuit while measuring resistance, capacitance, diodes and continuity.
- 1.2.9 Never connect the meter's leads across a voltage source while the rotary switch is in the resistance, capacitance, diode or continuity mode.
- 1.2.10 Do not measure capacitance before capacitors are discharged.
- 1.2.11 Do not operate the meter near explosive gas, vapor or dust.
- 1.2.12 Stop using the meter if any abnormality is observed.
- 1.2.13 Do not use the meter unless the battery cover is securely fastened to the meter.
- 1.2.14 Avoid direct exposure to sunlight to ensure extended life of the meter.

1.3 Safety Symbols

	Important safety information, please refer to user's manual.
	Caution when testing on live conductors.
	Double insulation protection (category II).
CAT IV	This meter has met IEC61010-1 standard with an overvoltage category (600V CAT IV) and pollution degree 2.
CAT III	Refers to the impulse withstand voltage protection level in accordance with IEC-61010-1 standard overvoltage (installation)category III,pollution degree 2.
	The meter complies with EU standard.
	Complies with U.S. and Canadian safety standards.
	Ground.

1.4 Maintenance

- 1.4.1 To avoid electric shock or personal injury, repairs/ servicing not covered in this manual should be performed only by qualified personnel.
- 1.4.2 Remove test leads from any circuit before opening battery cover.
- 1.4.3 To avoid false readings that may become dangerous, replace the battery as soon as the  symbol appears.
- 1.4.4 Clean the meter using a damp cloth and mild detergent only; do not use abrasives or chemical solvents.

- 1.4.5 Always move rotary switch to OFF when not using the meter.
- 1.4.6 If meter is not going to be used for an extended period of time, remove battery to prevent damage to the meter.

2. Description

- The MS8250D is a portable, hand-held yet professional meter that features True RMS measurement display, AC/DC current, AC/DC voltage, Frequency, Capacitance, Resistance, Continuity, Duty Ratio, Diode Testing and a USB adapter for recording readings on a PC. This Meter is easy to use even with one hand, suitable for professional users or amateurs, and ideal for school or home use.
- Both auto and manual range.
- Display hold
- True RMS for AC voltage/current measurements
- Relative measurement
- Maximum measurement
- Minimum measurement
- Display frequency when measuring AC voltage/current
- Automatic Power Off

2.1 Part Name

- (1) USB interface
- (2) NCV detection indicator
- (3) LCD display
- (4) Function buttons
- (5) Rotary switch
- (6) Input sockets
- (7) NCV detection sensor

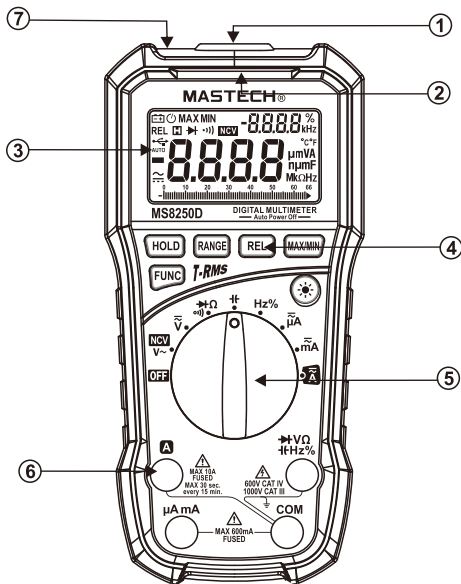

2.2 Buttons/Input jack description

HOLD: keep current reading on the display

FUNC: switch between functions or AC/DC measurement

RANGE: switch between auto/manual ranges

REL: display relative measurement

MAX/MIN: switch between max/min measurement display

☀: turn on/off backlight

OFF: Power off position

↔VΩ Hz%: input jack for voltage, resistance, capacitance, diode, continuity, frequency and duty cycle measurement

COM: common terminal

μA mA: μA and mA current input terminal

A: input jack for current measurement ($\leq 10A$)

2.3 LCD display

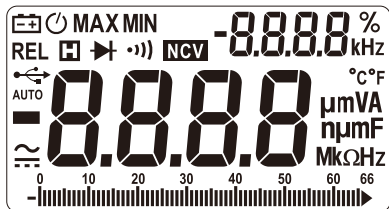

~	Alternating current
≡	Direct current
▶	Diode
o))	Continuity
AUTO	Auto range
MAX	Maximum display
MIN	Minimum display
⏻	Auto power off
⊖	Low battery
%	Percentage (duty cycle)
Hz, kHz	Hertz, kilohertz (frequency)
mV, V	Millivolts, volts (voltage)
μA, mA, A	Micro amps, milliamps, amps (current)
nF, μF, mF	Nanofarad, microfarad, millifarad (capacitance)
Ω, kΩ, MΩ	Ohms, kilaohms, megaohms
REL	Relative display
NCV	Non-contact voltage detection
USB	USB interface active

3. Specifications

Instrument should be calibrated annually at 18°C~28°C and relative humidity of <75%.

3.1 General Specifications

- 3.1.1 Auto and manual range
- 3.1.2 Full range overload protection
- 3.1.3 Max. voltage between terminal and ground:
 - CAT IV ,600V DC or AC rms.
 - CAT III ,1000V DC or AC rms
- 3.1.4 Operating altitude: 2000m max.
- 3.1.5 Display: LCD
- 3.1.6 Maximum display value:6599
- 3.1.7 Polarity indication: automatically displays “-”
- 3.1.8 Over range indication: “OL” or “-OL”
- 3.1.9 Sample rate: approx. 0.4s/analog bar graph: approx. 0.04s
except for current measurement: approx. 1s/bar graph: 0.1s
- 3.1.10 Unit display: functions and unit power
- 3.1.11 Auto power off time: approx. 15 minutes.
- 3.1.12 Power supply: 9V battery
- 3.1.13 Low battery indication: display shows “⊖”
- 3.1.14 Temp. coefficient: less than 0.1 x accuracy/°C
- 3.1.15 Operating temperature: 0~40°C
- 3.1.16 Storage temperature: -10~50°C
- 3.1.17 Dimensions: 180x86x52mm
- 3.1.18 Weight: approx. 250g (without battery)

3.2 Technical Indicators

3.2.1 True RMS characteristics

- 3.2.1.1 For non-sinusoidal signal measurement, the Meter provides more accurate measurement than the traditional averaging method.
- 3.2.1.2 If in AC current mode, the Meter may display a random reading between 1 and 50 when the input is not active. This will not affect the accuracy of measurement.
- 3.2.1.3 True RMS requires a minimum input level, AC current or voltage should be 2%~100% of the maximum level.

3.2.2 DC Voltage

Range	Resolution	Accuracy
660mV	0.1mV	±(0.8% of reading + 3 digits)
6.6V	0.001V	±(0.5% of reading + 5 digits)
66V	0.01V	
660V	0.1V	
1000V	1V	

- Input impedance: 10MΩ
- Overload protection: 660mV range: 250V DC or AC rms. 6.6V-1000V ranges: 1000V DC or 1000V AC rms.
- Max. input voltage: 1000V DC

3.2.3 AC Voltage

Range	Resolution	Accuracy
660mV	0.1mV	±(1.5% reading + 5 digits)
6.6V	0.001V	±(1.2% reading + 5 digits)
66V	0.01V	
660V	0.1V	±(1.0% reading + 3 digits)
1000V	1V	

- Input impedance: 10MΩ
- Overload protection: 660mV range: 250V DC or AC rms. 6.6V-1000V ranges: 1000V DC or 1000V AC rms.
- Max. input voltage: 1000V AC
- Frequency response: 50 ~ 60Hz
- Response: True RMS

3.2.4 Resistance

Range	Resolution	Accuracy
660Ω	0.1Ω	±(0.8% reading + 5 digits)
6.6kΩ	0.001kΩ	
66kΩ	0.01kΩ	
660kΩ	0.1kΩ	
6.6MΩ	0.001MΩ	
66MΩ	0.01MΩ	±(1.5% reading + 5 digits)

- Open circuit voltage: approx. 1.0V
- Overload protection: 250V DC or AC rms.

3.2.5 Capacitance

Range	Resolution	Accuracy
6.6nF	0.001nF	±(4.0% reading + 5 digits)
66nF	0.01nF	
660nF	0.1nF	
6.6μF	0.001μF	±(3.0% reading + 3 digits)
66μF	0.01μF	
660μF	0.1μF	
6.6mF	0.001mF	±(4.0% reading + 5 digits)
66mF	0.01mF	

- Overload protection: 250V DC or AC (RMS)

3.2.6 Diode Test

Range	Resolution	Function
	0.001V	Display approximate diode forward voltage value

- Forward DC current: approx. 1mA
- Reverse DC voltage: approx. 3.2V
- Overload protection: 250V DC or AC rms.

3.2.7 Circuit Continuity Test

Range	Resolution	Function
	0.1Ω	If the resistance of circuit to be measured is less than 50Ω, the meter's built-in buzzer will sound.

- Open circuit voltage is about 1.0V
- Overload protection: 250V DC or AC (RMS)

3.2.8 Frequency

3.2.8.1 In V mode:

Range	Resolution	Accuracy
66Hz	0.01Hz	±(1.5% reading + 5 digits)
660Hz	0.1Hz	
6.6kHz	0.001kHz	
10kHz	0.01kHz	

- Frequency range: 10Hz~10kHz
- Input voltage range: ≥0.2V AC(rms)(as measured frequency increases, voltage will also increase)

3.2.8.2 Pass Hz grade:

Range	Resolution	Accuracy
66Hz	0.01Hz	±(1.5% reading + 5 digits)
660Hz	0.1Hz	
6.6kHz	0.001kHz	
66kHz	0.01kHz	
660kHz	0.1kHz	
6.6MHz	1kHz	
66MHz	10kHz	

- Overload protection: 250V DC or AC rms.
- Measurement signal: Vpp=3V AC

3.2.8.3 Duty Ratio

Range	Resolution	Accuracy
1-99%	0.1%	±2.0%

3.2.9 DC Current

Range	Resolution	Accuracy
660μA	0.1μA	±(1.0% reading + 5 digits)
6600μA	1μA	
66mA	10μA	
660mA	100μA	
10A	10mA	±(2.0% reading + 5 digits)

- Overload protection:

μA/mA jack: FF 600mA/1000V. A jack: FF 10A/1000V.

- When measuring current larger than 5A, do not continue measurement for greater than 10s. Wait 1 min. after measurement before resuming.

3.2.10 AC Current

Range	Resolution	Accuracy
660μA	0.1μA	±(1.5% reading + 5 digits)
6600μA	1μA	
66mA	10μA	
660mA	100μA	
10A	10mA	±(3.0% reading + 5 digits)

- Overload protection:

μA/mA jack: FF 600mA/1000V. A jack: FF 10A/1000V.

- Frequency response: 50 ~ 60Hz

- Response: True RMS

- When measuring current larger than 5A, do not continue measurement for greater than 10s. Wait 1 min. after measurement before resuming.

4. Using the Meter

4.1 Data Hold

4.1.1 During measurement, if you want to keep the reading on the display, press "**HOLD**" and the reading will be held.

4.1.2 Press "**HOLD**" again to release the hold.

4.2 Manual Range

4.2.1 In voltage, current, resistance, capacitance, and frequency modes, the default range is auto.

4.2.2 Press "**RANGE**" to switch to manual range. Each press of the button increases the range, and returns to the lowest range when pressed in the largest range.

4.2.3 Hold down "**RANGE**" for 1 second to return to auto range.

4.2.4 When in Max/Min modes, pressing "**RANGE**" to return to normal measurement.

Note:

Frequency cannot be set to manual range.

4.3 Relative Mode

4.3.1 Press "**REL**" to enter relative mode. The meter stores the measured value when the button was pressed and compares it to the currently measured value (rel = current reading - stored reading).

4.4 Maximum/Minimum Mode

4.4.1 Press "**MAX/MIN**" in any range to show the maximum value recorded; press "**MAX/MIN**" again to show the minimum value recorded; press "**MAX/MIN**" a third time to return the display to normal.

4.5 Function Switch

- 4.5.1 In voltage and current modes, press "FUNC" to switch between AC and DC modes.
- 4.5.2 In the multi-function position, press "FUNC" to switch between resistance, diode and continuity modes.

4.6 Backlight

- 4.6.1 Press "☀" key, turn on or off backlight.

4.7 Auto Power Off

- 4.7.1 If the meter is not used for 15 minutes, the meter will automatically turn itself off to save battery power.
- 4.7.2 To turn the meter back on, press any button.
- 4.7.3 Holding "FUNC" when turning on the meter will disable auto power off.

4.8 USB Communication

- 4.8.1 Install the included software and USB driver (See PC CD-ROM software user's guide) on a PC.
- 4.8.2 Use the included USB cable to connect the meter to the PC; the  symbol appears on the display.
- 4.8.3 Open the installed software and the meter will begin sending the measured data to the software.

4.9 NCV (Non-Contact Voltage detection)

- 4.9.1 Move the rotary switch to the NCV position.
- 4.9.2 Move the NCV sensor (top of the meter) toward the object to be tested. If the sensor detects voltage greater than 110VAC (rms), the NCV indicator will flash and the meter will beep.

Note:

1. Even without indication, voltage may still exist. Do not solely rely on NCV detection to determine in voltage exists. Detection may be affected by socket design, insulation thickness or other factors.
2. NCV indicator may go off when measuring voltage due to the presence of induced voltage.
3. Interference sources may accidentally trigger NCV detector.

4.10 DC/AC Voltage

Voltage is the potential difference between two points. The polarity of AC voltage changes over time where DC voltage polarity does not.

DC voltage ranges: 660.0mV, 6.600V, 66.00V, 660.0V, 1000V .AC voltage ranges: 660mV, 6.600V, 66.00V, 660.0V, 1000V. 660.0mV range can only be entered through manual range.

Measuring DC/AC voltage:

- 4.10.1 Move the rotary switch to the $\approx V$ position.
- 4.10.2 Connect the red test lead to the V jack and the black lead to the COM jack.
- 4.10.3 Connect the leads in parallel with the circuit under test.
- 4.10.4 The measured voltage will be displayed. For DC measurement, the polarity of the red lead will be indicated.
- 4.10.5 Press "FUNC" to switch between DC and AC voltage.

4.11 Resistance

Resistance ranges: 660.0 Ω , 6.600k Ω , 66.00k Ω , 660.0k Ω , 6.600M Ω , 66.00M Ω .

To measure resistance:

- 4.11.1 Move rotary switch to the  position.
- 4.11.2 Connect the red test lead to the Ω jack and the black lead to the COM jack.
- 4.11.3 Connect leads to circuit under test.
- 4.11.4 The measured resistance will be displayed.

4.12 Continuity

While in resistance mode, press “FUNC” to switch to continuity mode.

- 4.12.1 Connect the red test lead to the Ω jack and the black lead to the COM jack
- 4.12.2 Connect leads to circuit under test.
- 4.12.3 If the measured resistance is less than 50 Ω , the meter’s buzzer will sound.

4.13 Diode Test



While in continuity mode, press “FUNC” to switch to diode mode.

- 4.13.1 Connect the red test lead to the V jack and the black lead to the COM jack.
- 4.13.2 Connect leads across the diode under test.
- 4.13.3 The display shows the approx. forward voltage drop.

4.14 Capacitance

Capacitance ranges: 6.600nF, 66.00nF, 660.0nF, 6.600 μ F, 66.00 μ F, 660.0 μ F, 6.600mF and 66.00mF.

Measuring capacitance:

- 4.14.1 Move the rotary switch to the  position.
- 4.14.2 Connect the red test lead to the  jack and the black lead to the COM jack.
- 4.14.3 Connect the leads across the capacitor for measurement
- 4.14.4 The measured capacitance will be displayed

4.15 Frequency and Duty Cycle

Frequency ranges: 66.00Hz, 660.0Hz, 6.600kHz, 66.00kHz, 660.0kHz, 6.600MHzV, 66.00MHz.

Measuring Frequency:

- 4.15.1 Move the rotary switch to the Hz% position.
- 4.15.2 Connect the red test lead to the Hz% jack and the black lead to the COM jack.
- 4.15.3 Connect the leads across the circuit under test.
- 4.15.4 The measured frequency will be displayed.
- 4.15.5 Press “FUNC” to switch to duty cycle.
- 4.15.6 Repeat steps 2-4 to measure duty cycle.

4.16 DC/AC Current

Current ranges: 660.0 μ A, 6600 μ A, 66.00mA, 660.0mA, 10.00A.

- 4.16.1 Turn off power to the circuit and discharge all capacitors fully.
- 4.16.2 Move the rotary switch to the appropriate current position (μ A, mA, or A)
- 4.16.3 Connect the black test lead to the COM jack. If the current to be measured is less than 600mA, connect the red test lead to the μ mA jack. If the current to be measured is between 600mA and 10A, connect the red test lead to the A jack.

- 4.16.4 Connect the leads in series to the circuit under test (break circuit and connect red lead to the relatively higher voltage side and black lead to relatively lower voltage side).
- 4.16.5 Turn power back on to circuit and the measured current will be displayed. If the display shows “OL”, it means the current exceeds the selected range; move the rotary switch to the next highest range.

5. Maintenance

5.1 Replacing the Battery



WARNING
Remove test leads from any circuit before opening battery cover to avoid electric shock injury.

- 5.1.1 If the “” symbol appears, it indicated the battery needs to be replaced.
- 5.1.2 Loosen the screw and remove battery cover.
- 5.1.3 Replace the used battery with a new one.
- 5.1.4 Replace the battery cover and tighten screw.

Note:

Pay attention to the polarity of the battery to avoid damage to the meter.

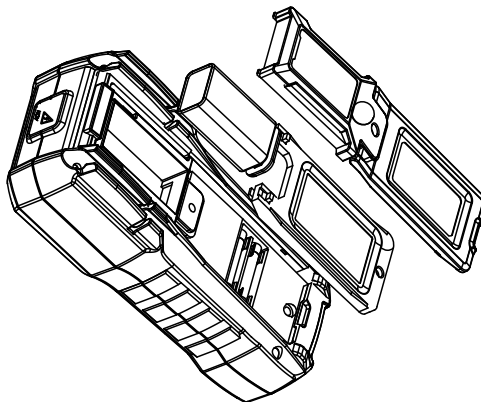

5.2 Replace Probe



WARNING
If leads need to be replaced, they must be replaced with ones that are of the same electrical specifications.: 1000V, 10A

If insulation on leads is damaged, replace test leads.

6. Accessories

1)	Test leads		1Pair
2)	Manual		1pcs
3)	Battery	9V 6F22	1pcs
4)	USB interface cable		1pcs
5)	USB interface software	CD ROM disc	1pcs

