

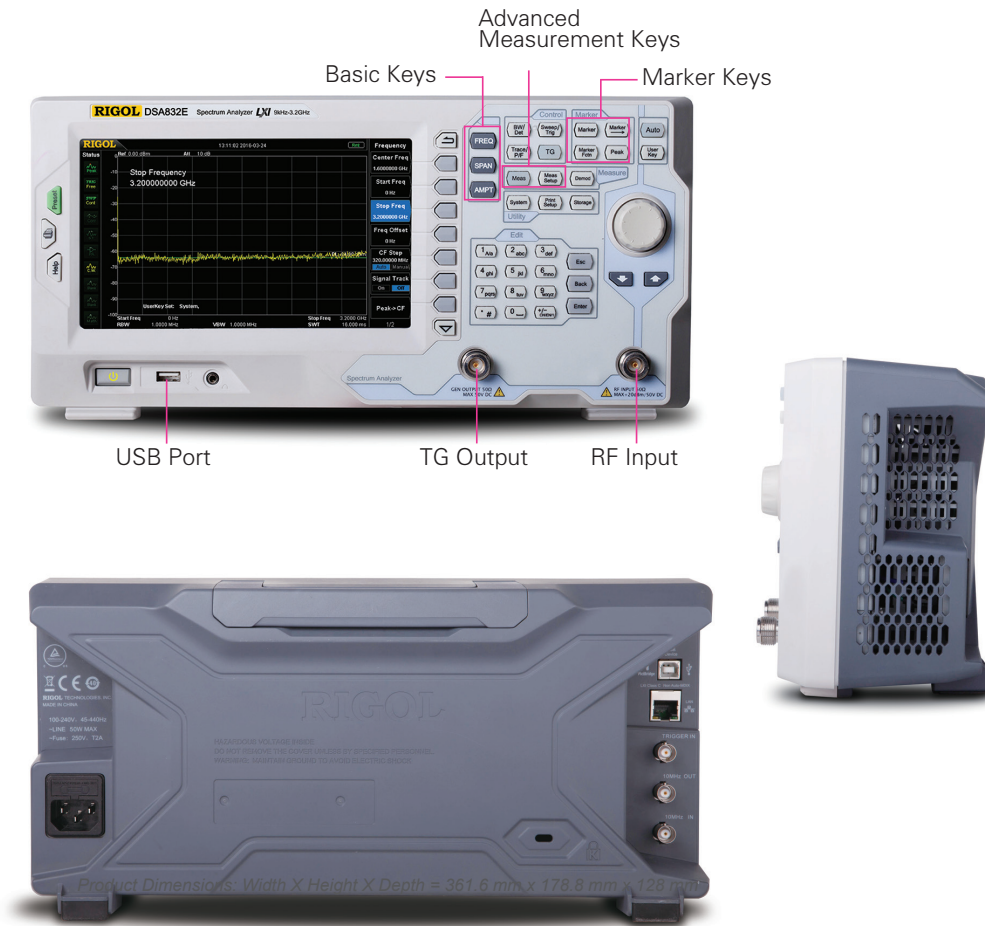

DSA800E Series Spectrum Analyzer

- All-Digital IF Technology
- Frequency Range from 9 kHz to 3.2 GHz
- Min. -148 dBm Displayed Average Noise Level (Typ.)
- Min. <-90 dBc/Hz @ 10 kHz Offset Phase Noise
- Level Measurement Uncertainty <1.0 dB
- 10 Hz Minimum Resolution Bandwidth
- Up to 3.2 GHz Tracking Generator (DSA832E-TG)
- Optional Preamplifier
- Advanced Measurement Functions (Opt.)
- EMI Filter & Quasi-Peak Detector Kit (Opt.)
- VSWR Measurement Kit (Opt.)
- PC Software (Opt.)
- Optional RF TX/RX Training Kit
- Optional RF Accessories (Cable, Adaptor, Attenuator, Bridge ...)
- Complete Connectivity: LAN (LXI), USB Host & Device, GPIB (Opt.)
- 8 Inch WVGA (800×480) Display
- Compact Size, Light Weight Design

DSA800E Series Spectrum Analyzer



Product Dimensions: Width × Height × Depth = 361.6 mm × 178.8 mm × 128 mm

► Benefits of Rigol's all digital IF design

- The ability to measure smaller signals: on the basis of this technology, the IF filter enables smaller bandwidth settings, which greatly reduce the displayed average noise level.
- The ability to distinguish between small signals by frequency: using the IF filter with the smallest bandwidth setting, it is possible to make out signals with a frequency difference of only 10 Hz.
- High precision amplitude readings: this technology almost eliminates the errors generated by filter switching, reference level uncertainty, scale distortion, as well as errors produced in the process of switching between logarithmic and linear display of amplitude when using a traditional analog IF design.
- Higher reliability: compared with traditional analog designs, the digital IF greatly reduces the complexity of the hardware, the system instability caused by channel aging, and the temperature sensitivity that can contribute to parts failure.
- High measurement speed: the use of digital IF technology improves the bandwidth precision and selectivity of the filter, minimizing the scanning time and improving the speed of the measurement.

► Features and Benefits

Distinguish the two nearby signals clearly with the 10 Hz RBW

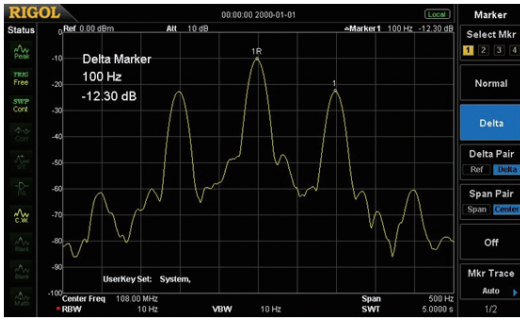

Compare the spectrums with different color trace

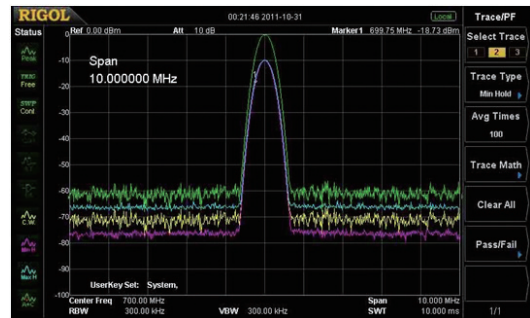

Readout the spectrum peak values with the peak table function

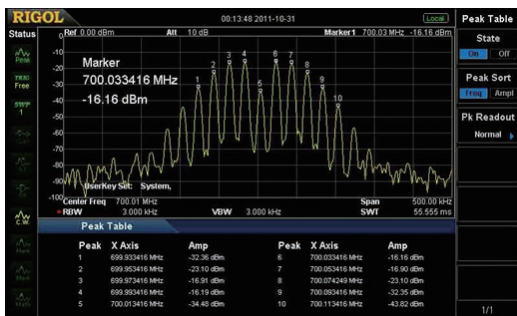

Measure lower level signal with the preamplifier turn on

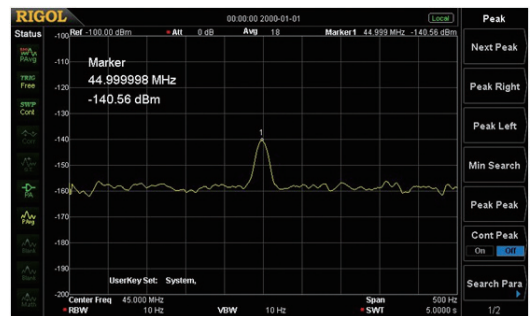

Phase noise < -90 dBc/Hz @10 kHz offset

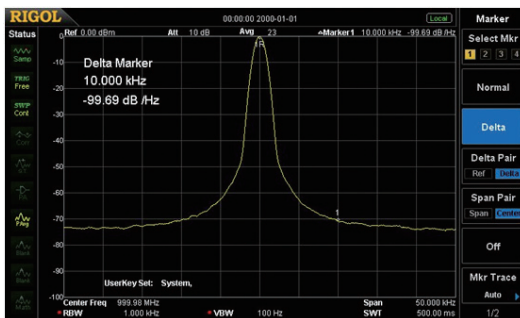

EMI kit (EMI filter & Quasi-peak & Pass/Fail)

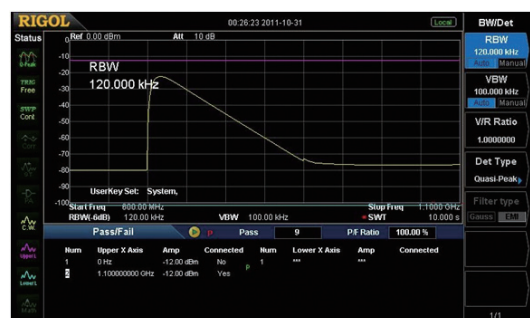

The GUI to control the RF demo kit (Transmitter) directly

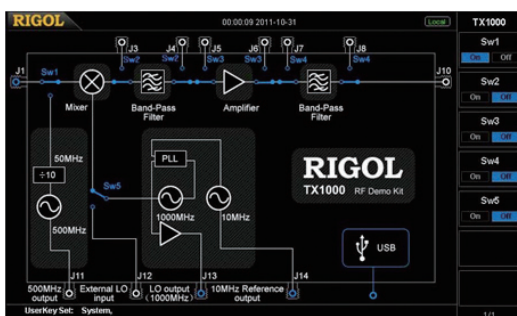

VSWR measurement

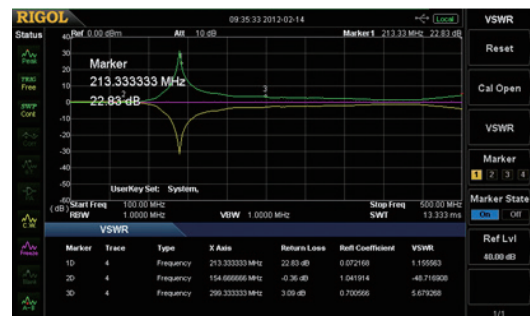

► RIGOL Spectrum Analyzer Option and Accessory

| | | |
|------------------------|------------------------|--------------------|
| Harmonic Distortion | TOI | Emission Bandwidth |
| Channel Power | Occupied Bandwidth | |
| Time Domain Power | Carrier to Noise Ratio | |
| Adjacent Channel Power | Pass/Fail | |

Advanced Measurement Kit
(AMK-DSA800)

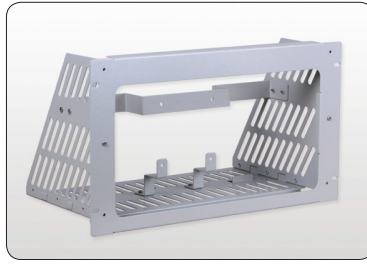

Rack Mount Kit
(RM-DSA800)

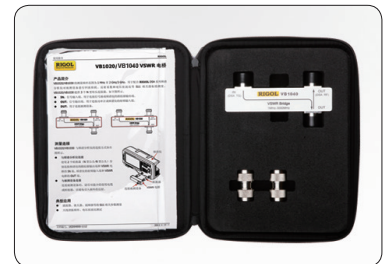

VSWR Bridge
(VB1020/VB1032/VB1040/VB1080)

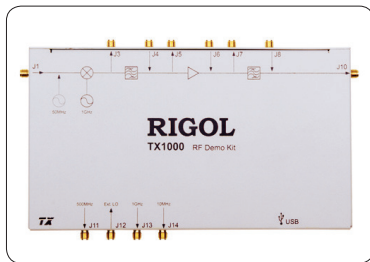

RF Demo Kit
(TX1000)

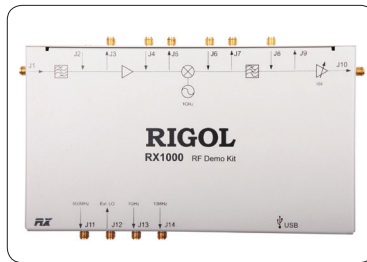

RF Demo Kit
(RX1000)



RF CATV Kit



DSA Utility Kit



RF Adaptor Kit



RF Attenuator Kit



RF Cable Kit
(CB-NM-NM-75-L-12G)
(CB-NM-SMAM-75-L-12G)



High Power Attenuator
(ATT03301H)

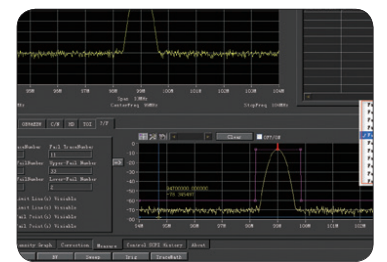

DSA PC Software
(Ultra Spectrum)



USB to GPIB Converter
(USB-GPIB)

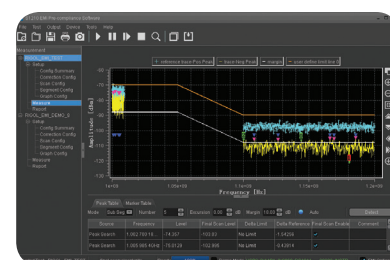

EMI Pre-compliance Test Software
(S1210 EMI Pre-compliance Software)



Near Field Probe
(NFP-3)

► Specifications

Specifications are valid under the following conditions: the instrument is within the calibration period, is stored for at least two hours at 0 °C to 50 °C temperature, and is warmed up for 40 minutes. Unless otherwise noted, the specifications in this manual include the measurement uncertainty.

Typical (typ.): characteristic performance, which 80 percent of the measurement results will meet at room temperature (approximately 25°C). This data is not warranted and does not include the measurement uncertainty.

Nominal (nom.): the expected mean or average performance or a designed attribute (such as the 50Ω connector). This data is not warranted and is measured at room temperature (approximately 25°C).

Measured (meas.): an attribute measured during the design phase which can be compared to the expected performance, such as the amplitude drift variation with time. This data is not warranted and is measured at room temperature (approximately 25°C).

NOTE: All charts in this manual are the measurement results of multiple instruments at room temperature unless otherwise noted. The specifications (except the TG specifications) listed in this manual are those when the tracking generator is off.

Frequency

| Frequency | |
|----------------------|------------------|
| | DSA832E |
| Frequency range | 9 kHz to 3.2 GHz |
| Frequency resolution | 1 Hz |

| Internal Reference Frequency | |
|------------------------------|---|
| Reference frequency | 10 MHz |
| Accuracy | $\pm[(\text{time since last calibration} \times \text{aging rate}) + \text{temperature stability} + \text{calibration accuracy}]$ |
| Initial calibration accuracy | <1 ppm |
| Temperature stability | 0°C to 50°C , reference to 25°C |
| | <1 ppm |
| Aging rate | <2 ppm/year |

| Frequency Readout Accuracy | |
|----------------------------|---|
| Marker resolution | span/ (number of sweep points - 1) |
| Marker uncertainty | $\pm(\text{frequency indication} \times \text{reference frequency accuracy} + 1\% \times \text{span} + 10\% \times \text{resolution bandwidth} + \text{marker resolution})$ |

| Frequency Counter | |
|-------------------|---|
| Resolution | 1 Hz, 10 Hz, 100 Hz, 1 kHz, 10 kHz, 100 kHz |
| Uncertainty | $\pm(\text{frequency indication} \times \text{reference frequency accuracy} + \text{counter resolution})$ |

| Frequency Span | |
|----------------|---|
| Range | 0 Hz, 100 Hz to maximum frequency of instrument |
| Uncertainty | $\pm\text{span}/ (\text{number of sweep points} - 1)$ |

| SSB Phase Noise | | |
|-----------------|--------------------------------------|-------------|
| | 20°C to 30°C , $f_c = 1 \text{ GHz}$ | |
| Carrier offset | 10 kHz offset | <-90 dBc/Hz |

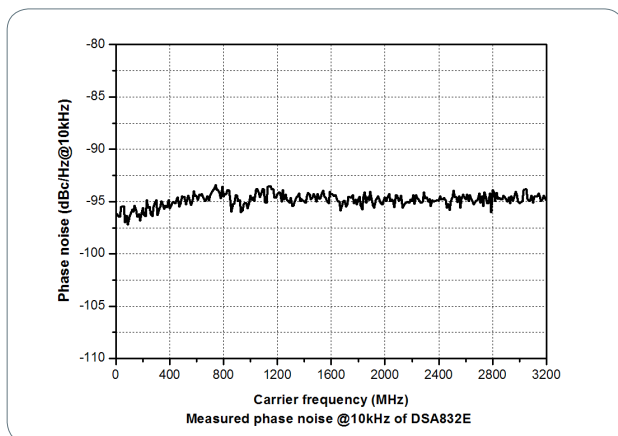

| | |
|--|------------------------------------|
| Residual FM | |
| | 20°C to 30°C , RBW = VBW = 1 kHz |
| Residual FM | <20 Hz (nom.) |
| Bandwidths | |
| | Set "Auto SWT" to "Accy" |
| Resolution bandwidth (-3 dB) | 10 Hz to 1 MHz, in 1-3-10 sequence |
| RBW uncertainty | <5% (nom.) |
| Resolution filter shape factor (60 dB : 3 dB) | <5 (nom.) |
| Video bandwidth (-3 dB) | 1 Hz to 3 MHz, in 1-3-10 sequence |
| Resolution bandwidth (-6 dB) (EMI-DSA800 option) | 200 Hz, 9 kHz, 120 kHz |

Amplitude

| | |
|----------------------------------|---|
| Measurement Range | |
| Range | $f_c \geq 10$ MHz DANL to +20 dBm |
| Maximum Input Level | |
| DC voltage | 50 V |
| CW RF power | attenuation = 30 dB +20 dBm (100 mW) |
| Max. damage level ^[1] | +30 dBm (1 W) |

NOTE: [1] When $f_c \geq 10$ MHz, input level > +25 dBm and PA is Off, the protection switch will be on.

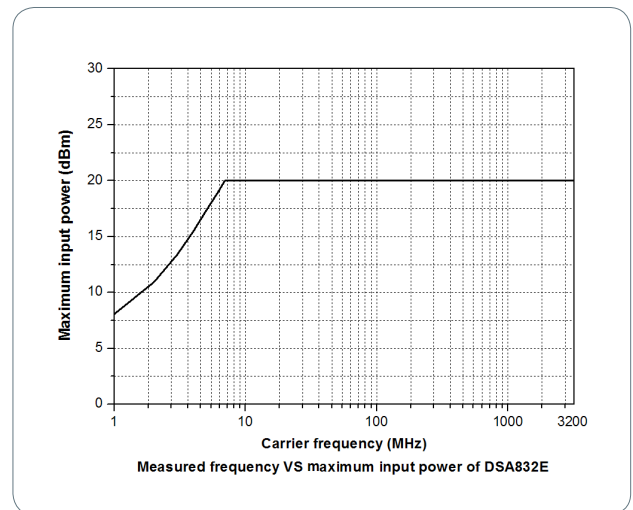
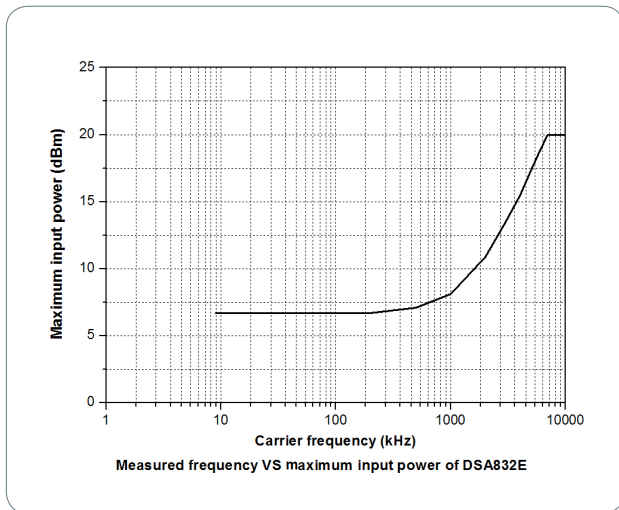

| | | |
|--------------------------------------|------------------|--|
| Displayed Average Noise Level (DANL) | | attenuation = 0 dB, RBW = VBW = 10 Hz, sample detector, trace average ≥ 50 , tracking generator off, 20°C to 30°C , input impedance = 50 Ω |
| PA off | 9 kHz to 100 kHz | <-110 dBm (typ.) |
| | 100 kHz to 5 MHz | <-122 dBm, <-125 dBm (typ.) |
| | 5 MHz to 3.2 GHz | <-127 dBm, <-130 dBm (typ.) |
| PA on | 100 kHz to 1 MHz | <-142 dBm (typ.) |
| | 1 MHz to 5 MHz | <-140 dBm, <-143 dBm (typ.) |
| | 5 MHz to 3.2 GHz | <-145 dBm, <-148 dBm (typ.) |

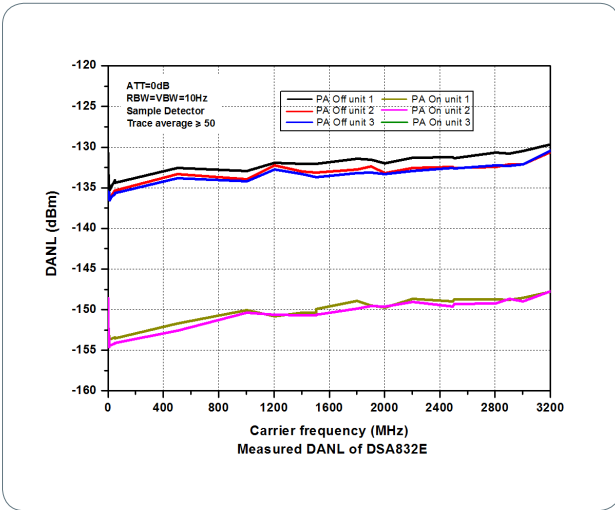

| Level Display | |
|--------------------------|---|
| Logarithmic level axis | 1 dB to 200 dB |
| Linear level axis | 0 to reference level |
| Number of display points | 601 |
| Number of traces | 3 + math trace |
| Trace detectors | normal, positive-peak, negative-peak, sample, RMS, voltage average quasi-peak (with EMI-DSA800 option) |
| Trace functions | clear write, max hold, min hold, average, view, blank |
| Units of level axis | dBm, dBmV, dBμV, nV, μV, mV, V, nW, μW, mW, W |

| Frequency Response | |
|--------------------|---|
| | $f_c \geq 100$ kHz, attenuation = 10 dB, relative to 50 MHz, 20°C to 30°C |
| PA off | 100 kHz to 3.2 GHz <0.7 dB |
| | $f_c \geq 1$ MHz, attenuation = 10 dB, relative to 50 MHz, 20°C to 30°C |
| PA on | 100 kHz to 3.2 GHz <1.0 dB |

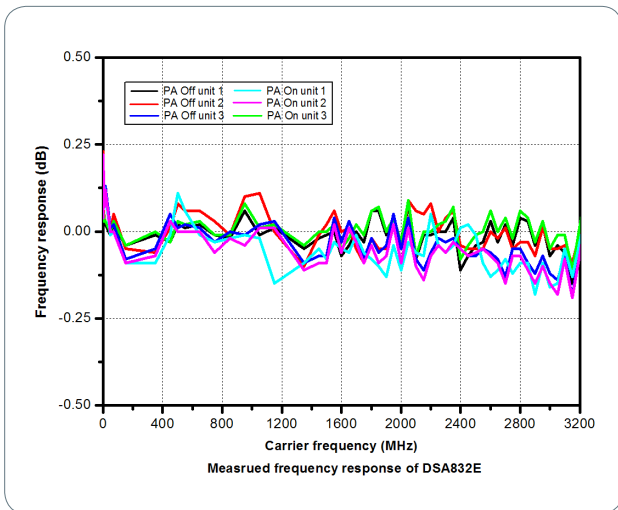

| Input Attenuation Switching Uncertainty | |
|---|--|
| Setting range | 0 dB to 30 dB, in 1 dB step |
| Switching uncertainty | $f_c = 50$ MHz, relative to 10 dB, 20°C to 30°C <0.3 dB |

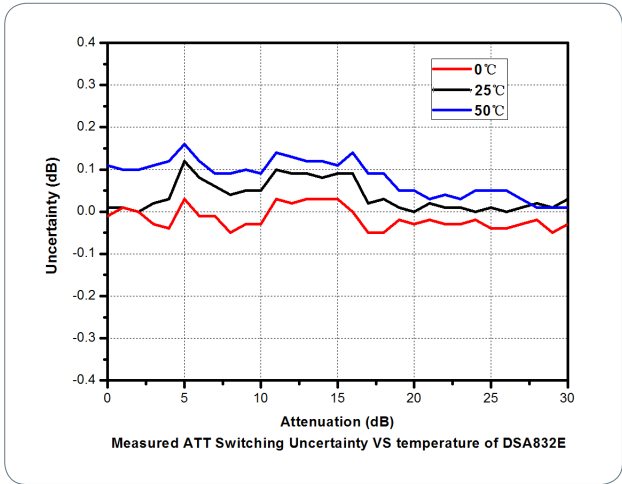

Absolute Amplitude Uncertainty

| | |
|-------------|---|
| Uncertainty | $f_c = 50$ MHz, peak detector, preamplifier off, attenuation = 10 dB, input signal level = -10dBm, 20°C to 30°C |
| | <0.3 dB |

RBW Switching Uncertainty

| | |
|-------------|-----------------------|
| Uncertainty | relative to 1 kHz RBW |
| | <0.1 dB |

Reference Level

| | | |
|------------|-----------------------------------|----------|
| Range | -100 dBm to +20 dBm, in 1 dB step | |
| Resolution | log scale | 0.01 dB |
| | linear scale | 4 digits |

Preamplifier

| | | |
|------|--------------------|--------------|
| | PA-DSA832 (option) | |
| Gain | 100 kHz to 3.2 GHz | 17 dB (nom.) |

Level Measurement Uncertainty

| | | |
|-------------------------------|--|--|
| | 95% confidence level, S/N > 20 dB, RBW = VBW = 1 kHz, preamplifier off, attenuation = 10 dB, -50 dBm < input level ≤ 0 dBm, $f_c > 10$ MHz, 20°C to 30°C | |
| Level measurement uncertainty | <1.0 dB (nom.) | |

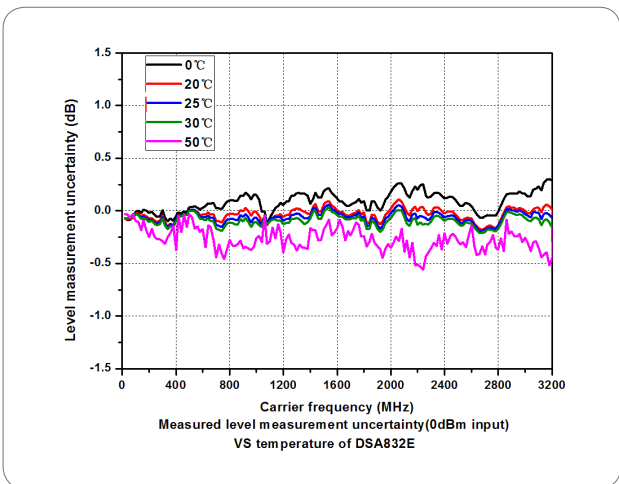

RF Input VSWR

| | | |
|------|--------------------------|-------------|
| | attenuation ≥ 10 dB | |
| VSWR | 300 kHz to 3.2 GHz | <1.5 (nom.) |

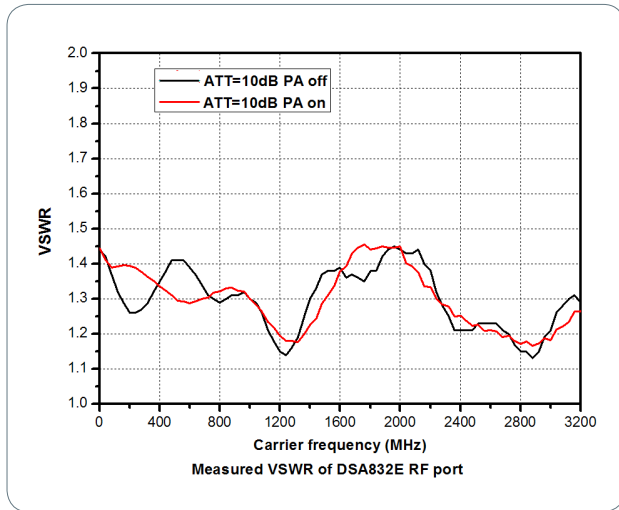

Distortion

| | | |
|--|--|---------|
| Second Harmonic Intercept | | |
| Second harmonic intercept (SHI) | $f_c \geq 50$ MHz, input signal level = -20 dBm, attenuation = 10 dB | +40 dBm |
| Third-order Intercept | | |
| Third-order intercept (TOI) | $f_c \geq 50$ MHz, two -20 dBm tones at input mixer spaced by 200 kHz, attenuation = 10 dB | +7 dBm |
| 1dB Gain Compression | | |
| 1dB compression of input mixer (P_{1dB}) | $f_c \geq 50$ MHz, attenuation = 0 dB | >0 dBm |

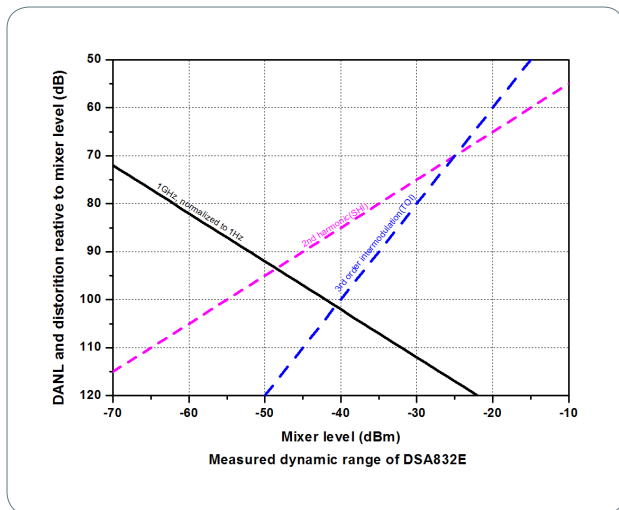

| Spurious Response | |
|-----------------------------|--|
| Spurious response, inherent | input terminated 50 Ω , attenuation = 0 dB, 20°C to 30°C <-90 dBm ^[2] , <-100 dBm (typ.) |
| Intermediate frequency | <-60 dBc |
| System related sidebands | referenced to local oscillators, referenced to A/D conversion, referenced to subharmonic of first LO, referenced to harmonic of first LO <-60 dBc |
| Input related spurious | mixer level = -30dBm <-60 dBc |

NOTE: [2] Except the internal local oscillator (1820 MHz) and its harmonics.

Sweep

| Sweep | | |
|------------------------|---|----------------------|
| Sweep time | span \geq 100 Hz | 1 ms to 3200 s |
| | zero span | 20 μ s to 3200 s |
| Sweep time uncertainty | span \geq 100 Hz | 5% (nom.) |
| | zero span (sweep time setting value > 1 ms) | 5% (nom.) |
| Sweep mode | | continuous, single |

Tracking Generator (Option)

| TG Output | |
|-------------------------|---|
| Frequency range | 100 kHz to 3.2 GHz |
| Output level range | -40 dBm to 0 dBm |
| Output level resolution | 1 dB |
| Output flatness | relative to 50 MHz \pm 3 dB (nom.) |

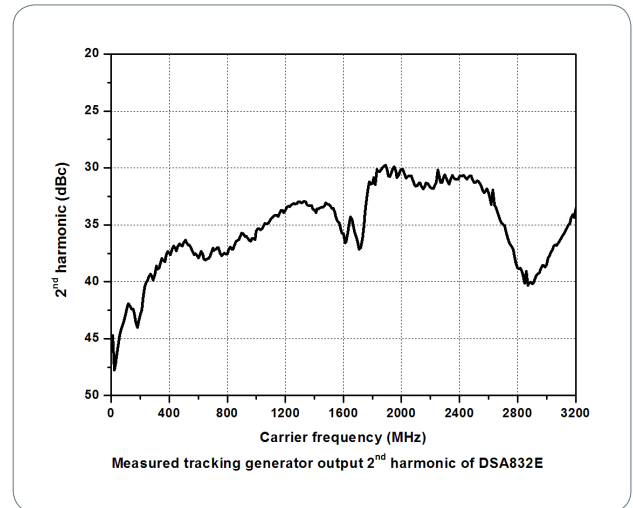
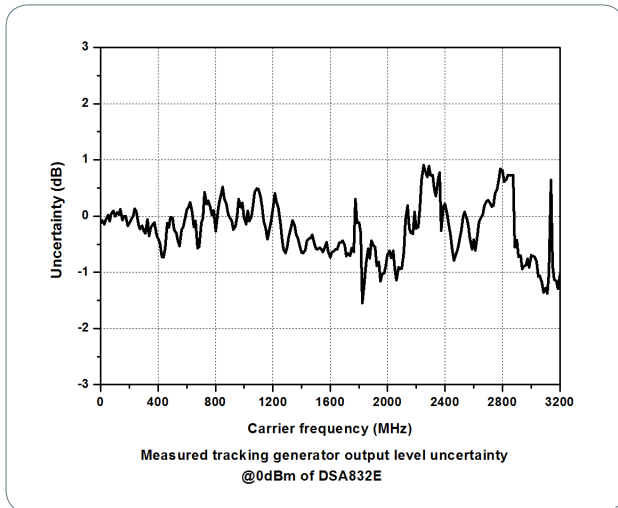

Trigger

| Trigger | |
|------------------------|------------------------|
| Trigger source | Trigger source |
| External trigger level | External trigger level |

Input /Output

| Front Panel Connectors | | |
|---------------------------|-----------|--------------------|
| RF input | impedance | 50 Ω (nom.) |
| | connector | N female |
| Tracking generator output | impedance | 50 Ω (nom.) |
| | connector | N female |

| Internal/ External Reference | | |
|------------------------------|--------------|----------------------------------|
| Internal reference | frequency | 10 MHz |
| | output level | +3 dBm to +10 dBm, +8 dBm (typ.) |
| | impedance | 50 Ω (nom.) |
| External reference | connector | BNC female |
| | frequency | 10 MHz \pm 5 ppm |
| | input level | 0 dBm to +10 dBm |
| | impedance | 50 Ω (nom.) |
| | connector | BNC female |

| External Trigger Input | | |
|------------------------|-----------|---------------------|
| External trigger input | impedance | 1 k Ω (nom.) |
| | connector | BNC female |

| Communication Interface | | |
|---------------------------------------|----------------------|-------------------|
| USB host | connector | A plug |
| | protocol | version2.0 |
| USB device | connector | B plug |
| | protocol | version2.0 |
| LAN | LXI core 2011 device | 10/100Base, RJ-45 |
| IEC/IEEE (GPIB) bus (USB-GPIB option) | | IEEE488.2 |

General Specifications

| Display | |
|------------|------------------|
| Type | TFT LCD |
| Resolution | 800 x 480 pixels |
| Size | 8 inch |
| Colors | 64k |

| Printer Supported | |
|-------------------|------------|
| Protocol | PictBridge |

| Mass Memory | |
|-------------|---|
| Mass memory | flash disk (internal), USB storage device (not supplied) |

| Power Supply | |
|-------------------------|---|
| Input voltage range, AC | 100 V to 240 V (nom.) |
| AC supply frequency | 45 Hz to 440 Hz |
| Power consumption | 35 W (typ.), max. 50 W with all options |

| Environmental | | |
|---------------|-----------------------------|--------------------------|
| Temperature | operating temperature range | 0°C to 50°C |
| | storage temperature range | -20°C to 70°C |
| Humidity | 0°C to 30°C | \leq 95% rel. humidity |
| | 30°C to 40°C | \leq 75% rel. humidity |
| Altitude | operating height | up to 3,000m |

| Electromagnetic Compatibility and Safety | | |
|--|--|--|
| EMC | in line with EN61326-1:2006 | |
| | IEC 61000-4-2:2001 | \pm 4.0 kV (contact discharge), \pm 4.0 kV (air discharge) |
| | IEC 61000-4-3:2002 | 3 V/m (80 MHz to 1 GHz), 3 V/m (1.4 GHz to 2 GHz), 1 V/m (2.0 GHz to 2.7 GHz) |
| | IEC 61000-4-4:2004 | 1 kV power lines |
| | IEC 61000-4-5:2001 | 0.5 kV (phase to neutral), 0.5 kV (phase to PE), 1 kV (neutral to PE) |
| | IEC 61000-4-6:2003 | 3 V, 0.15 to 80 MHz |
| | IEC 61000-4-11:2004 | voltage dip: 0% UT during half cycle, 0% UT during 1 cycle, 70% UT during 25 cycles short interruption: 0% UT during 250 cycles |
| Electrical safety | in line with UL 61010-1:2012, CAN/CSA-C22.2 No. 61010-1-12, EN 61010-1:2010 | |

| Dimensions | |
|-------------|---|
| (W x H x D) | 361.6 mm × 178.8 mm × 128 mm (14.2 in × 7.0 in × 5.0 in) |

| Weight | |
|-------------------------|-------------------|
| Standard | 4.55 kg (10.0 lb) |
| With tracking generator | 5.15 kg (11.4 lb) |

| Calibration Interval | |
|----------------------------------|--------|
| Recommended calibration interval | 1 year |

► Ordering Information

| | Description | Order Number |
|----------------------|---|-----------------------------------|
| Model | spectrum analyzer, 9 kHz to 3.2 GHz | DSA832E |
| | spectrum analyzer, 9 kHz to 3.2 GHz (with tracking generator, factory installed) | DSA832E-TG |
| Standard accessories | quick guide (hard copy) | - |
| | power cable | - |
| Options | preamplifier, 100 kHz to 3.2 GHz | PA-DSA832 |
| | EMI filter & quasi-peak detector | EMI-DSA800 |
| | advanced measurement kit | AMK-DSA800 |
| | VSWR measurement kit | VSWR-DSA800 |
| | DSA PC software | Ultra Spectrum |
| Optional accessories | include: N-SMA cable, BNC-BNC cable, N-BNC adaptor, N-SMA adaptor, 75 Ω to 50 Ω adaptor, 900 MHz/1.8 GHz antenna (2pcs), 2.4 GHz antenna (2pcs) | DSA Utility Kit |
| | include: N(F)-N(F) adaptor (1pcs), N(M)-N(M) adaptor (1pcs), N(M)-SMA(F) adaptor (2pcs), N(M)-BNC(F) adaptor (2pcs), SMA(F)-SMA(F) adaptor (1pcs), SMA(M)-SMA(M) adaptor (1pcs), BNC T type adaptor (1pcs), 50 Ω SMA load (1pcs), 50 Ω BNC impedance adaptor (1pcs) | RF Adaptor Kit |
| | include: 50 Ω to 75 Ω adaptor (2pcs) | RF CATV Kit |
| | include: 6dB attenuator (1pcs), 10dB attenuator (2pcs) | RF Attenuator Kit |
| | 30dB high power attenuator, max. power 100W | ATT03301H |
| | N(M)-N(M) RF cable | CB-NM-NM-75-L-12G |
| | N(M)-SMA(M) RF cable | CB-NM-SMAM-75-L-12G |
| | RF demo kit (transmitter) | TX1000 |
| | RF demo kit (receiver) | RX1000 |
| | VSWR bridge, 1 MHz to 2 GHz | VB1020 |
| | VSWR bridge, 1 MHz to 3.2 GHz | VB1032 |
| | VSWR bridge, 800 MHz to 4 GHz | VB1040 |
| | VSWR bridge, 2 GHz to 8 GHz | VB1080 |
| | near field probe | NFP-3 |
| | EMI Pre-compliance test software | S1210 EMI Pre-compliance Software |
| | rack mount kit | RM-DSA800 |
| | soft carrying bag | BAG-G1 |
| | USB cable | CB-USBA-USBB-FF-150 |
| | USB to GPIB interface converter for instrument | USB-GPIB |



HEADQUARTER

RIGOL TECHNOLOGIES, INC.
No.156,Cai He Village,
Sha He Town,
Chang Ping District, Beijing,
102206 P.R.China
Tel: +86-10-80706688
Fax: +86-10-80705070
Electronic Measurement
Instrument service and support
email:EMD_support@rigol.com

EUROPE

RIGOL TECHNOLOGIES GmbH
Lindbergh str. 4
82178 Puchheim
Germany
Tel: 0049- 89/89418950
Email: info-europe@rigoltech.com

NORTH AMERICA

RIGOL TECHNOLOGIES,
USA INC.
10200 SW Allen Blvd, Suite C
Beaverton, OR 97005, USA
Toll free: 877-4-RIGOL-1
Office: (440) 232-4488
Fax: (216)-754-8107
Email: info@rigol.com

JAPAN

RIGOL TECHNOLOGIES JAPAN G.K.
Tonematsu Bldg. 5F, 2-33-8 Nihonbashi-
Ningyocho, Chuo-ku,
Tokyo 103-0013
Japan
Tel: +81-3-6264-9251
Fax: +81-3-6264-9252
Email: info-japan@rigol.com

RIGOL® is the registered trademark of **RIGOL** Technologies, Inc. Product information in this document subject to update without notice. For the latest information about **RIGOL**'s products, applications and services, please contact local **RIGOL** office or access **RIGOL** official website: www.rigol.com

