

DC POWER JACK (DC-006)

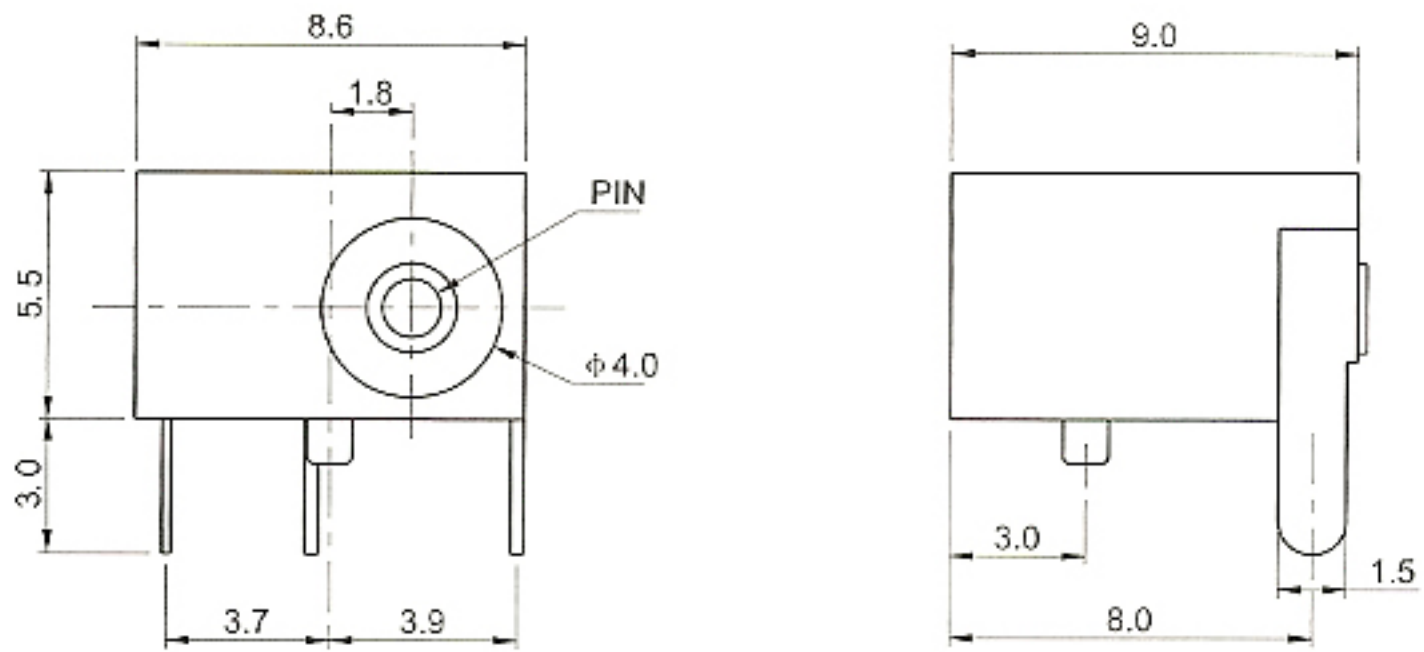

P.C.B LAYOUT TOP VIEW

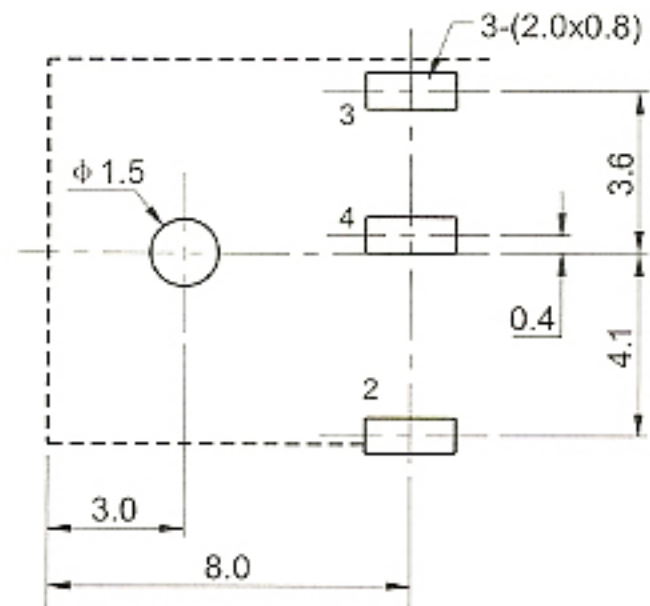

PIN	$\phi 1.0$	$\phi 1.3$
APPD		

