

NAIS

2 AMP. HIGH CAPACITY RELAY WITH HIGH SURGE VOLTAGE & HIGH BREAKDOWN VOLTAGE

TX-RELAYS

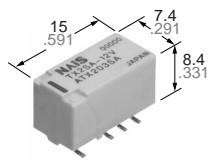
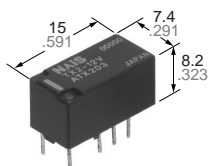

mm inch

FEATURES

- Breakdown voltage between contacts and coil: 2,000 V
- Surge withstand between contacts and coil: 2,500 V
- High contact capacity: 2 A 30 V DC
- Surface-mount type available

SPECIFICATIONS

Contact			
Arrangement		2 Form C	
Initial contact resistance, max. (By voltage drop 6 V DC 1 A)		100 mΩ	
Contact material		Gold-clad silver alloy	
Rating	Nominal switching capacity (resistive load)	2 A 30 V DC	
	Max. switching power (resistive load)	60 W	
	Max. switching voltage	220 V DC	
	Max. switching current	2 A	
	Min. switching capacity *1	10 μA 10 mV DC	
Nominal operating power	Single side stable	140 mW (1.5 to 24 V DC) 270 mW (48 V DC)	
	1 coil latching	100 mW (1.5 to 24 V DC)	
	2 coil latching	200 mW (1.5 to 24 V DC)	
Expected life (min. operations)	Mechanical (at 180 cpm)	10 ⁸	
	Electrical (at 20 cpm)	2 A 30 V DC resistive	10 ⁵
		1 A 30 V DC resistive	5×10 ⁵

Notes:

- *1 This value can change due to the switching frequency, environmental conditions, and desired reliability level, therefore it is recommended to check this with the actual load.
- *2 The upper limit for the ambient temperature is the maximum temperature that can satisfy the coil temperature rise. Under the packing condition, allowable temperature range is from -40 to +70°C -40°C to +158°F.

Remarks

- * Specifications will vary with foreign standards certification ratings.
- *1 Measurement at same location as "Initial breakdown voltage" section.
- *2 By resistive method, nominal voltage applied to the coil; contact carrying current: 2 A.
- *3 Nominal voltage applied to the coil, excluding contact bounce time.
- *4 Nominal voltage applied to the coil, excluding contact bounce time without diode.
- *5 Half-wave pulse of sine wave: 6 ms; detection time: 10 μs.
- *6 Half-wave pulse of sine wave: 6 ms.
- *7 Detection time: 10 μs.
- *8 Refer to 4. Conditions for operation, transport and storage mentioned in Cautions for use (Page 178).

Characteristics

Initial insulation resistance*1		Min. 1,000 MΩ (at 500 V DC)
Initial breakdown voltage	Between open contacts	1,000 Vrms for 1 min. (Detection current: 10 mA)
	Between contact sets	1,000 Vrms for 1 min. (Detection current: 10 mA)
	Between contact and coil	2,000 Vrms for 1 min. (Detection current: 10 mA)
Initial surge voltage	Between open contacts (10×160 μs)	1,500 V (FCC Part 68)
	Between contacts and coil (2×10 μs)	2,500 V (Bellcore)
Temperature rise*2 (at 20°C)		Max. 50°C
Operate time [Set time]*3 (at 20°C)		Max. 4 ms (Approx. 2 ms) [Max. 4 ms (Approx. 2 ms)]
Release time [Reset time]*4 (at 20°C)		Max. 4 ms (Approx. 1 ms) [Max. 4 ms (Approx. 2 ms)]
Shock resistance	Functional*5	Min. 750 m/s ² {75 G}
	Destructive*6	Min. 1,000 m/s ² {100 G}
Vibration resistance	Functional*7	196 m/s ² {20 G}, 10 to 55 Hz at double amplitude of 3.3 mm
	Destructive	294 m/s ² {30G}, 10 to 55 Hz at double amplitude of 5 mm
Conditions for operation, transport and storage*8 (Not freezing and condensing at low temperature)	Ambient temperature *2	-40°C to +85°C (up to 24 V coil) -40°F to +185°F (up to 24 V coil) -40°C to +70°C (48 V coil) -40°F to +158°F (48 V coil)
	Humidity	5 to 85% R.H.
Unit weight		Approx. 2 g .071 oz

ORDERING INFORMATION

Ex. TX 2 SA - L - H - 3V - Z

Contact arrangement	Surface-mount availability	Operating function	Terminal shape	Coil voltage (DC)	Packing style
2: 2 Form C	Nil: Standard PC board terminal type or self-clinching terminal type SA: Standard surface-mount terminal type SL: High connection reliability surface-mount terminal type SS: Space saving surface-mount terminal type	Nil: Single side stable L: 1 coil latching L2: 2 coil latching	Nil: Standard PC board terminal or surface-mount terminal H: Self-clinching terminal	1.5, 3, 4.5, 5, 6, 9, 12, 24, 48* V	Nil: Tube packing Z: Tape and reel packing (picked from the 8/9/10/12-pin side)

- Notes: 1. Tape and reel (picked from 1/3/4/5-pin side) is also available by request. Part number suffix "-X" is needed when ordering. (ex.) TX2SA-3 V-X
2. Tape and reel packing symbol "-Z" or "-X" are not marked on the relay.
- *48 V coil type: Single side stable only

Surface-mount terminal variation

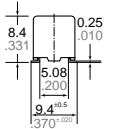
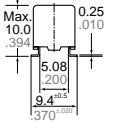
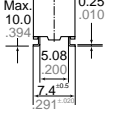
Variation	Terminal style	Usable conditions based on terminal connection solder reliability	
		Normal environments (indoor)	Drastic temperature fluctuations (outdoor)
SA type (Standard surface-mount terminal type)		Recommended	—
SL type (Highly connection reliability surface-mount terminal type)		Recommended	Recommended
SS type (Space saving surface-mount terminal type)		Recommended	Recommended

TYPES AND COIL DATA (at 20°C 68°F)

1) Standard PC board terminal type and self-clinching terminal type

1. Single side stable

Part No.		Nominal voltage, V DC	Pick-up voltage, V DC (max.)	Drop-out voltage, V DC (min.)	Nominal operating current, mA (±10%)	Coil resistance, Ω (±10%)	Nominal operating power, mW	Max. allowable voltage, V DC
Standard PC board terminal	Self-clinching terminal							
TX2-1.5 V	TX2-H-1.5 V	1.5	1.13	0.15	93.8	16	140	2.2
TX2-3 V	TX2-H-3 V	3	2.25	0.3	46.7	64.3	140	4.5
TX2-4.5 V	TX2-H-4.5 V	4.5	3.38	0.45	31	145	140	6.7
TX2-5 V	TX2-H-5 V	5	3.75	0.5	28.1	178	140	7.5
TX2-6 V	TX2-H-6 V	6	4.5	0.6	23.3	257	140	9
TX2-9 V	TX2-H-9 V	9	6.75	0.9	15.5	579	140	13.5
TX2-12 V	TX2-H-12 V	12	9	1.2	11.7	1,028	140	18
TX2-24 V	TX2-H-24 V	24	18	2.4	5.8	4,114	140	36
TX2-48 V	TX2-H-48 V	48	36	4.8	5.6	8,533	270	57.6

2. 1 Coil latching

Part No.		Nominal voltage, V DC	Set voltage, V DC (max.)	Reset voltage, V DC (max.)	Nominal operating current, mA (±10%)	Coil resistance, Ω (±10%)	Nominal operating power, mW	Max. allowable voltage, V DC
Standard PC board terminal	Self-clinching terminal							
TX2-L-1.5 V	TX2-L-H-1.5 V	1.5	1.13	1.13	66.7	22.5	100	2.2
TX2-L-3 V	TX2-L-H-3 V	3	2.25	2.25	33.3	90	100	4.5
TX2-L-4.5 V	TX2-L-H-4.5 V	4.5	3.38	3.38	22.2	202.5	100	6.7
TX2-L-5 V	TX2-L-H-5 V	5	3.75	3.75	20	250	100	7.5
TX2-L-6 V	TX2-L-H-6 V	6	4.5	4.5	16.7	360	100	9
TX2-L-9 V	TX2-L-H-9 V	9	6.75	6.75	11.1	810	100	13.5
TX2-L-12 V	TX2-L-H-12 V	12	9	9	8.3	1,440	100	18
TX2-L-24 V	TX2-L-H-24 V	24	18	18	4.2	5,760	100	36

3. 2 Coil latching

Part No.		Nominal voltage, V DC	Set voltage, V DC (max.)	Reset voltage, V DC (max.)	Nominal operating current, mA (±10%)	Coil resistance, Ω (±10%)	Nominal operating power, mW	Max. allowable voltage, V DC
Standard PC board terminal	Self-clinching terminal							
TX2-L2-1.5 V	TX2-L2-H-1.5 V	1.5	1.13	1.13	133.9	11.2	200	2.2
TX2-L2-3 V	TX2-L2-H-3 V	3	2.25	2.25	66.7	45	200	4.5
TX2-L2-4.5 V	TX2-L2-H-4.5 V	4.5	3.38	3.38	44.5	101.2	200	6.7
TX2-L2-5 V	TX2-L2-H-5 V	5	3.75	3.75	40	125	200	7.5
TX2-L2-6 V	TX2-L2-H-6 V	6	4.5	4.5	33.3	180	200	9
TX2-L2-9 V	TX2-L2-H-9 V	9	6.75	6.75	22.2	405	200	13.5
TX2-L2-12 V	TX2-L2-H-12 V	12	9	9	16.7	720	200	18
TX2-L2-24 V	TX2-L2-H-24 V	24	18	18	8.3	2,880	200	36

Notes:

1. Specified value of pick-up, drop-out, set and reset voltage is with the condition of square wave coil pulse.

2. Standard packing: Tube: 40 pcs.; Case: 1,000 pcs.

3. In case of 5 V transistor drive circuit, it is recommended to use 4.5 V type relay.

2) Surface-mount terminal type

1. Single side stable

Part No.	Nominal voltage, V DC	Pick-up voltage, V DC (max.)	Drop-out voltage, V DC (min.)	Nominal operating current, mA ($\pm 10\%$)	Coil resistance, Ω ($\pm 10\%$)	Nominal operating power, mW	Max. allowable voltage, V DC
TX2SO-1.5 V	1.5	1.13	0.15	93.8	16	140	2.2
TX2SO-3 V	3	2.25	0.3	46.7	64.3	140	4.5
TX2SO-4.5 V	4.5	3.38	0.45	31	145	140	6.7
TX2SO-5 V	5	3.75	0.5	28.1	178	140	7.5
TX2SO-6 V	6	4.5	0.6	23.3	257	140	9
TX2SO-9 V	9	6.75	0.9	15.5	579	140	13.5
TX2SO-12 V	12	9	1.2	11.7	1,028	140	18
TX2SO-24 V	24	18	2.4	5.8	4,114	140	36
TX2SO-48 V	48	36	4.8	5.6	8,533	270	57.6

2. 1 coil latching

Part No.	Nominal voltage, V DC	Set voltage, V DC (max.)	Reset voltage, V DC (max.)	Nominal operating current, mA ($\pm 10\%$)	Coil resistance, Ω ($\pm 10\%$)	Nominal operating power, mW	Max. allowable voltage, V DC
TX2SO-L-1.5 V	1.5	1.13	1.13	66.7	22.5	100	2.2
TX2SO-L-3 V	3	2.25	2.25	33.3	90	100	4.5
TX2SO-L-4.5 V	4.5	3.38	3.38	22.2	202.5	100	6.7
TX2SO-L-5 V	5	3.75	3.75	20	250	100	7.5
TX2SO-L-6 V	6	4.5	4.5	16.7	360	100	9
TX2SO-L-9 V	9	6.75	6.75	11.1	810	100	13.5
TX2SO-L-12 V	12	9	9	8.3	1,440	100	18
TX2SO-L-24 V	24	18	18	4.2	5,760	100	36

3. 2 coil latching

Part No.	Nominal voltage, V DC	Set voltage, V DC (max.)	Reset voltage, V DC (max.)	Nominal operating current, mA ($\pm 10\%$)	Coil resistance, Ω ($\pm 10\%$)	Nominal operating power, mW	Max. allowable voltage, V DC
TX2SO-L2-1.5 V	1.5	1.13	1.13	133.9	11.2	200	2.2
TX2SO-L2-3 V	3	2.25	2.25	66.7	45	200	4.5
TX2SO-L2-4.5 V	4.5	3.38	3.38	44.5	101.2	200	6.7
TX2SO-L2-5 V	5	3.75	3.75	40	125	200	7.5
TX2SO-L2-6 V	6	4.5	4.5	33.3	180	200	9
TX2SO-L2-9 V	9	6.75	6.75	22.2	405	200	13.5
TX2SO-L2-12 V	12	9	9	16.7	720	200	18
TX2SO-L2-24 V	24	18	18	8.3	2,880	200	36

○: For each surface-mounted terminal variation, input the following letter.

SA type: A, SL type: L, SS type: S

Notes:

- Specified value of pick-up, drop-out, set and reset voltage is with the condition of square wave coil pulse.
- Standard packing: Tube: 40 pcs.; Case: 1,000 pcs.
- Tape and reel packing is also available for surface-mount type by request. Part number suffix "-X" or "-Z" is needed when ordering.
In this case, "X" or "Z" are not marked on the relay.
Quantity in tape and reel: 500 pcs.

(ex.) • TX2SA-3V-X

└ Picked from the 1/3/4/5-pin side

• TX2SA-L-3V-Z

└ Picked from the 8/9/10/12-pin side

- In case of 5 V transistor drive circuit, it is recommended to use 4.5 V type relay.

DIMENSIONS

1. Single side stable and 1 coil latching type

Standard PC board terminal

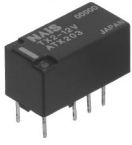

Self clinching terminal

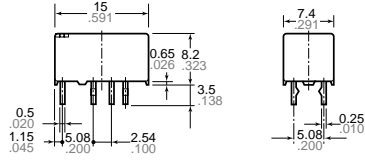
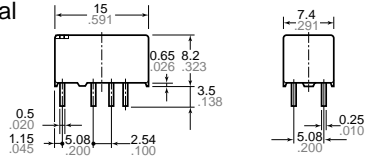

General tolerance: $\pm 0.3 \pm 0.012$

PC board pattern
(Copper-side view)

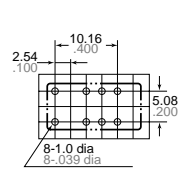

Tolerance: $\pm 0.1 \pm 0.004$

Schematic (Bottom view)
Single side stable (Deenergized condition) 1 coil latching (Reset condition)

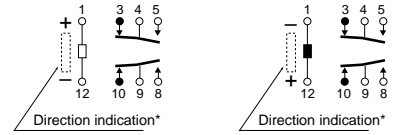

*Orientation stripe located on top of relay.

Surface-mount terminal
SA type



SL type

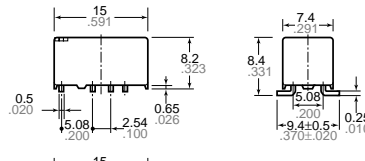

General tolerance: $\pm 0.3 \pm 0.012$

Suggested mounting pad
(Top view)

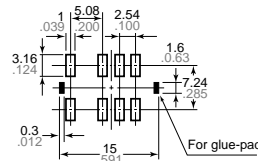

Tolerance: $\pm 0.1 \pm 0.004$

Schematic (Top view)
Single side stable (Deenergized condition) 1 coil latching (Reset condition)

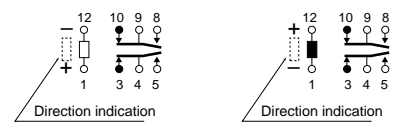

SS type

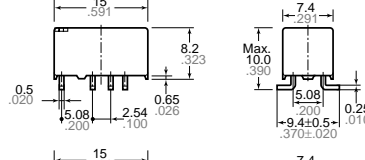

General tolerance: $\pm 0.3 \pm 0.012$

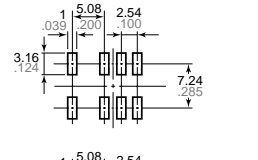

2. Coil latching type

Standard PC board terminal

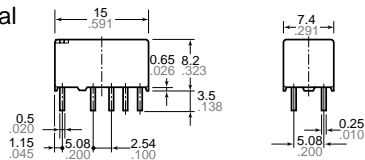

General tolerance: $\pm 0.3 \pm 0.012$

PC board pattern
(Copper side view)

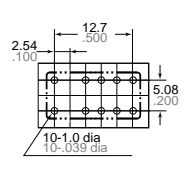

Tolerance: $\pm 0.1 \pm 0.004$

Schematic (Bottom view)
2 coil latching (Reset condition)

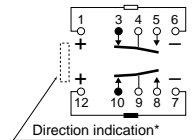

Self clinching terminal

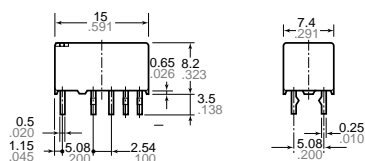

General tolerance: $\pm 0.3 \pm 0.012$

Suggested mounting pad (Top view)

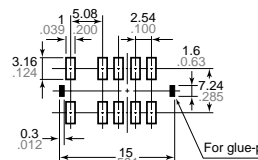

Tolerance: $\pm 0.1 \pm 0.004$

Schematic (Top view)
1 coil latching (Reset condition)

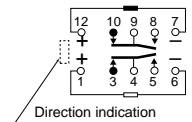

Surface-mount terminal
SA type

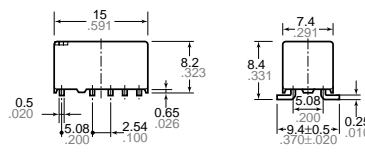

General tolerance: $\pm 0.3 \pm 0.012$

SL type

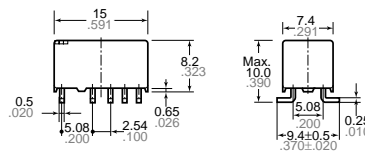

General tolerance: $\pm 0.3 \pm 0.012$

SS type

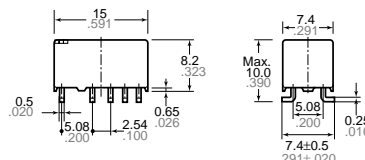

General tolerance: $\pm 0.3 \pm 0.012$

REFERENCE DATA

1. Maximum switching capacity

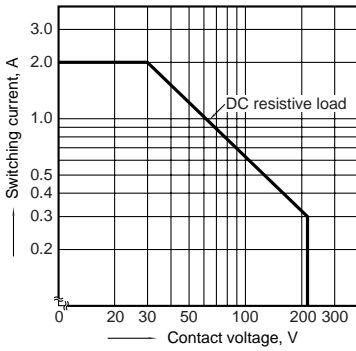

2. Life curve

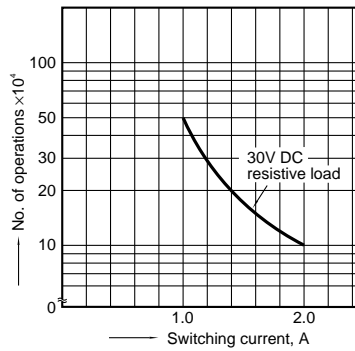

3. Mechanical life

Tested sample: TX2-5V, 10 pcs.
Operating frequency: 180 cpm

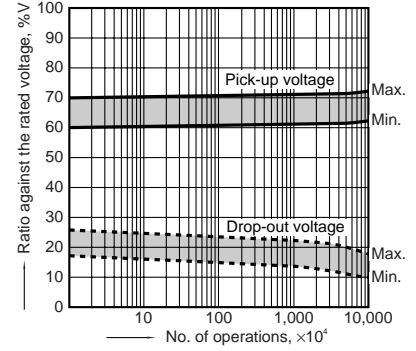

4. Electrical life

Tested sample: TX2-5V, 6 pcs.
Operating frequency: 20 cpm

Change of pick-up and drop-out voltage

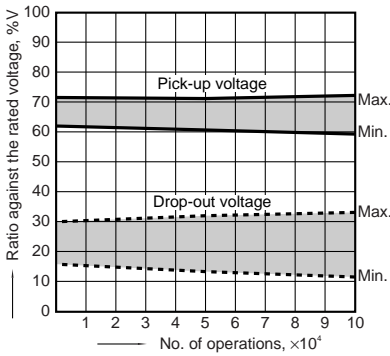

Change of contact resistance

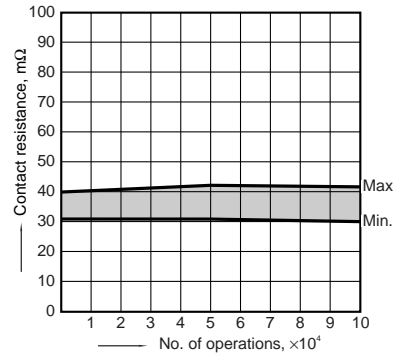

5-(1). Coil temperature rise

Tested sample: TX2-5V, 6 pcs.
Point measured: Inside the coil
Ambient temperature: 25°C 77°F, 85°C 185°F

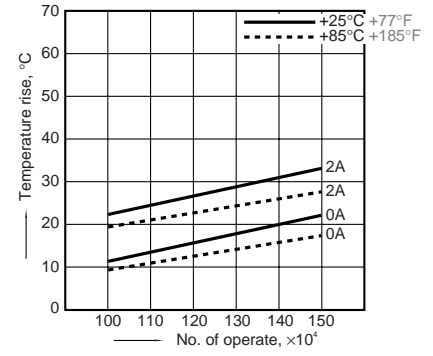

5-(2). Coil temperature rise

Tested sample: TX2-48V, 6 pcs.
Point measured: Inside the coil
Ambient temperature: 25°C 77°F, 70°C 158°F

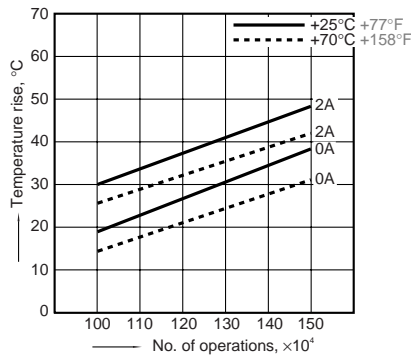

6-(1). Operate and release time (with diode)

Tested sample: TX2-5V, 10 pcs.

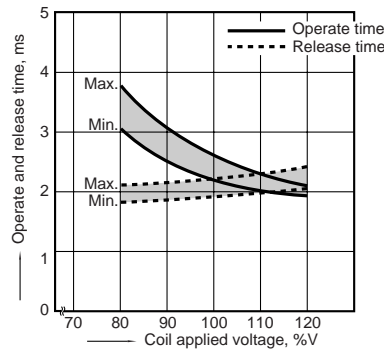

6-(2). Operate and release time (without diode)

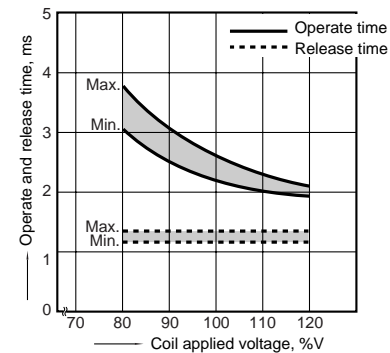

7. Distribution of pick-up and drop-out voltage

Tested sample: TX2-5V, 50 pcs.

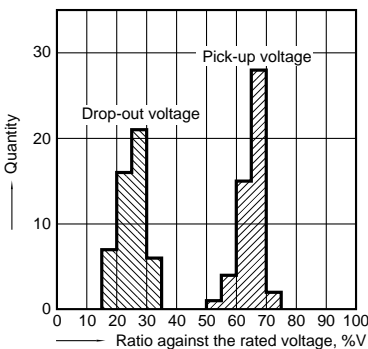

8. Distribution of set and reset voltage

Tested sample: TX2-L2-12V, 30 pcs.

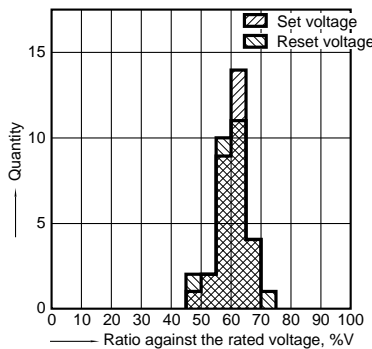

9. Ambient temperature characteristics

Tested sample: TX2-5V, 5 pcs.

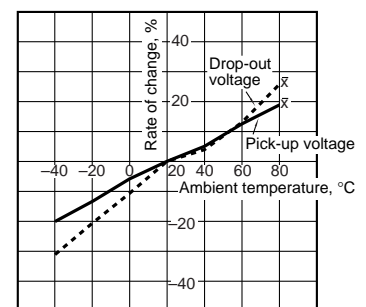

10. Distribution of contact resistance
Tested sample: TX2-5V, 30 pcs. (30 × 4 contacts)

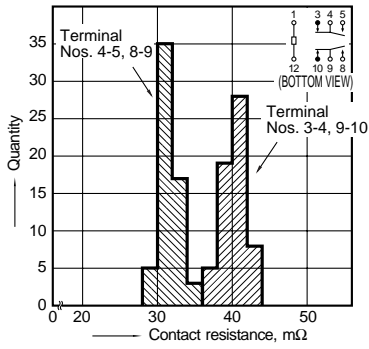

11-(1). High frequency characteristics
Tested sample: TX2-12V, 2 pcs.
Isolation characteristics

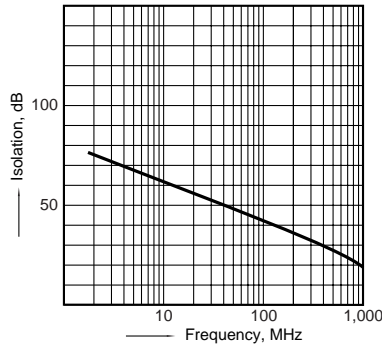

11-(2). High frequency characteristics
Tested sample: TX2-12V, 2 pcs.
Insertion loss characteristics

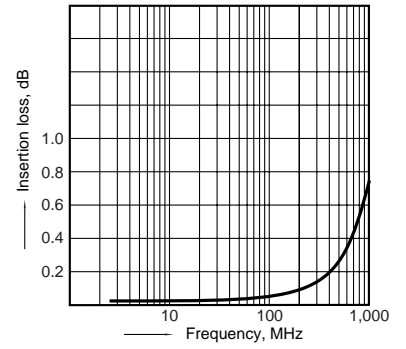

12-(1). Malfunctional shock (single side stable)
Tested sample: TX2-5V, 6 pcs

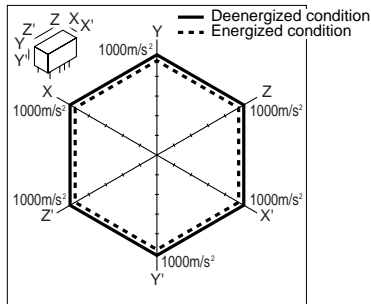

12-(2). Malfunctional shock (latching)
Tested sample: TX2-L2-12V, 6 pcs.

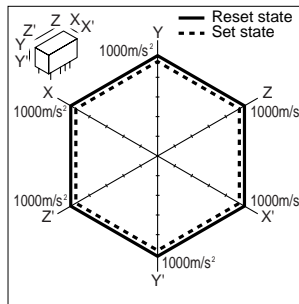

13-(1). Influence of adjacent mounting

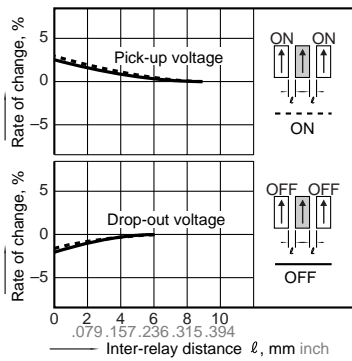

13-(2). Influence of adjacent mounting

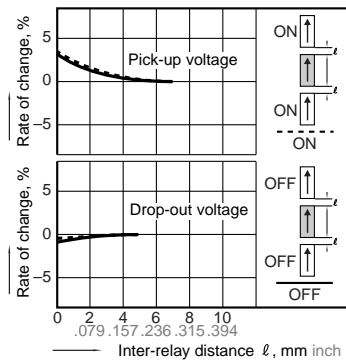

13-(3). Influence of adjacent mounting

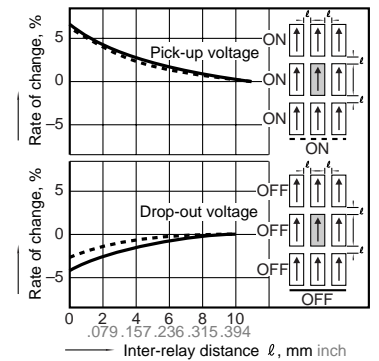

14. Pulse dialing test
Tested sample: TX2-5V, 6 pcs.
(35 mA 48 V DC wire spring relay load)

Circuit

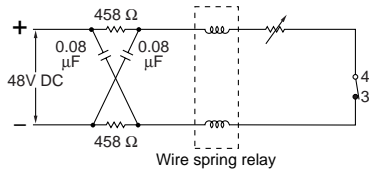

Change of pick-up and drop-out voltage

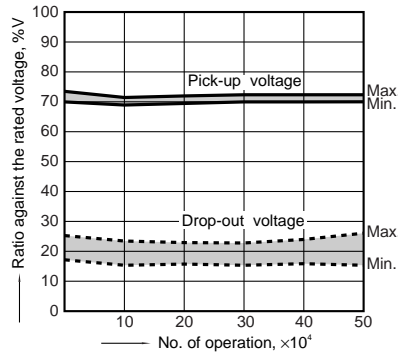

Change of contact resistance

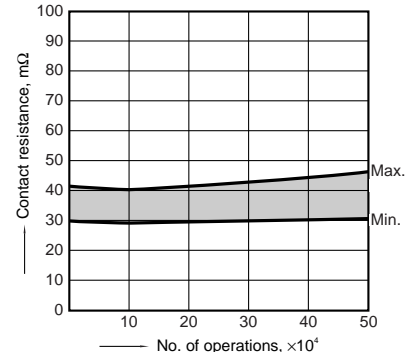

Note: Data of surface-mount type are the same as those of PC board terminal type.

For Cautions for Use, see Page 178 and 179.