



Product specifications

TYPE : 3mm Piranha Red LED

Part Number: G03RC31

Lens Color: Water clear

● **Features:**

- 1. Long operating life**
- 2. Instant light**
- 3. Low voltage operated**
- 4. Cool beam, safe to the touch**
- 5. More energy efficient than incandescent and most halogen lamps**
- 6. Widely used in the lighting , industrial and electronics products.**

● **Package Outline Dimension:**

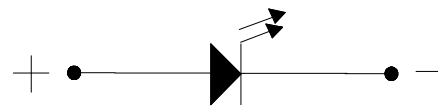
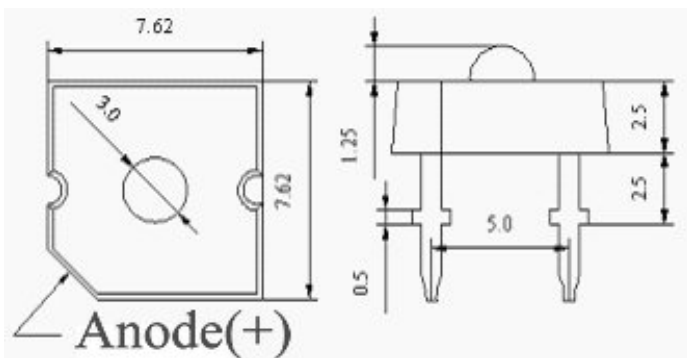

NOTES:

- 1. All dimensions are in millimeters;**
- 2. Tolerances are $\pm 0.1\text{mm}$, unless otherwise noted.**



● Typical Electrical & Optical Characteristics (Ta=25°C)

Part Number: G03RC31						
Absolute maximum ratings (Ta=25°C)						
Parameter	Symbol	Value				Unit
Forward current	If	40				mA
Reverse voltage	Vr	5				V
Power dissipation	Pd	150				mW
Soldering Temperature	Tsol	260(for 5seconds)				°C
Operating temperature range	Top	-25~+80				°C
Storage temperature range	Tstg	-30~+80				°C
Peak pulsing current (1/8 duty f=1KHz)	Ifp	240				mA
Electrostatic discharge	ESD	>3000				V
Electr-Optical characteristics(Ta=25°C,If=50mA)						
Parameter	Test Condition	symbol	Value			Unit
			Min	Typ	Max	
Peak Wavelength	If=20mA	λd	620	---	630	
Color temperature	If=20mA	Tc	--		--	K
Forward voltage	If=20mA	Vf	1.8	---	2.4	V
Luminous Intensity	If=20mA	Iv	600	--	1200	mcd
Luminous Flux	If=20mA	ϕ	1	---	2	lm
Viewing angle at 50% IV	If=20mA	$\theta //2$	---	60	---	Deg
Reverse current	VR=8V	Ir	---	5	---	μA



Part Number: **G03RC31**

● Typical Electro-Optical Characteristics Curves

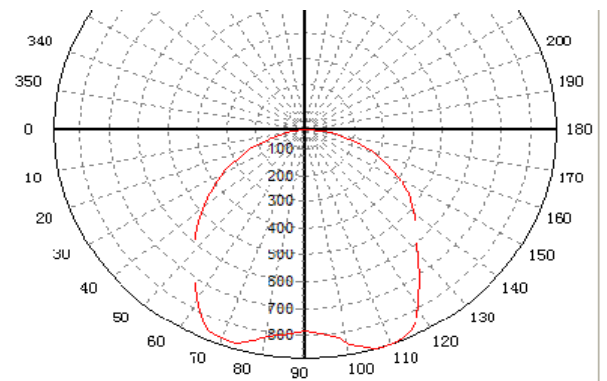
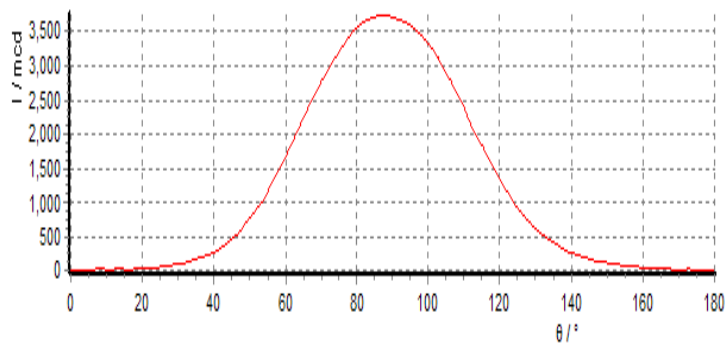
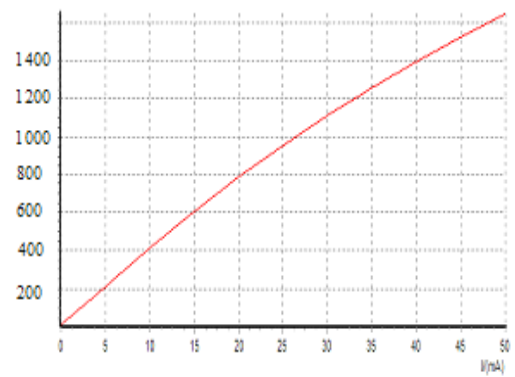
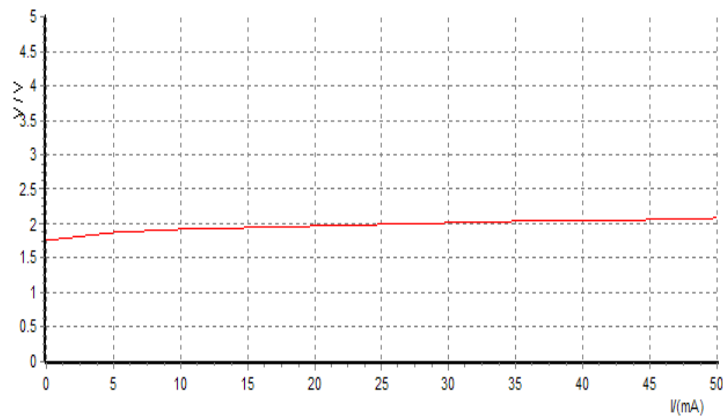
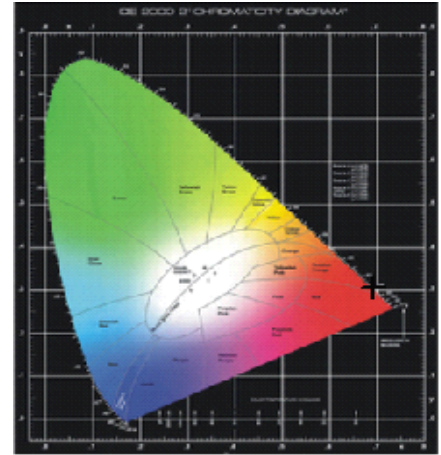
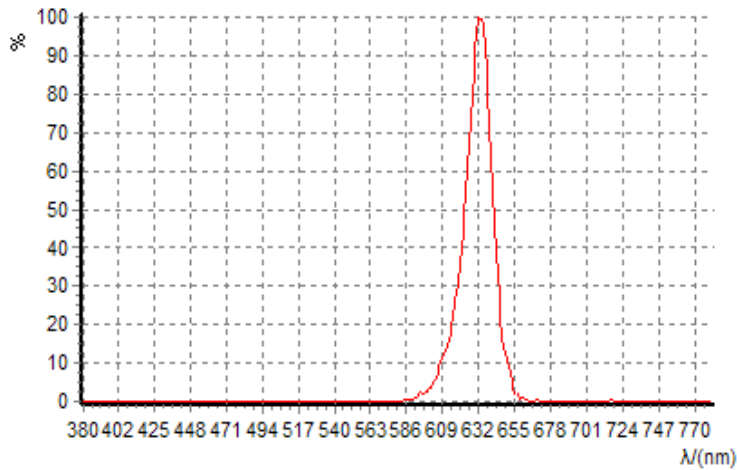

角度-光强 极坐标分布图



Part Number: G03RC31

● **Reliability test items and conditions:**

No.	Test item	Test condition	Sample size	Ac/Re
1	DC Operation life	If=DC20mA Temp:Room temperature Test time:1000hrs	22	0/1
2	Hight temperature Hight humidity	Temp.:+85°C RH=85%HR Test time:1000hrs	22	0/1
3	Thermal shock	-35°C ~~~~ +85°C 20min 10s 20min Test time:300cycles	22	0/1
4	Hight temperature storage	Hight temp.:+85°C Test time:1000hrs	22	0/1
5	Low temperature storage	Low temp.: -35°C Test time:1000hrs	22	0/1
6	Temperature cycle	-35°C ~~~~ +100°C 15min 5min 15min Test time:300cycles	22	0/1
7	Reflow soldering	Operation heating: 260°C(Max.) within 10seconds(Max.)	22	0/1

● **Judgement criteria of failure for the reliability**

- ※ Iv: Below 50% of the initial value
- ※ Vf: Over 20% of the upper limit value
- ※ Ir: Over 2 times of the upper limit value

Note: Measurement should be taken between 2 hours and after the test leds have been returned to normal ambient condition after completion of each test.



Part Number: G03RC31

● Precautions for use:

1. Temperature in use

Since the light generated inside the LED needs to be emitted to outside efficiently , a resin with high light transparency is used, therefore, additives to improve the heat resistance or moisture resistance(silica gel,etc) which are used for semiconductors products such as transistors cannot be added to the resin.

Consequently, the heat resistant ability of the resin used for LED is usually low,therefore, please be careful of the following points:

Avoid applying external force, stress and excessive vibration to the resins and terminals at high temperature. The glass transition temperature of epoxy resin used for the LED is approximately

120-130°C. If the temperature exceeding the limit, the coefficient of linear expansion of the resin

doubles or more compared to that at normal temperature and the resin will be softened.

And if some external force or stress is applied at that time, it may cause a wire damage.

2. Soldering

After soldering, avoid applying external force, stress and excessive vibration until the products down to the room temperature(the same to terminal leads).

3. Designing

Care must be taken to provide the current limiting resistor in the circuit so as to drive the LED within the rated figures, Also caution should be taken not to overload LED with exorbitant voltage at the turning ON and OFF of the circuit.

When using the pulse drive care must be taken to keep the average current within the rated figures, Also the circuit should be designed so as to be subjected to reverse voltage when turning off the LED.

4. Storage

In order to avoid the absorption of moisture, it is recommended to solder LED as soon as possible after unpacking the sealed bags.

5. Anti-static electricity

As the blue, green, white and purple are sensitive to the ESD, so during the handling, soldering , testing and packing process the anti-static measurements must be applied. Otherwise the LED will be damaged.