

SCHT-SF7-4P

온/습도센서 전용필터캡

호환 모델 : [SENSIRION] SHT85, SHT75, SHT71



1. Key Features

- 온/습도 센서용 전용필터캡
- 센시리온사의 온/습도센서 SHT85, SHT75, SHT71 모델과 호환 가능
- Pin type 센서를 쉽게 장착할 수 있는 결합 구조의 장착솔루션
- 충격, 먼지, 벌레 등 외부 오염 물질로부터 센서를 보호하는 디자인 설계
- 수분안정성, 전기적, 기계적 특성이 우수한 소재로 제작
- 센서클라우드의 센서 노하우를 금형기술에 적용하여 직접 생산한 국산 제품

2. Parts list

			SCHT - SF7 - 4P		
			No.	Part name	Quantity
<p>1, 2 3 4, 5, 6</p>	1	Cap	1		
	2	Stainless Mesh	1		
	3	Sensor Connection PCB	1		
	4	Body	1		
	5	Rubber - Ring	1		
	6	Pin	4		

3. Technical specifications

Properties	Value	Condition & Method
Operating range	-40 to 220°C (-40 to 428°F)	Cap and body
Melting point	220°C (428°F)	DSC, Cap and body
Material	PA6 GF30	Cap and body
Material color	Black	Cap and body
Flame Resistance	HB	UL94
Breakdown voltage	20 KV/mm	ASTM D149
Resistivity	$10^{15} \Omega \cdot \text{Cm}$	ASTM D257
Filter	Stainless 2000 mesh	Filter
Filter color	Silver	Filter

4. Assembly example

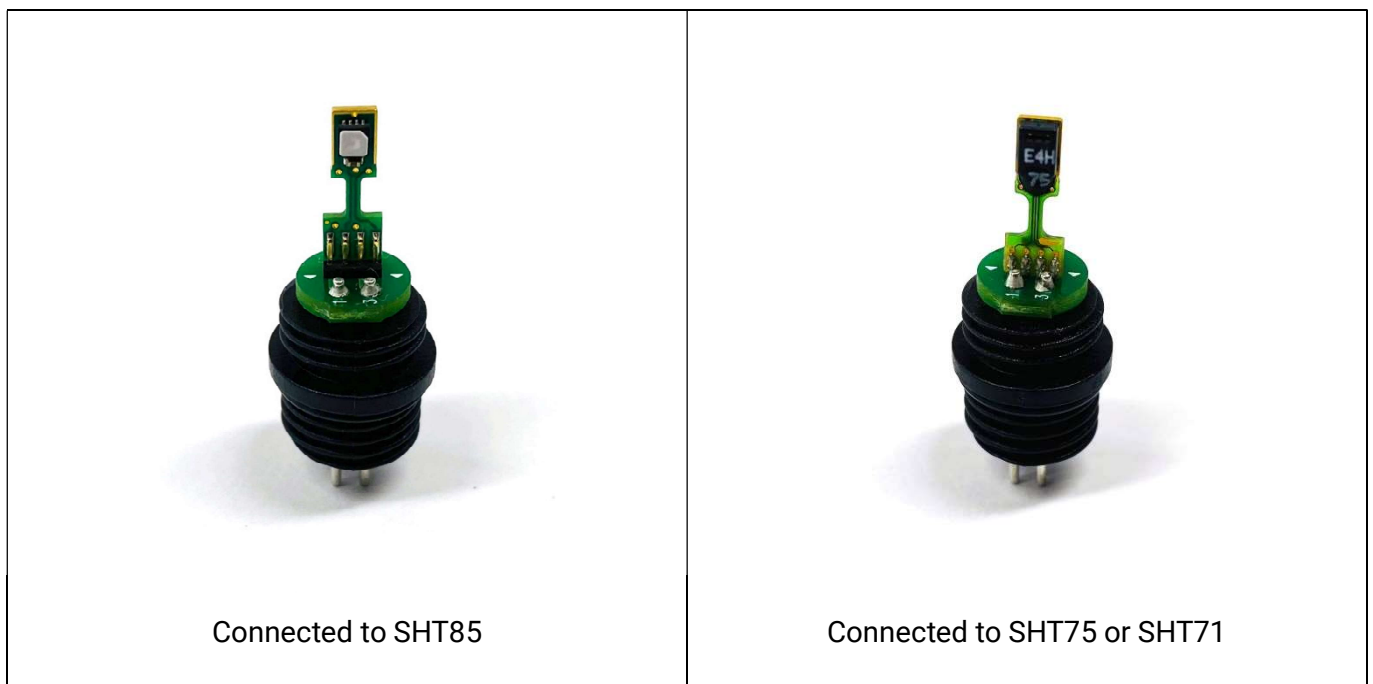

5. Direction of Sensor (PCB Top View)

Unit : mm

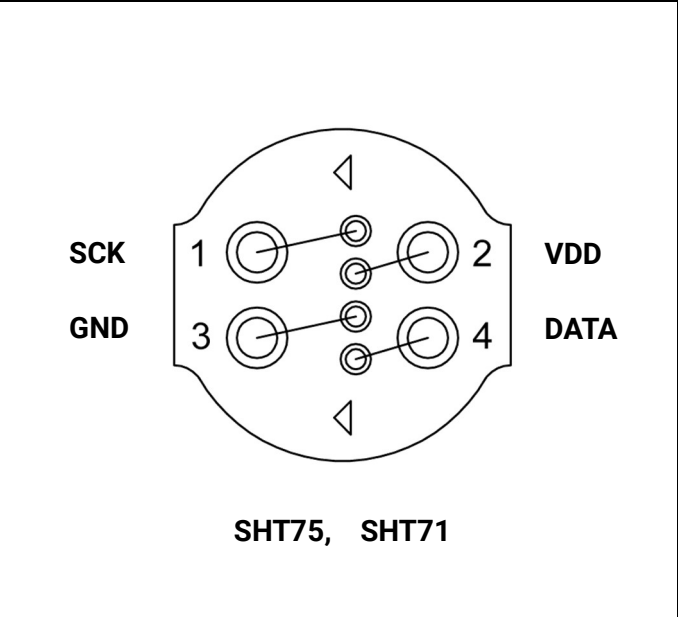
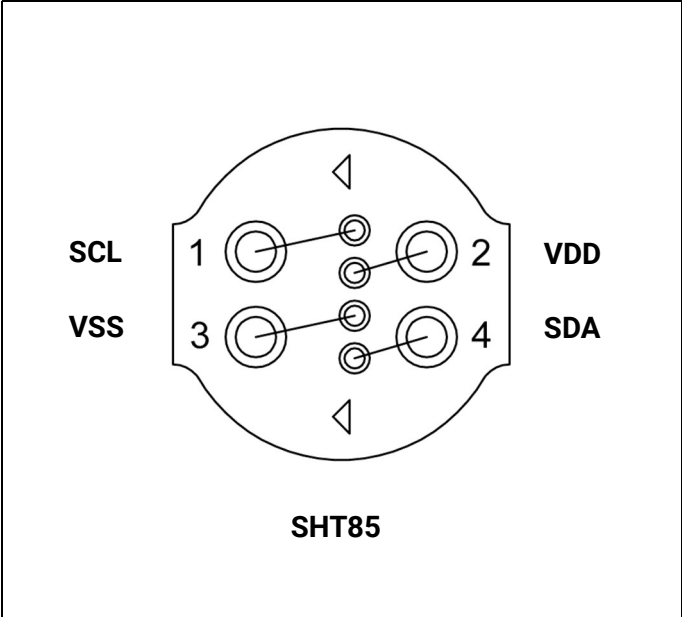
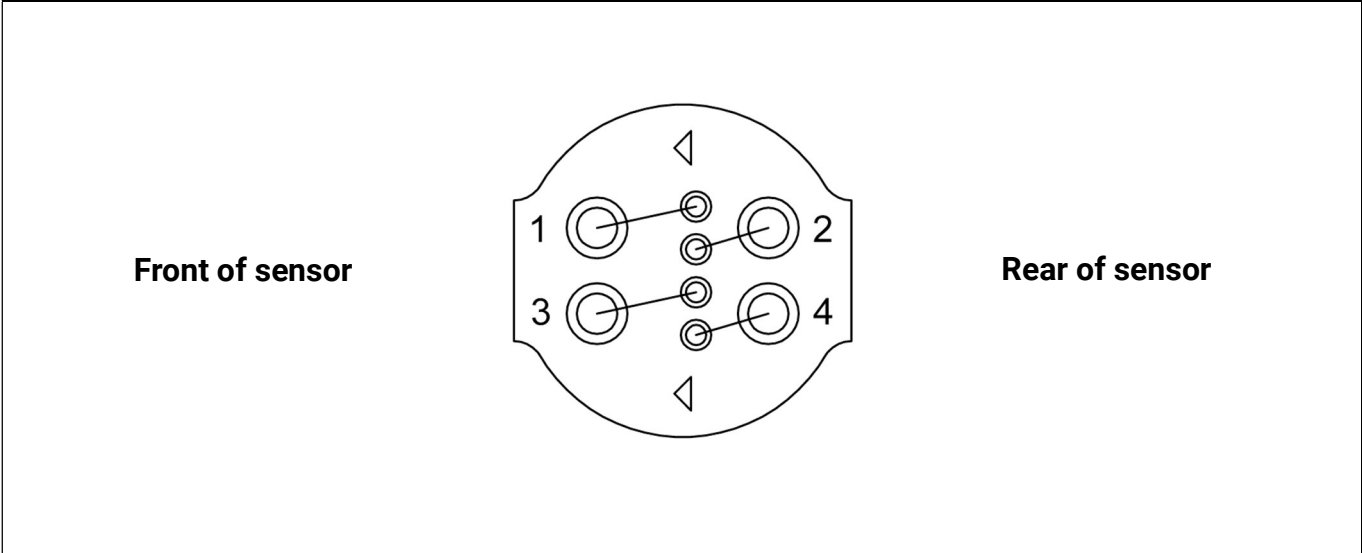
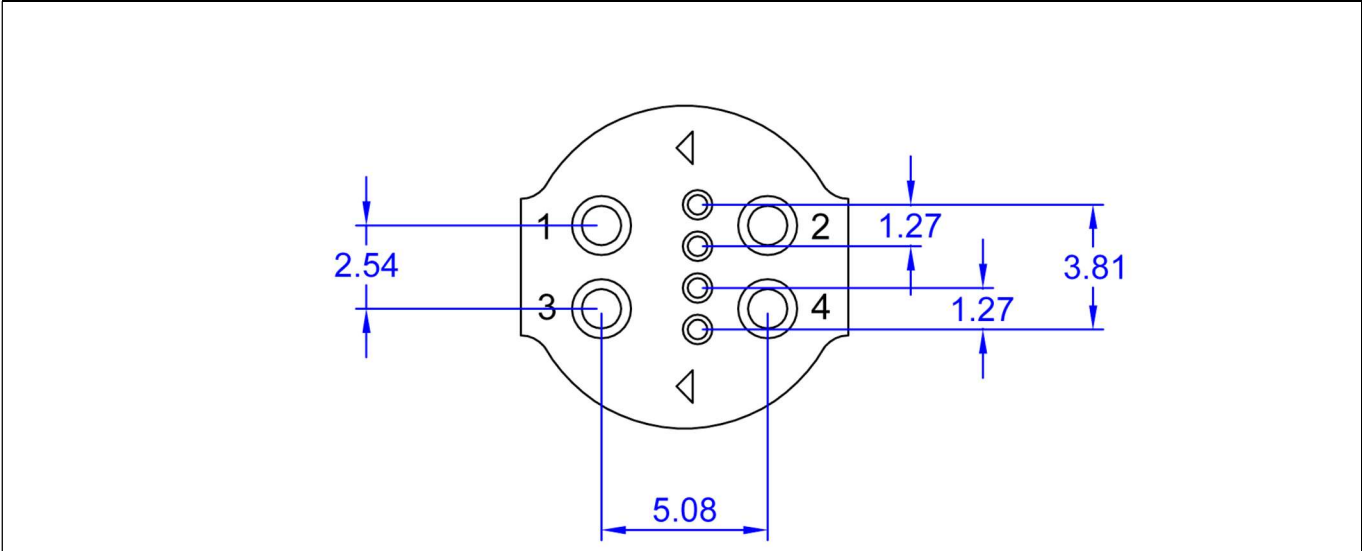

6. Assembly sequence

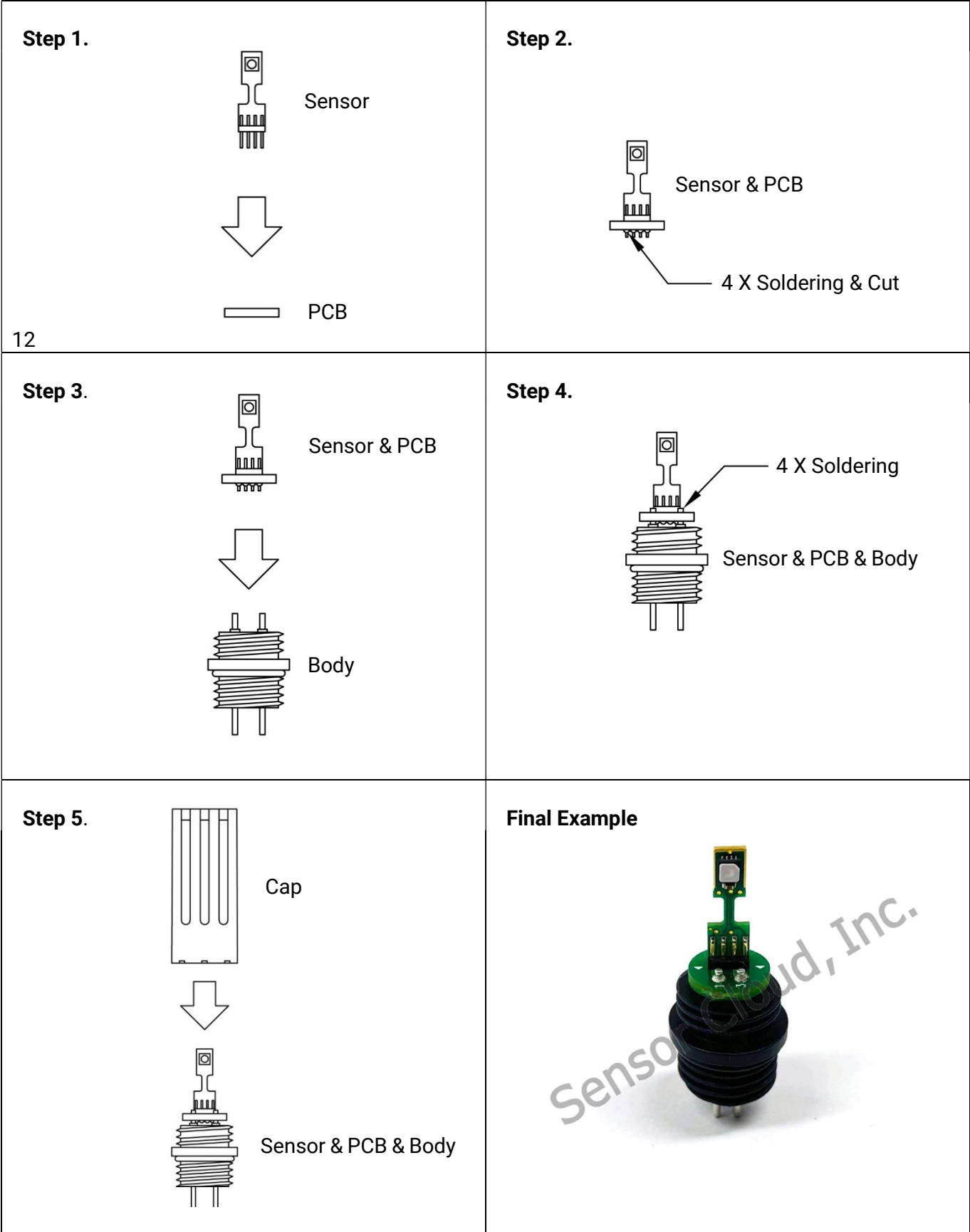

7. Dimensions

Unit : mm

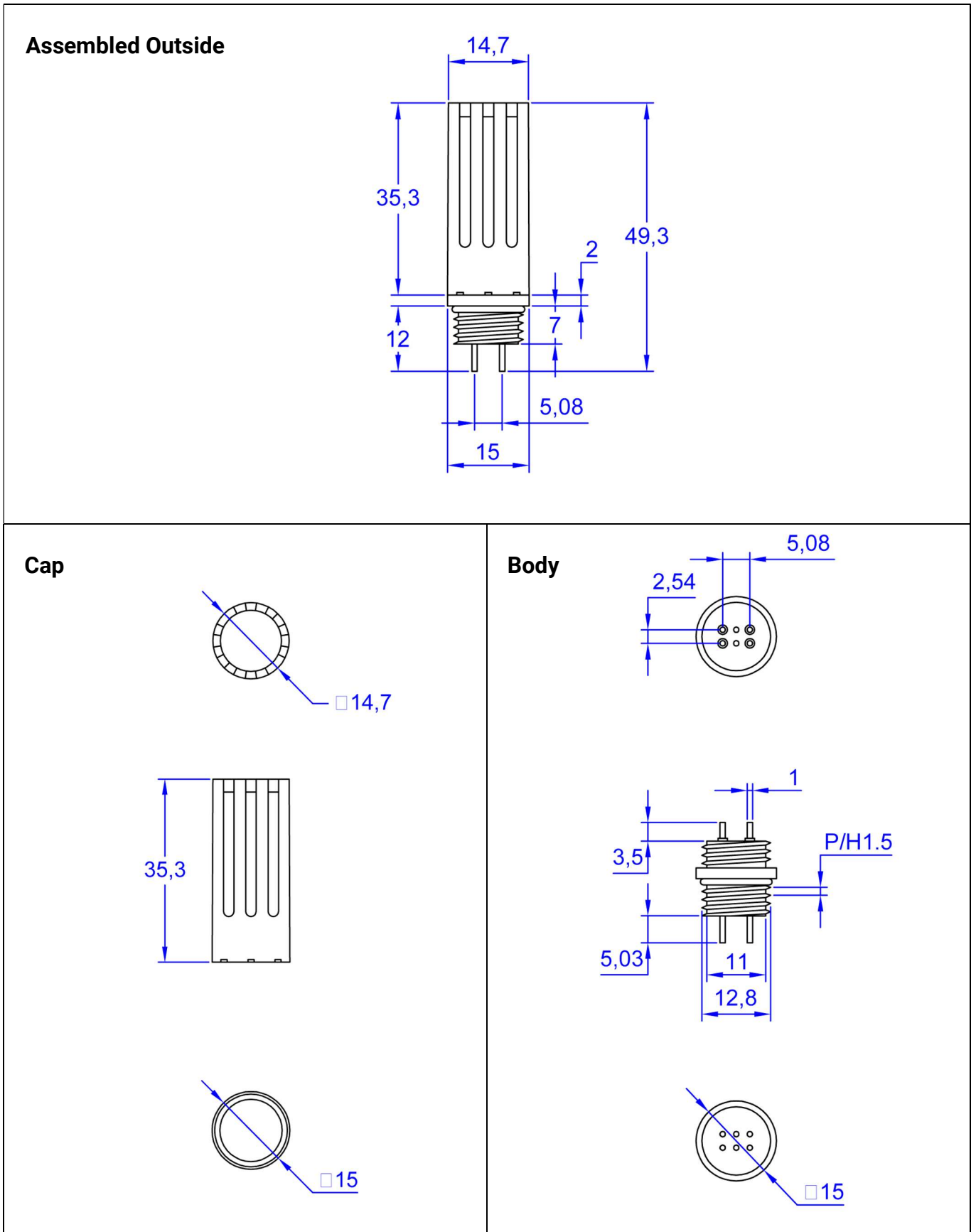

8. Ordering Information

No.	Product Name	Description
1	SCHT-SF7-4P	온/습도센서 연결 및 보호 구조의 4핀 전용필터캡

9. Product Family

No.	Product Name	Description
1	SCHT-SF7-6P	온/습도센서 모듈 SCHT-M30 연결 및 보호 구조의 6핀 전용필터캡
2	SCHT-M30	온/습도센서 SHT30, 콘덴서, 풀업저항으로 구성된 센서 모듈 (I2C통신)
3	SCHT-SF7-SP	전용필터캡 SCHT-SF7-4P, SCHT-SF7-6P 연결 가능한 스테인리스 바디킷

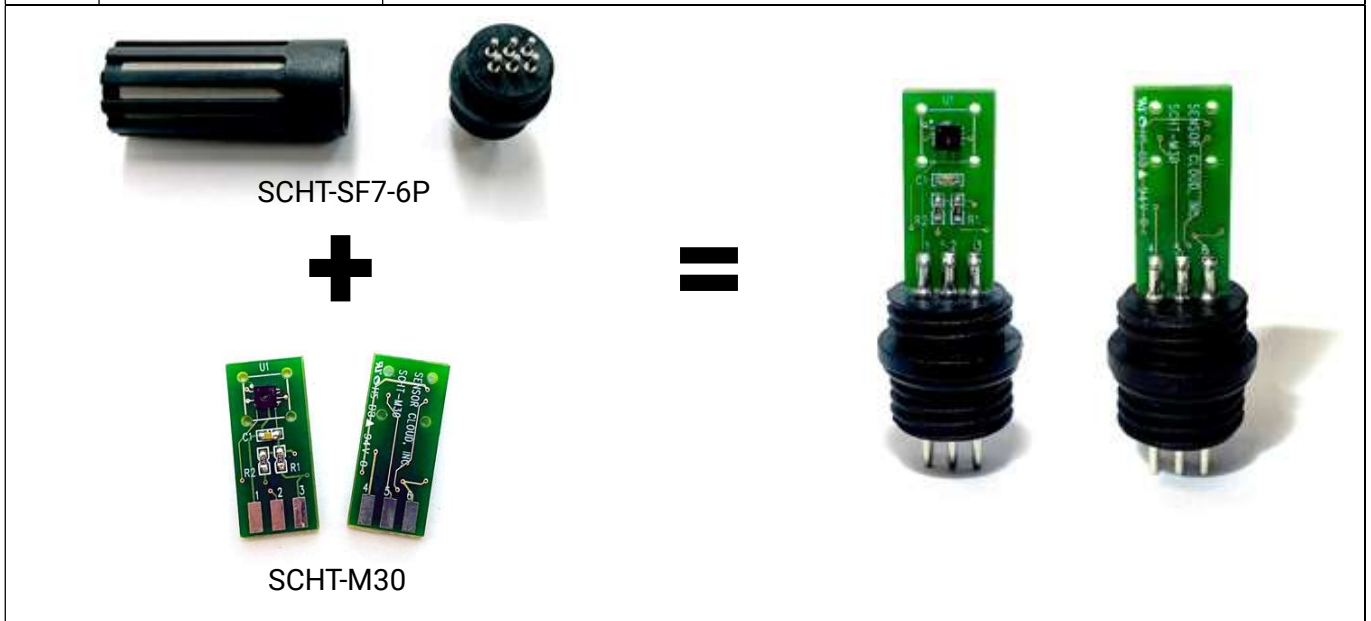

10. Revision History

Date	Version	Description
April 01, 2020	V1.0	- First document
April 18, 2020	V1.1	- Changed font and form design - Added product family

**Headquarters &
R&D Center & Factory**

Sensor Cloud, Inc.
#202, 8, Suseong-ro,
Gwonseon-gu, Suwon-si,
Gyeonggi-do, KOREA
(ZIP. 16426)
Tel : +82-31-216-9798
Fax: +82-31-216-9799
www.sensorcloud.co.kr

Sales contact

info@sensorcloud.co.kr

Technical support

rnd@sensorcloud.co.kr

Made and Printed in Korea

Copyright© 2019. Sensor Cloud, Inc. All rights reserved.