

Data Sheet SMR-313/333

Version 2.0 - 12.06.2018

designed
and manufactured
in Germany

PRODUCT FAMILY

SMT mountable K-Band Movement Sensor

APPLICATIONS

- Industrial Applications
- Security Applications

- Movement
- Velocity
- Direction
- Presence
- Distance
- Angle

FEATURES:

- » Radar-based motion detector working in the 24GHz -ISM - Band
- » Detection of direction and velocity of moving objects
- » Mounting by standard SMT-Process
- » Delivery on Tape & Reel
- » Integrated Low Noise Amplifier
- » Extended temperature range from -40°C up to +85°C
- » Very small outline dimensions
- » Available with different antenna patterns by same interface

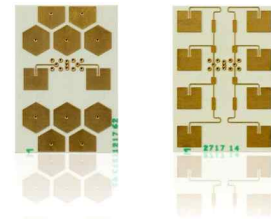

DESCRIPTION

K-Band based motion detector. The ultra small device will be delivered directly on tape for mounting within a standard SMT. Due to the pulse capability the sensor is also suitable for low-power applications.

ETSI / FCC

All SMR modules are compliant to ETSI 300 440. The US Version is compliant to FCC 15.249.

ADDITIONAL INFORMATION

InnoSenT Standard Product. Changes will not be notified as long as there is no influence on form, fit and within this data sheet specified function of the product.

CERTIFICATES

InnoSenT GmbH has established and applies a quality system for: development, production and sales of radar sensors for industrial and automotive sensors.



RoHS-INFO

This product is compliant to the restriction of hazardous substances (RoHS - European Union directive 2011/65/EU).

CONFIDENTIAL AND PROPRIETARY

The information contained in this document shall remain the sole and exclusive property of InnoSenT GmbH and shall not be disclosed by the recipient to third parties without prior consent of InnoSenT in writing.

PARAMETERS

PARAMETER	CONDITIONS	SYMBOL	MIN	TYP	MAX	UNITS
-----------	------------	--------	-----	-----	-----	-------

Radar

transmit frequency	frequency band for US and EU	f	24.150		24.250	GHz
output power (EIRP)		P_{out}			12.7	dBm
IF-Bandwidth (-3dB)		B	0		1M	Hz
signal level (RCS = 0.5m ² @5m)	SMR -313	$IF_{1/2-SMR-313}$	60		250	μ Vrms
	SMR -333	$IF_{1/2-SMR-333}$	120		360	μ Vrms
noise level	100Hz...1kHz	$N_{1/2}$			20	μ Vrms
quadrat. phase imbalance		ϵ_p	-25		25	°
overall gain (conversion gain + antenna gain)	SMR -313	$G_{OA-SMR-313}$		24		dB
	SMR -333	$G_{OA-SMR-333}$		29		dB

Power supply

supply voltage		V_{CC}	3.2	3.3	3.4	V
supply current		I_{CC}		47	57	mA

Environment

operating temperature		T_{OP}	-40		+85	°C
storage temperature		T_{STG}	-40		+85	°C

Mechanical Outlines

outline dimensions	compare to schematic on page 5	height length width		3.1 21.4 15.0		mm
--------------------	--------------------------------	---------------------------	--	---------------------	--	----

CONFIDENTIAL AND PROPRIETARY

The information contained in this document shall remain the sole and exclusive property of InnoSenT GmbH and shall not be disclosed by the recipient to third parties without prior consent of InnoSenT in writing.

ANTENNA PATTERN

System Pattern SMR-313:

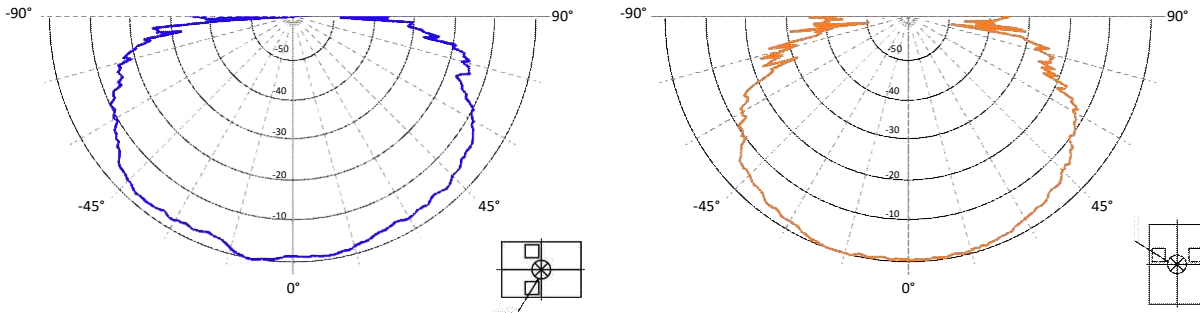

system pattern (-10dB)	azimuth	system_az		121		°
	elevation	system_el		111		°

System Pattern SMR-333:

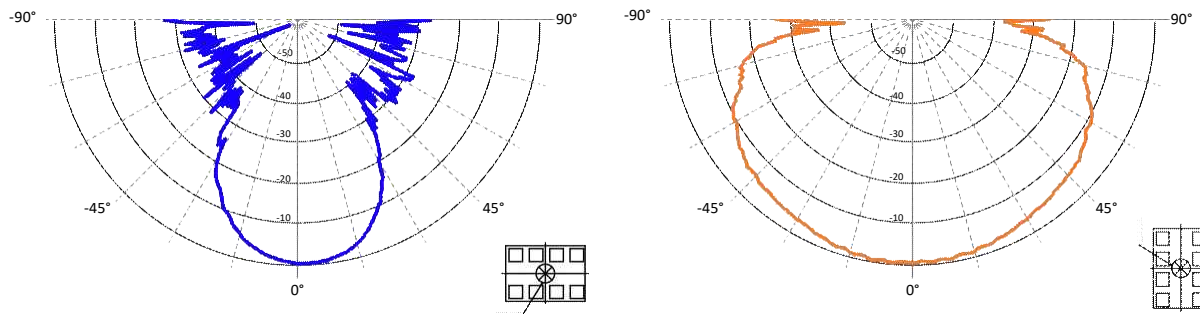

system pattern (-10dB)	azimuth	system_az		43		°
	elevation	system_el		116		°

CONFIDENTIAL AND PROPRIETARY

The information contained in this document shall remain the sole and exclusive property of InnoSenT GmbH and shall not be disclosed by the recipient to third parties without prior consent of InnoSenT in writing.

PULSE SCHEME

In order to use the pulse capability of the SMR the following scheme is recommended to avoid out of band emissions:

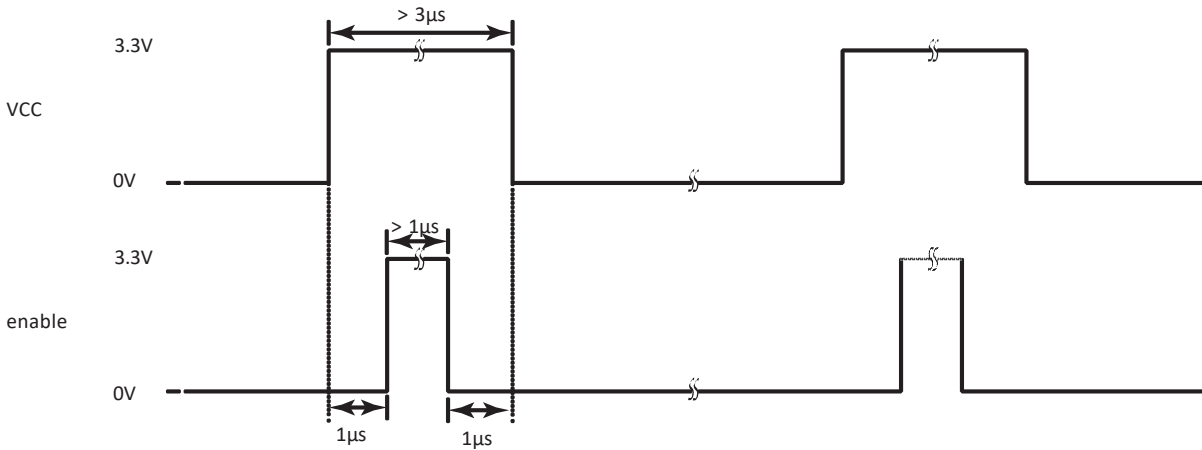

INTERFACE

The sensor provides solder pads for SMT mounting.

PIN #	DESCRIPTION	IN/OUT	COMMENT
1	d.n.c.		do not connect
2	d.n.c.		do not connect
3	IF1	output	signal I(nphase)
4	IF2	output	signal Q(adrature)
5	enable*	input	TX output power enable (active high)
6	GND	input	analog ground
7	V _{cc}	input	supply voltage
8	d.n.c.		do not connect
9	d.n.c.		do not connect
10	GND	input	analog ground

*the enable has no influence on current consumption rather reduces the TX output power by about 30dB. To save power use a pulse scheme as described on page 3.

enable pin off: 0 - 0.8V

enable pin on: 2 - 3.3V

OUTLINE DIMENSIONS

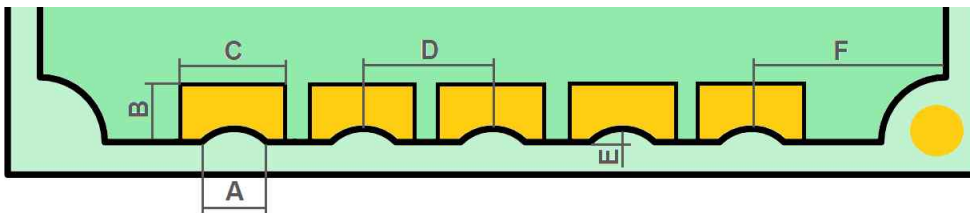
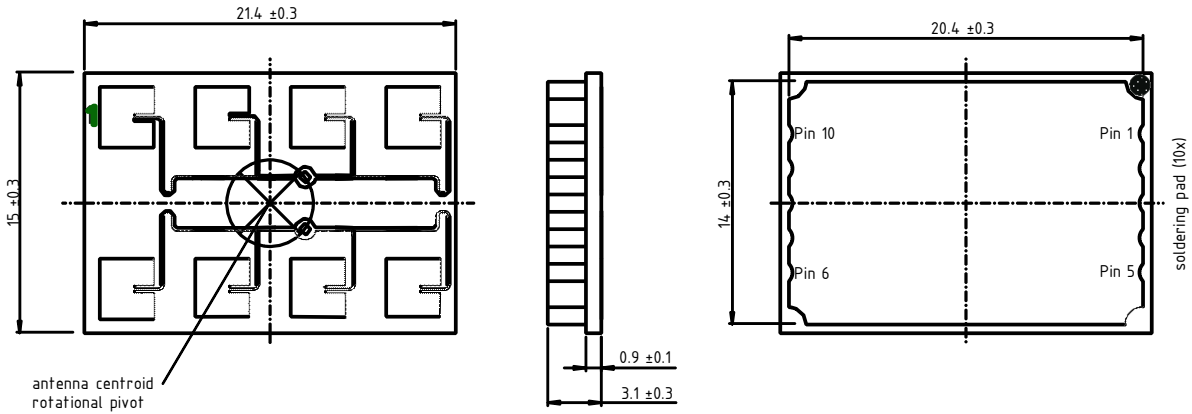

VALUES	DESCRIPTION	DIMENSIONS
A	hole width	1.0 (±0.1)mm
B	SMT Pad depth	0.6 (+0 -0.1)mm
C	SMT Pad width	1.5 (±0.05)mm
D	Pin Pitch	2.0 (±0.05)mm
E	hole depth	0.2 (±0.1)mm
F	distance from center of pin 1 to board edge	2.25 (±0.25)mm

CONFIDENTIAL AND PROPRIETARY

The information contained in this document shall remain the sole and exclusive property of InnoSenT GmbH and shall not be disclosed by the recipient to third parties without prior consent of InnoSenT in writing.

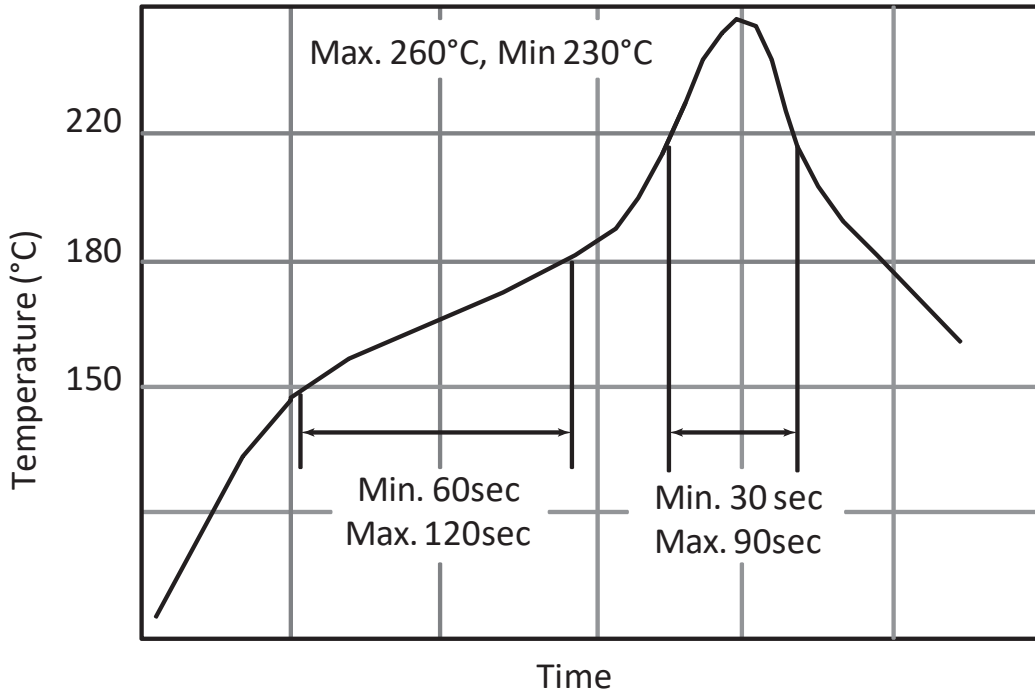

SMT GUIDELINES

The SMR device is 100% Pb-free. Therefore, Pb-free solder paste with a Pb-free re flow profile is recommended. Do not use solder paste with active or acid-based flux. To avoid submerging the device in the solder paste, the placement height (Z) of the device on the pick-and-place equipment should be controlled carefully. Optimally, the Z height should be set at one-half the printed solder paste height. Maintaining board flatness (coplanarity) is important in keeping the Z height under control.

If possible use a pick-and-place machine with a visions-alignment system for proper centering on the PCB.

For the soldering process we recommend the following:

- For optimum results the reflow oven should have nitrogen purge (we recommend 1000ppm)
- To avoid damage during assembly solder re flow attachment, follow the guidelines in IPC/JEDEC J-STD-020D.1. The device is qualified at 260 °C re flow. The following figure shows a typical temperature profile for Pb-free (Sn-Ag-Cu or Sn-Ag) solder and the corresponding critical re flow parameters.
- Assemble the SMR within 5 days after opening the packing
- Not assembled SMR must be dried for 500h at 40 degree Celsius; 1% r.H. before repacking in a dry pack.

CONFIDENTIAL AND PROPRIETARY

The information contained in this document shall remain the sole and exclusive property of InnoSenT GmbH and shall not be disclosed by the recipient to third parties without prior consent of InnoSenT in writing.

PACKAGE FOOTPRINT

Recommended Footprint and Stencil Layout

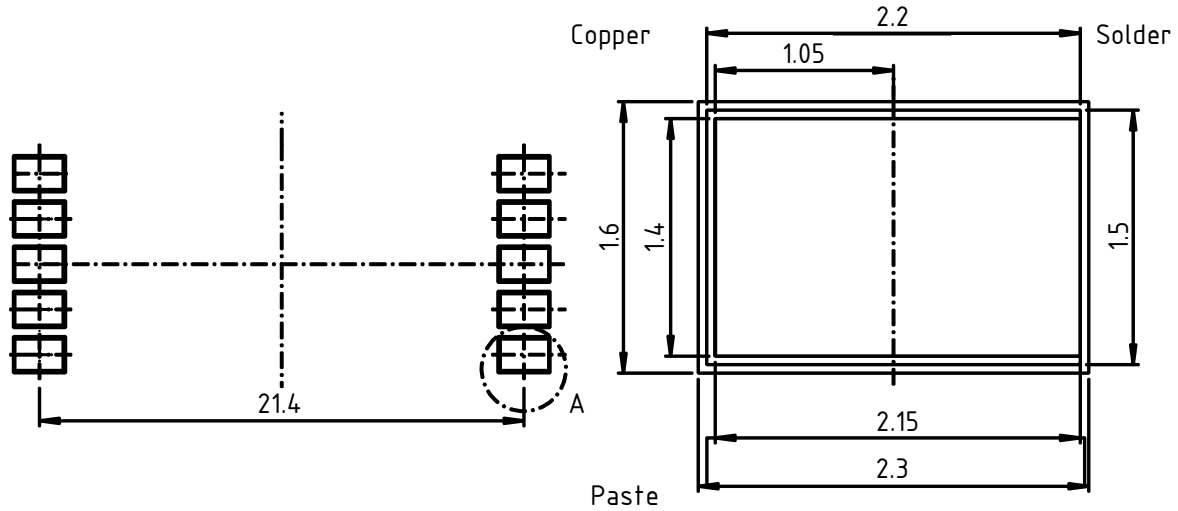

Recommended stencil thickness 225µm

TAPE OF SMR-313/333

The SMR-313/333 will be delivered on tape with a width of 32mm.

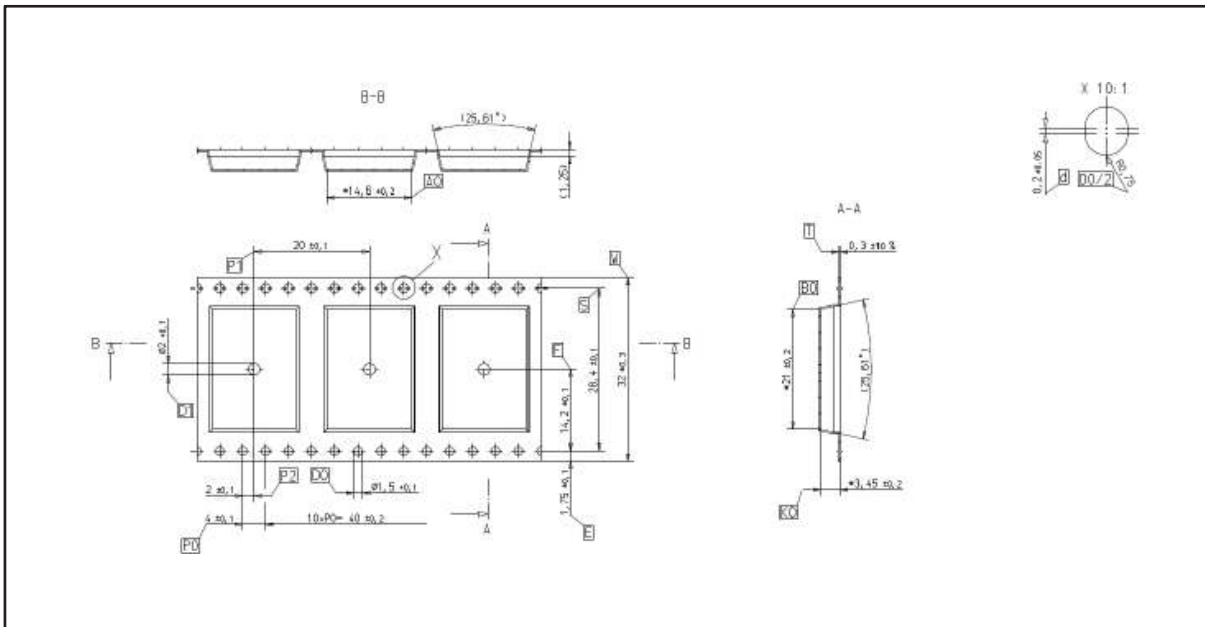

CONFIDENTIAL AND PROPRIETARY

The information contained in this document shall remain the sole and exclusive property of InnoSenT GmbH and shall not be disclosed by the recipient to third parties without prior consent of InnoSenT in writing.

Annex A

The information that will be given below is only a rough overview; for details please contact the local approval agencies. An overview over the frequency bands in Europe can also be found in the REC 70-03 (Annex 6) which is available under www.ero.dk

Frequency Bands in US FCC 15.249

For the US-market the SMR-3X3 can be used

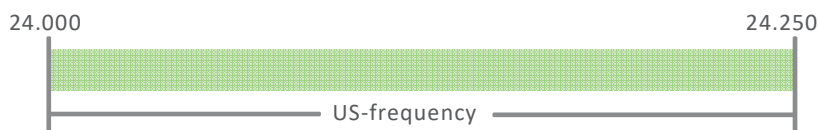

FCC approval

This device complies with Part 15 of the FCC Rules and with RSS-310 of Industry Canada. Operation is subject to the following two conditions:

- (1) this device may not cause harmful interference, and
- (2) this device must accept any interference received, including interference that may cause undesired operation.

Warning: Changes or modifications made to this equipment not expressly approved by InnoSenT GmbH may void the FCC authorization to operate this equipment.

Manufacturers of mobile or fixed devices incorporating SMR3X3 Modules are authorized to use the FCC Grants for their own final products according to the conditions referenced in these documents. In this case, the FCC label of the module shall be visible from the outside, or the host device shall bear a second label stating „Contains FCC ID: UXS-SMR3X3“

Le présent appareil est conforme aux CNR d'Industrie Canada applicables aux appareils radio exempts de licence. L'exploitation est autorisée aux deux conditions suivantes:

- (1) l'appareil ne doit pas produire de brouillage, et
- (2) l'utilisateur de l'appareil doit accepter tout brouillage radioélectrique subi, même si le brouillage est susceptible d'en compromettre le fonctionnement.

NOTICE:

Changes or modifications made to this equipment not expressly approved by (manufacturer name) may void the FCC authorization to operate this equipment.

CONFIDENTIAL AND PROPRIETARY

The information contained in this document shall remain the sole and exclusive property of InnoSenT GmbH and shall not be disclosed by the recipient to third parties without prior consent of InnoSenT in writing.

Frequency Bands in Europe

Generally the SMR-3X3 can be used also for all countries in Europe.

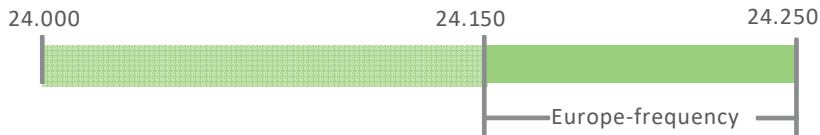

Labeling SMR-3X3

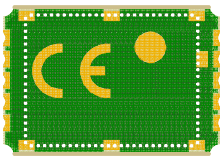

ORDER INFORMATION

	antenna	
	system pattern 121° X111° (1x1 Patch)	system pattern 43° X116° (1x4 Patch)
SMR-313		
SMR-333		

HANDLING PRECAUTIONS

To avoid damage to the devices, care should be exercised during handling. Proper Electrostatic Discharge (ESD) precautions should be observed at all stages of storage, handling, assembly, and testing.

ESD INTEGRITY



ESD Robustness HBM = +/- 1kV according to ANSI/ESDA/JEDEC JS-001 (R = 1.5kOhm, C = 100pF) for Electrostatic Discharge Sensitivity Testing, Human Body Model (HBM)-Component Level; CDM = +/- 500V according to JEDEC JESD22-C101 Field-Induced Charged Device Model (CDM), Test Method for Electrostatic-Discharge-Withstand Thresholds of Microelectronic Components.

CONFIDENTIAL AND PROPRIETARY

The information contained in this document shall remain the sole and exclusive property of InnoSenT GmbH and shall not be disclosed by the recipient to third parties without prior consent of InnoSenT in writing.

APPROVAL

This Data Sheet contains the technical specifications of the described product. Changes of the specification must be in written form. All previous versions of this Data Sheet are no longer valid.

VERSION	DATE	COMMENT
1.0	08.04.2016	initial release
1.1	26.07.2016	Data matrix code in outline dimensions removed
1.2	06.03.2017	changing recommended footprint; addition information in interface
1.3	16.06.2017	adding label
1.4	21.09.2017	changing frequency band information
1.5	06.10.2017	changing frequency band information
1.6	14.11.2017	changing transmit frequency condition
1.7	20.12.2017	changing recommended footprint
1.8	13.02.2018	remove SMR-323; changing frequency band and handling information
1.9	20.04.2018	adding in mechanical
2.0	12.06.2018	changing order information (system pattern)



TIONE Co.,ltd
 Republic of Korea

Tel: 82-070-7576-3428
 E-Mail: tione@tione.kr
 URL: www.tione.kr