

DATA SHEET for LED DISPLAY

YDSR-1032K(A)M

Part No.	Dice Color
YDSR-1032K(A)M	Super Red
Color of Segment	Surface Color
White Diffused	Black
Internal Circuit Diagram	Package Dimensions

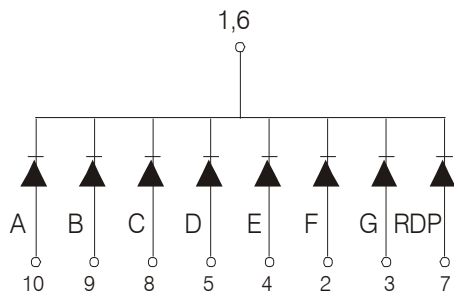
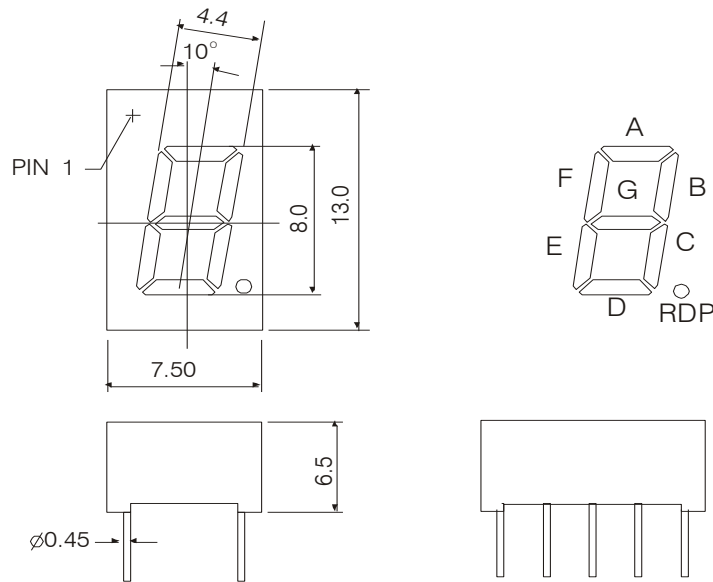

YDSR-1032KM

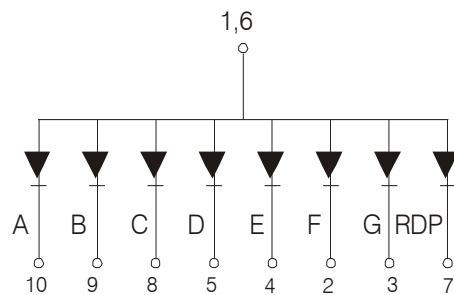

YDSR-1032AM

Absolute Maximum Rating of Each Segment (Ta=25°C)

Parameter	Symbol	Maximum Rating	Unit
Power Dissipation	P _M	65	mW
Continuous Forward Current	I _F	25	mA
Reverse Voltage	V _R	5	V
Operation Temperature	T _{opr}	-20°C ~ 70°C	°C
Storage Temperature	T _{stg}	-20°C ~ 85°C	°C

Electron-Optical Characteristics of Each Segment (Ta=25°C)

Parameter	Symbol	Min.	Typ.	Max.	Unit	Test Condition
Luminous Intensity	I _v	3.5	5.5		mcd	I _F =20mA
Forward Voltage	V _F		1.8	2.3	V	I _F =20mA
Reverse Current	I _R			20	μA	V _R =5V
Peak Wavelength	λ _p		660		nm	I _F =20mA