

CUSTOMER : _____

SPECIFICATION

SHEET NO.

1 OF 10

DATE

2016-09-01

PART NAME

Radial Inductor

MODEL NAME

DR2-102K-B & T

PART NO.

DR2)1mH(102K)

DESCRIPTION

DR 6.5X7.5mm

1. GENERAL SPECIFICATION

1) SCOPE

This specification applies to part number 1mH PEAKING COIL for use in electronic appliances which is supplied for

2. MECHANICAL CHARACTERISTIC

PEAKING COIL shall conform in size, dimension, and other mechanical properties, to the part drawing attached here to.

1) Marking

PEAKING COIL shall be permanently and legibly marked with the part number on the specification position.

2) Terminal strength

Terminal shall withstand for 30 seconds without breakdown on losing when a static load of 2 Kg is applied in the drawing direction to the terminal at the point where the external load.

3. ENVIRONMENTAL & LIFECHARACTERISTIC

1) Temperature rise

Temperature rise of the each winding and core shall be less than ambient + 65°C , when the PEAKING COIL continuously operated at full load(test load) until constant temperature is attained.

2) Heat-resistance

Immediately after PEAKING COIL being placed in room for 96 Hours maintained AT 105°C ± 2°C ambient temperature, the PEAKING COIL shall conform with the above part paragraph (4) and also insulation resistance shall be more than 100 MΩ.

3) Moisture resistance



Immediately after PEAKING COIL being placed in room for 120 Hours in such humidity chamber this is maintained at 90 - 95% relative humidity and 55°C ± 2°C temperature and wiped a drop of water, PEAKING COIL shall conform with the above paragraph(4) and also insulation shall be the 10 MΩ.

4) Safety consideration

PEAKING COIL shall meet all the requirements subject to IEC-950 standards for safety of information technology equipment including electrical business equipment.

5) Solderability

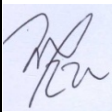
Dip pads in RMA flux, 96.5/0.5/3 solder (Sn/Cu/Ag)at 260°C for 5±2 seconds

NO	REVISION	DATE	CHECK	DRAWN	CHECKED	APPROVED
1						
2						
3						
4						

CUSTOMER : _____

SPECIFICATION

SHEET NO.

2

OF

10

DATE

2016-09-01

PART NAME

Radial Inductor

MODEL NAME

DR2-102K-B & T

PART NO.

DR2)1mH(102K)

DESCRIPTION

DR 6.5X7.5mm

4. APPEARANCE & DIMENSION (UNIT:m/m)

<Bulk type>

EPOXY COLOR

GREEN

<TOP VIEW>

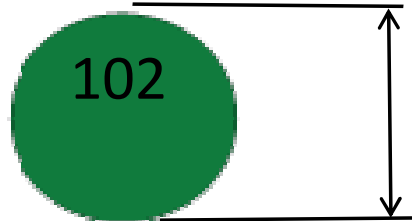

7.8 MAX

MARKING :102 or 102K

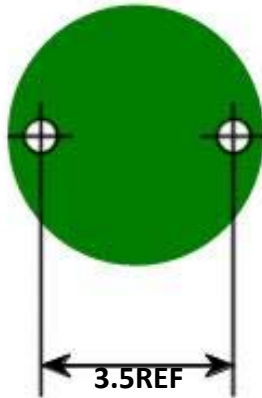

3.5 REF

1.5 MAX

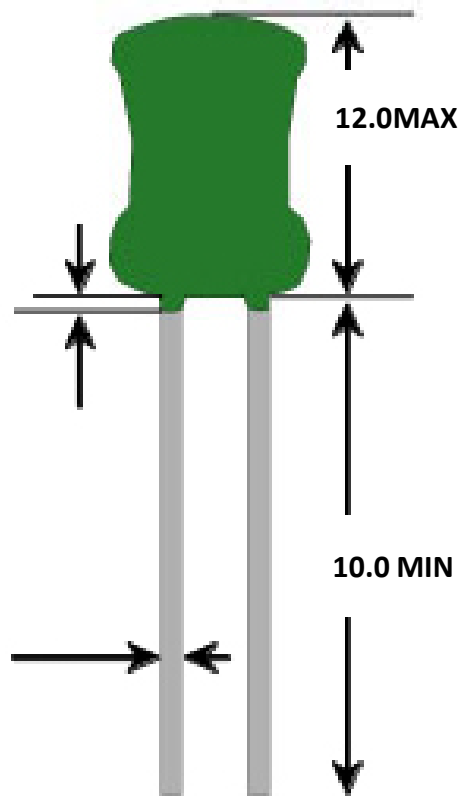

12.0 MAX

10.0 MIN

0.5 REF

NO	REVISION	DATE	CHECK	DRAWN	CHECKED	APPROVED
1						
2						
3						
4						

CUSTOMER : _____

SPECIFICATION

SHEET NO. 3 OF 10

DATE 2016-09-01

PART NAME Radial Inductor MODEL NAME DR2-102K-B & T

PART NO. DR2)1mH(102K) DESCRIPTION DR 6.5X7.5mm

4. APPEARANCE & DIMENSION (UNIT:m/m)

<Taping type>

EPOXY COLOR

GREEN

MARKING :102 or 102K

<TOP VIEW>

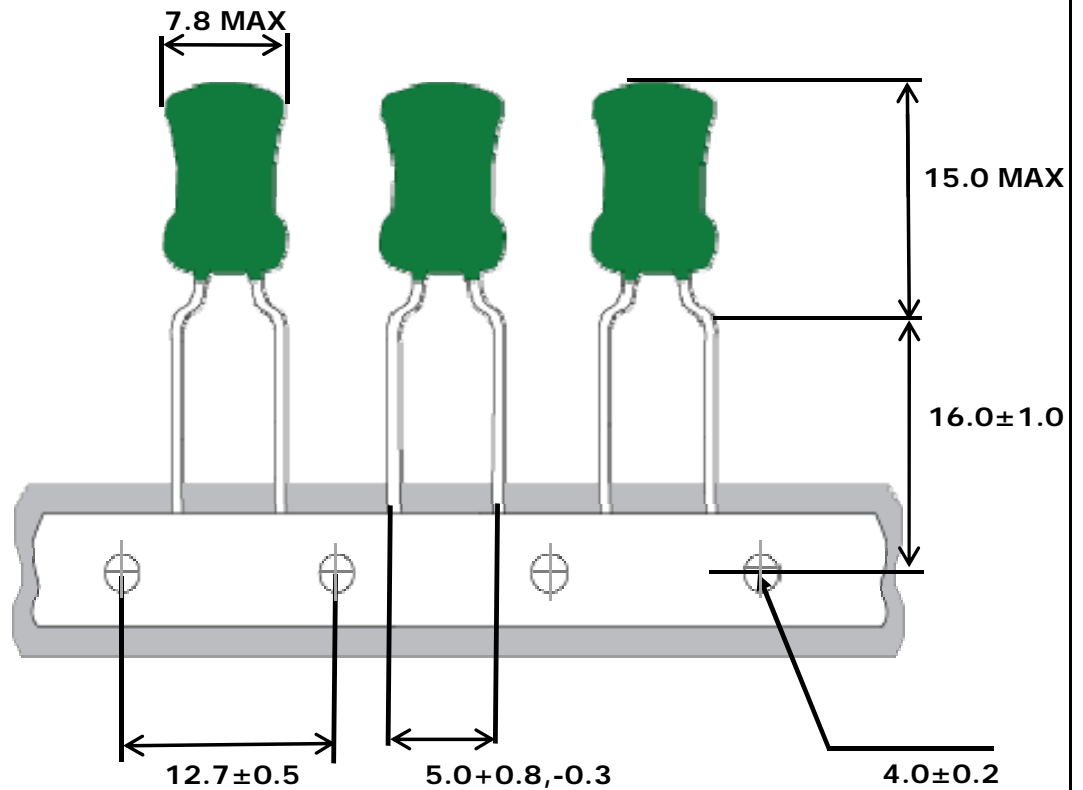
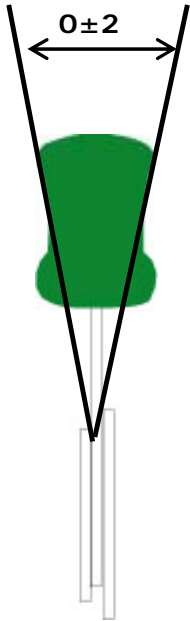
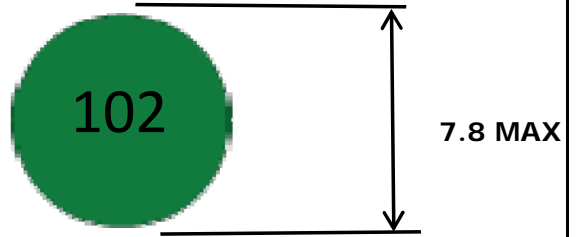

NO	REVISION	DATE	CHECK	DRAWN	CHECKED	APPROVED
1						
2						
3						
4						

CUSTOMER : _____

SPECIFICATION

SHEET NO. 4 OF 10

DATE 2016-09-01

PART NAME Radial Inductor MODEL NAME DR2-102K-B & T



PART NO. DR2)1mH(102K) DESCRIPTION DR 6.5X7.5mm

5. WINDING SPEC

	TYPE OF WIRE	TURNS	WINDING METHODE
START & FINISH	2UEW 0.16Φ	185.5 Ts REF	SOLENOID WINDING [C . C . W]

6. ELECTRICAL CHARACTERISTIC

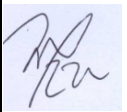
NO	ITEM	MESURE	SPECIFICATION	REMARKS
1	INDUCTANCE	START & FINISH	1[mH] ± 10%	HIOKI3522 LCR METER at 1kHz 1V
2	DC RESISTANCE	START & FINISH	3.0[Ω] MAX	WHEATSTONE BRIDGE TYPE 2755
3	DIELECTRIC WITHSTANDING TEST	COIL & CORE	AC 1 [KV] , FREQUANCY 60 [Hz] , 1 MINUTES, CUT OFF CURENT 2 [mA]	KIKUSUI TOS5302

NO	REVISION	DATE	CHECK	DRAWN	CHECKED	APPROVED
1						
2						
3						
4						

CUSTOMER : _____

SPECIFICATION

SHEET NO. 5 OF 10

DATE 2016-09-01

PART NAME Radial Inductor MODEL NAME DR2-102K-B & T

PART NO. DR2)1mH(102K) DESCRIPTION DR 6.5X7.5mm

7. SCHEMATIC DIAGRAM

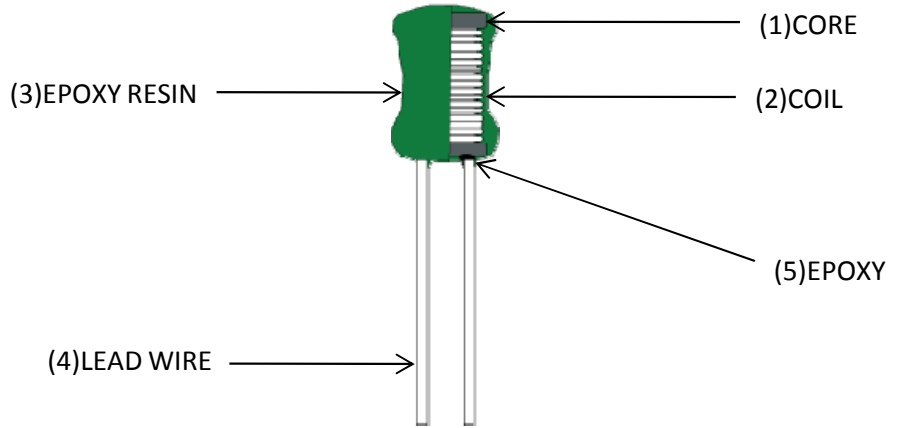
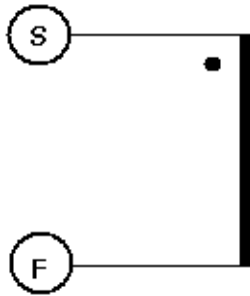

8. MATERIAL LIST

NO	ITEM	MATERIAL & DIMENSION	MANUFACTURE	REMARK
1	CORE	JA3 DR 6.5X7.5mm	JIACI(ZHUHAI)ELECTRONICS CO.,LTD.	EQV
2	WIRE	2UEW 0.16Φ	CNI CABLE CO., LTD. CHUNYI ELECTRICAL APPLANCES CO.,LTD.	E210918 E198440 EQV
3	EPOXY RESIN	EPI-CHEM 930HF	SAMSIN CHEMICAL CO.,LTD.	E232031 EQV
4	LEAD WIRE	TPC 0.6Φ	KISTRON CO.,LTD YEHUA CO.,LTD	EQV
5	EPOXY	EPI CHEM-2001HS FK661	SAMSIN CHEMICAL CO.,LTD. QIFU ELECTRONIC MATERIALS FACTORY	EQV
-	SOLDER BAR	HSE-09 SC00	HEESUNG MATERIAL LTD. HANHUA TIN CO.,LTD.	EQV
-	FLUX	F181	ZHUHAI FRIEND INDUSTRIAL CO.,LTD.	EQV
-	INK	299BK HC-6519	DOMINO KOREA CO.,LTD. CANTON XING CHUANG CODING EQUIPMENT CO.,LTD.	EQV

9. TABLE OF STANDARD CHARACTERISTICS OF MATERIALS

PROPEY UNIT	μiac	Bms	Br	WORKING	Tc
MATERIAL	±25%	GAUSS	GAUSS	Frequency(MHZ)	℃
JA3	300	2400	1300	0.1~2.0	150

NO	REVISION	DATE	CHECK	DRAWN	CHECKED	APPROVED
1						
2						
3						
4						

NAMSUN ELECTRONICS CO.,LTD.

CUSTOMER : _____

SPECIFICATION		SHEET NO.	6 OF 10
		DATE	2016-09-01
PART NAME	Radial Inductor	MODEL NAME	DR2-102K-B & T
PART NO.	DR2)1mH(102K)	DESCRIPTION	DR 6.5X7.5mm

10. REMARK-2 / DONG YANG [UL CARD]

OBMW2.E210918 - Magnet Wire - Component 페이지 1 / 2

 **ONLINE CERTIFICATIONS DIRECTORY**

OBMW2.E210918
Magnet Wire - Component

Page Bottom

Magnet Wire - Component



See General Information for Magnet Wire - Component

CNICABLE CO LTD E210918
312-16 DEUKSAN-DONG
ASAN-SI, CHUNGCHONGNAM-DO 336-120 REPUBLIC OF KOREA

Mtl Dsg	Mark Dsg	Coat Type		ANSI Type	Temp Class
		BC	OC		
DSUEW-100	(1)	Polyurethane	—	MW75C	130#
UEW	(1)	Polyurethane	None	MW79	155
				MW75	130#
PEW	(1)	Polyester	None	MW30	180
				MW5	155#
AAI-EIW	(1)	Polyesterimide	Polyamide-imide	—	200
AI-EIW(R)	(1)	Polyesterimide	Polyamide-imide	@	220
AI-EIW(SL)	(1)	Polyesterimide	Polyamide-imide	@	220
			(self-lubricating)		
AIW	(1)	Polyesterimide	Polyamide-imide	—	200
AL-UEW	(1)	Polyurethane	—	—	155
EIW	(1)	Polyesterimide	—	—	200
HSRW	(1)	Polyesterimide	Polyamide-imide	MW73C,MW35C	200
MW35	(1)	Polyesterimide	Polyamide-imide	MW73C,MW35C	200
MW35A	(1)	Polyesterimide	Polyamide-imide	MW35A	220
NPW	(1)	Polyester	Polyamide	MW76	180
				MW24	155
PEW	(1)	Polyester	—	MW5	155
UEW	(1)	Polyurethane	—	MW79	155
NUW	(1)	Polyurethane	Polyamide	MW83,	180
				MW80	155

Mtl Dsg	Coat Type			ANSI Type	Temp Class
	BC	OC	Bond		
SB-EIW	Polyester-imide	—	Polyamide	@	200
AI-EIW(I)	Esterimide	Filled	Amide-imide	@	200
			amide-imide		

<http://database.ul.com/cgi-bin/XYV/template/LISEXT/1FRAME/showp...> 2006-11-21

NO	REVISION	DATE	CHECK	DRAWN	CHECKED	APPROVED
1						
2						
3						
4						

CUSTOMER : _____

SPECIFICATION

SHEET NO.

7 OF 10

DATE

2016-09-01

PART NAME

Radial Inductor

MODEL NAME

DR2-102K-B & T

PART NO.

DR2)1mH(102K)

DESCRIPTION

DR 6.5X7.5mm

10. REMARK-3 / CHUNYI [UL CARD]

OBMW2.E198440 - Magnet Wire - Component 페이지 1 / 2

 **ONLINE CERTIFICATIONS DIRECTORY**

**OBMW2.E198440
Magnet Wire - Component**

Page Bottom



Magnet Wire - Component

See General Information for Magnet Wire - Component

GUANGZHOU CHUNYI ELECTRIC ENTERPRISE LTD E198440
 RM 348 FULI YINGFENG MANSION
 NO 2 HUAQIANG RD ZHUJIANG XINCHENG
 TIANHE DISTRICT
 GUANGZHOU, GUANGDONG 528222 CHINA

Mtl Dsg	Coating Type		ANSI Type	TI
	BC	TC		
JEC-XPEW(QZ)	Polyester	—	—	155#
JEC-XUEW(QA)	Polyurethane	—	—	130#
JEC-X(EIW-AL/200) Q(ZY/XY)/200	Polyester-imide	Polyamide-imide	MW35C, MW73C	200
JEC-XUEW/155(QA/155)	Polyurethane	—	MW79C	155
UEW or QA-	Polyurethane	—	MW82-C	180
	Polyurethane	—	MW79-C@	155
	Polyurethane	—	MW75-C@	130
UEW(AL) or QA(L)-	Polyurethane	—	—	180
	Polyurethane	—	@	155
	Polyurethane	—	@	130
UEW/NY or QA/NY-	Polyurethane	Polyamide	MW83-C	180
	Polyurethane	Polyamide	MW80-C@	155
	Polyurethane	Polyamide	MW28-C@	130
	Polyurethane	Polyamide	—	180
	Polyurethane	Polyamide	MW80-A@	155
UEW/NY(AL) or QA/NY(L)-	Polyurethane	Polyamide	MW28-A@	130
	Polyester-imide	—	MW74-C	200
EIW or QZY-	Polyester-imide	—	MW30-C@	180
PEW or QZ-	Polyester-imide	—	MW5-C	155
QZ-*	Polyester-imide	—	@	130
EIW(AL) or QZY(L)-	Polyester-imide	—	MW74-A	200
	Polyester-imide	—	@	180
PEW (AL)or QZ(L)-	Polyester-imide	—	@	155
QZ(L)-*	Polyester-imide	—	@	130
PEW/NY or QZ/NY-	Polyester	Polyamide	MW76-C	180
	Polyester	Polyamide	MW24-C@	155
	Polyester	Polyamide	@	130
PEW/NY(AL)or QZ/NY(L)-	Polyester	Polyamide	MW76-A	180
	Polyester	Polyamide	MW24-A@	155

<http://database.ul.com/cgi-bin/XYV/template/LISEXT/1FRAME/showpage.html?name=OBMW2.E19...> 2011-05-07

NO	REVISION	DATE	CHECK	DRAWN	CHECKED	APPROVED
1						
2						
3						
4						

CUSTOMER : _____

SPECIFICATION

SHEET NO. 9 OF 10

DATE 2016-09-01

PART NAME	Radial Inductor	MODEL NAME	DR2-102K-B & T
PART NO.	DR2)1mH(102K)	DESCRIPTION	DR 6.5X7.5mm

11. PACKING SPECIFICATION

ITEM	INNER BOX(PCS)	OUT BOX(PCS)
DR2-102K-T	1,500	7,500

INNER BOX : 340L*255W*50H(PUT 1500EA IN ONE INNER BOX)



PRODUCTION LABEL

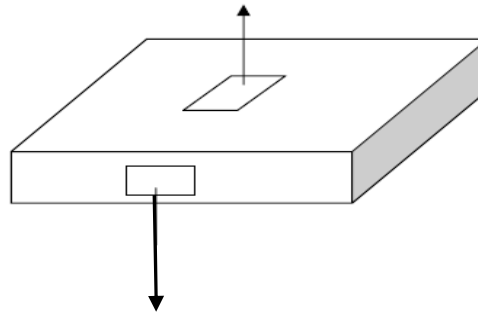

ITEM NO : DR2)1mH
 CODE NO : DR2-102KT
 Q, TY : 1,500PCS
 LOT NO : NS-F7091
 NAMSUN ELECTRONICS CO.,LTD.

OUT BOX : 360L*265W*285H(PUT IN FIVE INNER BOX)

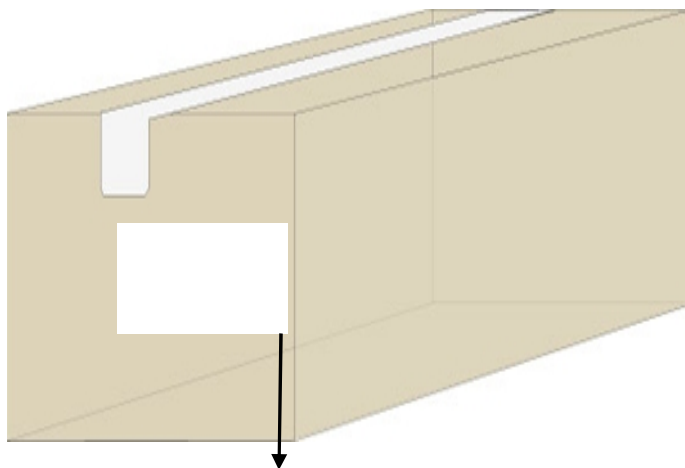

LABEL

NO	REVISION	DATE	CHECK	DRAWN	CHECKED	APPROVED
1						
2						
3						
4						

CUSTOMER : _____

SPECIFICATION

SHEET NO. 10 OF 10

DATE 2016-09-01



PART NAME Radial Inductor MODEL NAME DR2-102K-B & T

PART NO. DR2)1mH(102K) DESCRIPTION DR 6.5X7.5mm

12. INSPECTION DATA

NO	INDUCTANCE	DC RESISTANCE	내전압	절연저항
SPEC	1[mH] ± 10%	3.0[Ω] MAX	AC 1KV 1분 MIN	DC 500V 100MΩMIN
1	1.02	2.2	OK	OK
2	1.01	2.1	OK	OK
3	1.01	2.1	OK	OK
4	1.03	2.1	OK	OK
5	1.03	2.1	OK	OK
6	1.02	2.2	OK	OK
7	1.02	2.2	OK	OK
8	1.02	2.1	OK	OK
9	1.00	2.1	OK	OK
10	1.01	2.1	OK	OK
X	1.017	2.13		
MIN	1.00	2.1		
MAX	1.03	2.2		

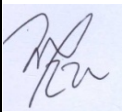
REMARK

NO	REVISION	DATE	CHECK	DRAWN	CHECKED	APPROVED
1						
2						
3						
4						